



 **DRAINAGE**

SABdrain



01.2023

 **SAB**
cherish your water
 **SYSTEM GROUP**

CHERISH YOUR WATER MANIFESTO

Ci prendiamo cura dell'acqua. Con il nostro manifesto vogliamo stabilire valori, processi e soluzioni concrete per promuovere un uso efficiente e consapevole dell'acqua.

We cherish your water. With this notice we want to establish values, processes and concrete solutions to promote an educated and efficient use of water.

- 1 L'acqua è vita**
Water is life
- 2 L'acqua è una risorsa scarsa**
Water is a scarce resource
- 3 Promuoviamo l'uso consapevole dell'acqua**
We promote a conscious use of water
- 4 Cerchiamo di rendere l'acqua accessibile per abbattere le disuguaglianze**
We try to make water more accessible in order to reduce inequalities
- 5 Etica aziendale e trasparenza**
Corporate ethics and transparency
- 6 Ricerca e sviluppo di nuovi prodotti**
Research and development of new products
- 7 Scelta e lavorazione delle materie prime**
Raw materials choice and processing
- 8 Tecniche di produzione**
Production techniques
- 9 Vendite, servizi e customer care**
Sales, service and customer care
- 10 Servizi e responsabilità sociale**
Social responsibility services



CHI SIAMO | WHO WE ARE

Lavoriamo per sviluppare prodotti performanti, affidabili e semplici da usare, che possano contribuire a rendere più semplice il lavoro degli installatori e degli agricoltori. Siamo presenti con la nostra ampia gamma in tre settori: **irrigazione, acqua & gas, drenaggio**.

We work to develop high-performance and simple-to-use products that can help make the work of installers and farmers easier. We are active in three sectors: **irrigation, water and gas, and drainage**.



INNOVAZIONE INNOVATION

68% del fatturato proviene da **prodotti lanciati o rinnovati** negli ultimi 5 anni
68% of our turnover comes from **products launched or renovated** in the last 5 years



QUALITÀ QUALITY

13 certificati internazionali e severi test di laboratorio
13 international certificates and strict laboratory tests



AFFIDABILITÀ RELIABILITY

72% del fatturato viene realizzato con **clienti fedeli da oltre 10 anni**
72% of our turnover has been achieved with **customers loyal for over 10 years**



SOSTENIBILITÀ SUSTAINABILITY

Certificazione Internazionale Ecovadis medaglia d'argento
Ecovadis international certification - silver medal

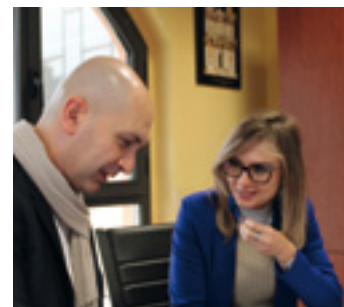



System Group è uno dei principali gruppi italiani ed europei nella fornitura di soluzioni per la costruzione di reti interrate per il convogliamento di fluidi e protezione cavi mediante tubi, raccordi e componenti in PE, PP e PVC. Il gruppo nasce nell'entroterra pesarese dall'idea dell'imprenditore Alvaro Boscarini che nel 1979 fonda Centraletubi. System Group ha una struttura capillare e integrata e supporta i suoi clienti nella progettazione, consulenza e nella fornitura di soluzioni tecniche innovative.



Codice Etico e Bilancio di Sostenibilità System Group

Tutte le Aziende di System Group seguono i principi e le indicazioni, soprattutto per quanto riguarda i valori etici e morali nella conduzione del business, sanciti nel Codice Etico di Gruppo.

System Group ha presentato il Bilancio di Sostenibilità, che riunisce, a livello di principi generali, tutte le Aziende del Gruppo, e che prevede, per alcune di esse, la redazione del Bilancio secondo i GRI Standard 2021, certificato da ente terzo accreditato, per rendicontare agli stakeholders i propri impatti economici, ambientali e sociali (ESG) e definire le proprie strategie sulla sostenibilità d'impresa.



System Group is one of the leading Italian and European groups in the supply of solutions for underground networks involving fluids and cable protection by means of pipes, fittings and components in PE, PP and PVC.

It was created in a small town inland of Pesaro (ITALY) as a result of an idea by entrepreneur Alvaro Boscarini who, in 1979, had founded Centraletubi. Having a diffuse and integrated structure, System Group supports its customers in the design, consultancy and supply of innovative technical solutions.



System Group Code of Ethics and Sustainability Report

All System Group companies follow the principles and guidelines, especially with regard to ethical and moral values in the conduct of business, enshrined in the Group's Code of Ethics.

System Group has presented the Sustainability Report, which brings together, at the level of general principles, all the Companies of the Group, and which envisages, for some of them, the preparation of the Report according to GRI Standard 2021, certified by an accredited third party, in order to report to the stakeholders on their economic, environmental and social (ESG) impacts and to define their strategies on corporate sustainability.



QUALITY



APPROVALS



Product approvals



Testing Lab

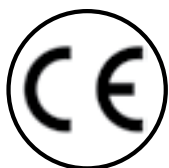

CE mark



INDEX

		I dettagli che fanno la differenza	06
		Details that make the difference	
		Classi di carico	07
		Load classes	
Do it Yourself	A15 B125	Canale PP e griglia a fessura in PP, acciaio zincato e ghisa sferoidale	08
		PP channel and PP slotted grid, galvanized steel and cast iron	
	A15 B125	Kit Sabdrain e accessori	10
		Sabdrain Kit and accessories	
	A15	Canale PP e griglie a fessura in PP	12
		PP channel and PP slotted grids	
	B125 C250	Canale PP e griglie a fessura in PAFV	14
		PP channel and PAGF slotted grids	
	B125 C250	Canale PP bordi acciaio e griglie a fessura in PAFV	16
		Steel edged PP channel and PAGF slotted grids	
	A15	Canale PP e griglia a fessura in acciaio zincato	18
		PP channel and galvanized steel slotted grid	
	B125	Canale PP e griglie a maglia 33x11 e 33x33 in acciaio zincato	20
		PP channels and galvanized steel netted grids 33x11 and 33x33	
	B125	Canale PP bordi acciaio e griglie a maglia 33x11 e 33x33 in acciaio zincato	24
		Steel edged channel and galvanized steel netted grids 33x11 and 33x33	
	C250	Canale PP e griglie a fessura in ghisa sferoidale	28
		PP channel and cast iron grids	
	C250	Canale PP bordi acciaio e griglie a fessura in ghisa sferoidale	30
		Steel edged PP channel and cast iron grids	
	D400	Canale PP bordi acciaio e griglie a fessura in ghisa sferoidale	32
		Steel edged PP channel and cast iron grids	
	F900	Canale PP bordi acciaio e griglie a fessura in ghisa sferoidale	34
		Steel edged PP channel and cast iron grids	
	C250 D400 F900	Canale PP bordi acciaio e griglia a fessura in ghisa sferoidale	36
		Steel edged PP channel and cast iron grid	
Heel Guard	C250	Canale PP bordi acciaio e griglie a fessura in ghisa sferoidale	38
		Steel edged PP channel and cast iron grids	
	C250	Canale PP bordi acciaio e griglia a fessura in ghisa sferoidale	40
		Steel edged PP channel and cast iron grid	
	C250	Canale PP e griglia a fessura in acciaio zincato	42
		PP channel and steel slot grid	
	A15 B125 C250	Pozzetto PP con bordi in plastica	44
		Plastic edged PP drain box	
	B125 C250 D400 F900	Pozzetto PP con bordi in acciaio	46
		Steel edged PP drain box	
		Accessori	48
		Accessories	
		Grigliato per prati in PE Grab	50
		PE grass saver Grab	
		Embrice per canali di scolo in PP Canyon	51
		PP water run-off channel Canyon	
		Posa in opera	52
		Installation	



1 Incastro Connection



Il sistema di incastro maschio femmina
Male/female embedding system
Le système d'emboîtement male/femelle
Sistema de empalme macho/hembra

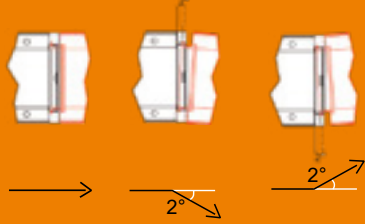

3 Incastro laterale Lateral connection



La predisposizione per l'incastro a 90°
90° embedding presetting
La predisposition pour l'emboîture à 90°
Predisposición para el empalme a 90°

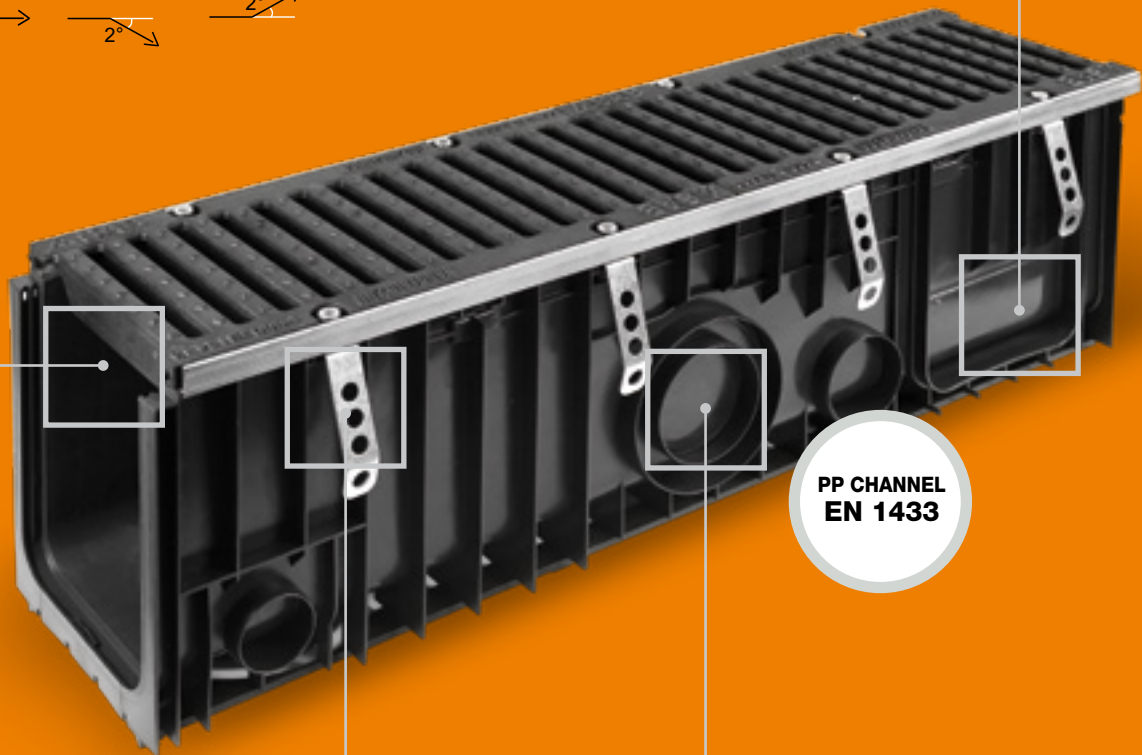

**PP CHANNEL
EN 1433**

2 Ancoraggio Anchorage



L'ancoraggio delle griglie
The anchorage of the grids
L'ancrage des grilles
Anclaje de las rejillas



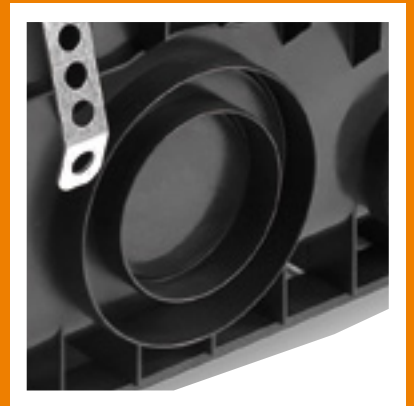

4 Collegamento tubi Pipes connection

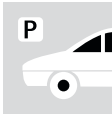
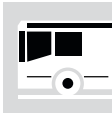

Le predisposizioni per il collegamento dei tubi
Preset pipe connections
Les predispositions pour la liaison des tuyaux
Predisposiciones para el enlace de las tuberías

Scegliete il vostro canale sabdrain in base alla classe di carico necessaria
Choose your sabdrain channel according to the suitable load class

Classi - Class - Classe - Clase

Classe - Class Classe - Clase	Resistenza - Resistance Resistance - Resistencia	Impiego - Use - Emploi - Uso
 A15	15 kn 1500 kg	Aree pedonali, piste ciclabili, zone verdi Pedestrian precincts, cycle-lanes, parks Zones pour piétons, pistes cyclables, espaces verts Área peatonal, carril de bicicletas, Áreas verdes
 B125	125 kn 12500 kg	Marcialedi, aree di sosta, parcheggi multipiano Sidewalks, lay by, multilevel car parks Trottoirs, aires de stationnement, parking à multi étages Andenes, áreas de paradas, estacionamientos cerrados
 C250	250 kn 25000 kg	Fascia che va da 50cm di carreggiata a 20cm sul marciapiede Strip that extends from 50cm of the carriageway to 20cm on the sidewalk Bande qui est à 50cm de la chaussée et à 20cm du trottoir Tira que va de 50cm de carretera a 20cm del andén
 D400	400 kn 40000 kg	Carreggiata di strade ed autostrade Carriageway of roads and highways Chaussée de routes et autoroutes Calzada de carreteras y autopistas
 E600	600 kn 60000 kg	Zone industriali e portuali adibite a scarico merci pesanti Industrial and harbour sites used for heavy loading Zone industrielles et portuaires destinées aux décharges de marchandise lourdes Zonas industriales y portuarias destinadas a la descarga de material pesado
 F900	900 kn 90000 kg	Aeroporti, basi militari, zone sottoposte ad elevati carichi in genere Airports, army bases, heavy loading areas. Aéroports, bases militaires, zones soumises aux charges élevées Aeroportos, bases militares, zonas sometidas a elevadas cargas en general

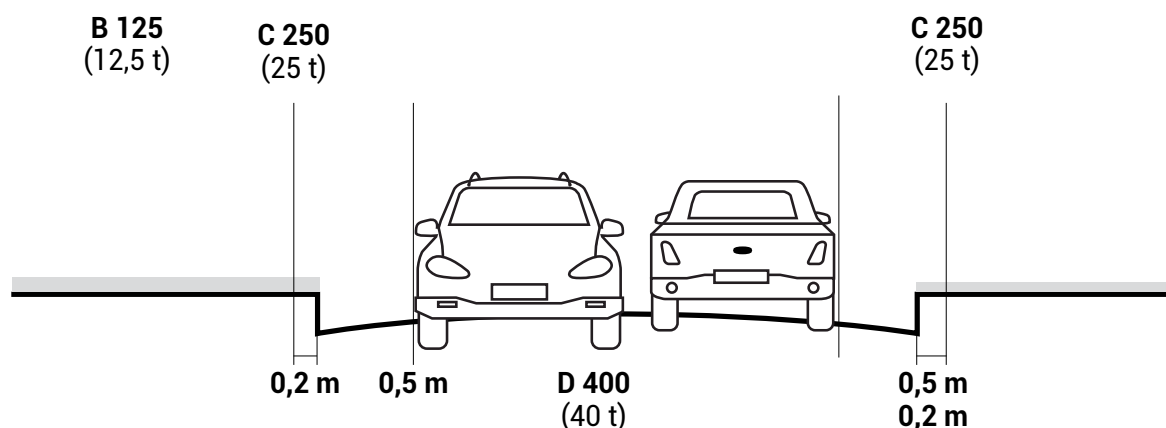

CODE
17 352A



A15



// Price list

Do It Yourself



- n.1** Canale PP con bordi in plastica
n.2 Griglie a fessura in PP

Plastic edged PP channel
PP slotted grids

Caniveau Brico en PP avec bordures plastique
Grilles passerelles en PP

Canal de PP con bordes de plástico
Rejillas ranuradas de PP

CODE	L x H	L1 x H1	kg	pack	€/m	€/m	€/m	€/m
517 1005 352AP	100 x 50	125 x 67	1,5	136	20,20	9,90	10,30	/
517 1010 352AP	100 x 100	125 x 117	1,9	80	23,30	13,00	10,30	/

CODE
17 508A



A15



- n.1** Canale PP con bordi in plastica
n.1 Griglia a fessura acciaio zincato

Plastic edged PP channel
Galvanized steel slotted grid

Caniveau Brico en PP avec bordures plastique
Grille passerelle en acier galvanisé

Canal de PP con bordes de plástico
Rejilla ranurada de acero galvanizado

CODE	L x H	L1 x H1	kg	pack	€/m	€/m	€/m	€/m
517 1005 508AZ	100 x 50	125 x 67	2,0	136	23,80	9,90	13,90	/
517 1010 508AZ	100 x 100	125 x 117	2,4	80	26,90	13,00	13,90	/

CODE
17 705B



B125



- n.1** Canale PP con bordi in plastica
n.2 Griglie in ghisa sferoidale
n.1 Fissaggio
n.2 staffe in PA
n.2 viti M8x25

Plastic edged PP channel
Cast iron grids
Fix kit
n. 2 PA clamps
n. 2 screws M8x25

Caniveau Brico en PP avec bordures plastique
Grilles en fonte
Kit de fixation
n. 2 clavettes en PA
n. 2 vis M8x25

Canal de PP con bordes de plástico
Rejillas de hierro dúctil
Kit de fijación
n.2 abrazaderas de PA
n. 2 tornillos M8x25

CODE	L x H	L1 x H1	kg	pack	€/m	€/m	€/m	€/m
517 1005 705BS	100 x 50	125 x 67	5,0	136	72,70	9,90	59,70	3,10
517 1010 705BS	100 x 100	125 x 117	5,5	72	75,80	13,00	59,70	3,10

CODE
17 352A

CODE
17 508A

CODE
17 705B



// Technical features

Do It Yourself

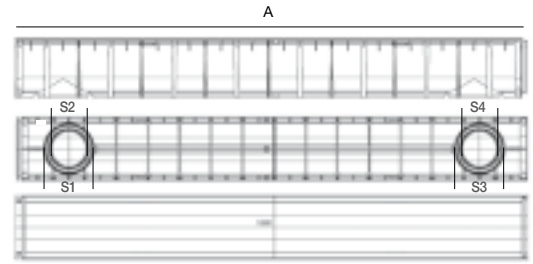
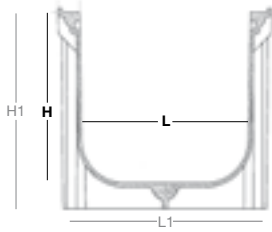

Canale PP con bordi in plastica

Plastic edged PP channel

Caniveau Brico en PP avec bordures plastique

Canal de PP con bordes de plástico

code	L	H	L1	H1	A	S1	S2	S3	S4	Kg/m	Pack	€/pc
517 1005	100	50	125	67	1000	90	75	100	80	0,8	128	9,90
517 1010	100	100	125	117	1000	90	75	100	80	1,2	80	13,00

dimensioni in mm - dimension in mm

CODE
17 352A

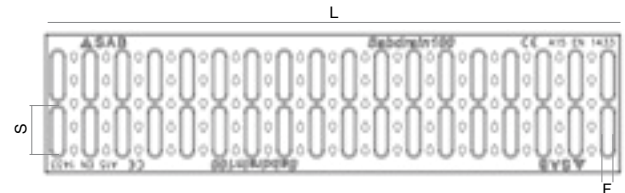
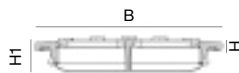

Griglie a fessura in PP

PP slotted grids

Grilles passerelles en PP

Rejillas ranuradas de PP

code	material	drain cm ²	B	H	H1	L	F	S	load class	Kg/m	Pack	€/pc
352A10	PP	144	118	8,4	21,4	500	9,5	42	A15	0,72	240	5,15

CODE
17 508A

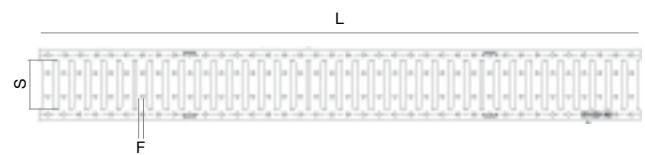
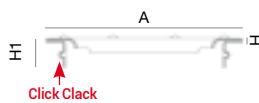

Griglia a fessura acciaio zincato

Galvanized steel slotted grid

Grille passerelle en acier galvanisé

Rejilla ranurada de acero galvanizado

code	material	drain cm ²	A	H	H1	L	F	S	load class	Kg/m	Pack	€/pc
508A10	steel	260	118	1,8	18,0	1000	7,5	82	A15	1,2	400	13,90

CODE
17 705B

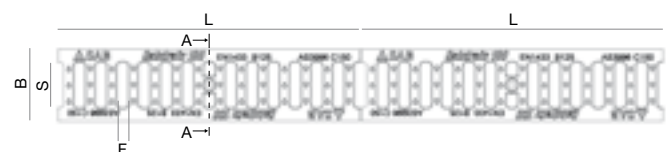
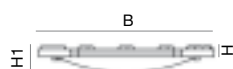

Griglia in ghisa sferoidale

Cast iron grid

Grille en fonte

Rejilla de hierro dúctil

code	material	drain cm ²	B	H	H1	L	F	S	load class	Kg/m	Pack	€/pc
705B10	cast iron - EN-GJS-500-7	348	118	7	17	495	18	74	B125	4,2	400	29,85



// Price list

Do It YourselfCODE
17 352A**SABdrainkit**

- n.3 Canali PP con bordi in plastica
- n.6 Griglie fessura in PP
- n.2 Paratie cieche

Plastic edged PP channels
PP slotted grids
Head plugs

Caniveaux en PP avec bordures plastique
Grilles passerelles en PP
Obturbateurs

Canales de PP con bordes de plástico
Rejillas ranuradas de PP
Tapones ciegos

CODE	L x H	L1 x H1	kg/kit	pcs	€/kit
517 1005 352AP K3A	100 x 50	125 x 67	4,5	72	67,60
517 1010 352AP K3A	100 x 100	125 x 117	5,7	42	76,90

CODE
17 508A**SABdrainkit**

- n.3 Canali PP con bordi in plastica
- n.3 Griglie a fessura acciaio zincato
- n.2 Paratie cieche

Plastic edged PP channels
Galvanized steel slotted grids
Head plugs

Caniveaux PP avec bordures plastique
Grilles passerelles en acier galvanisé
Obturbateurs

Canales de PP con bordes de plástico
Rejillas ranuradas de acero galvanizado
Tapones ciegos

CODE	L x H	L1 x H1	kg/kit	pcs	€/kit
517 1005 508AZ K3A	100 x 50	125 x 67	6,0	72	78,40
517 1010 508AZ K3A	100 x 100	125 x 117	7,2	42	87,70

CODE
17 705B**SABdrainkit**

- n.3 Canali PP con bordi in plastica
- n.6 Griglie in ghisa sferoidale
- n.3 Fissaggi
- n.2 staffe in PA / n.2 viti M8x25
- n.2 Paratie cieche

Plastic edged PP channels
Cast iron grids
Fix kits
n.2 PA clamps / n.2 screws M8x25
Head plugs

Caniveaux PP avec bordures plastique
Grilles en fonte
Kit de fixation
n. 2 clavettes en PA / n. 2 Vis 8x25
Obturbateurs

Canales de PP con bordes de plástico
Rejillas de hierro dúctil
Kit de fijación
n.2 abrazaderas de PA / n. 2 tornillos M8x25
Tapones ciegos

CODE	L x H	L1 x H1	kg/kit	pcs	€/kit
517 1005 705BS K3A	100 x 50	125 x 67	15,0	72	225,10
517 1010 705BS K3A	100 x 100	125 x 117	16,5	42	234,40

CODE
16 351AP



// Accessories

Do It Yourself

- n.1 Connettore a quattro vie per canale "fai da te"
- n.1 Griglia a fessura in PP

Croix multi-directionnelle pour caniveau Brico
Grille passerelle en PP

Four-way connector for "do it yourself" channel
PP slotted grid

Connector de cuatro vías para canales Brico
Rejilla ranurada de PP



CODE	L x H	kg	pack	€
516 1005 351AP	100 x 50	0,30	50	17,20
516 1010 351AP	100 x 100	0,35	25	19,80

CODE
16 508AZ



- n.1 Connettore a quattro vie per canale "fai da te"
- n.1 Griglia a fessura zincata

Croix multi-directionnelle pour caniveau Brico
Grille passerelle en acier galvanisé

Four-way connector for "do it yourself" channel
Galvanized slotted steel grid

Connector de cuatro vías para canales Brico
Rejilla ranurada acero galvanizado



CODE	L x H	kg	pack	€
516 1005 508AZ	100 x 50	0,32	50	18,30
516 1010 508AZ	100 x 100	0,40	25	20,90

CODE
16 705BS



- n.1 Connettore a quattro vie per canale "fai da te"
- n.1 Griglia in ghisa sferoidale

Croix multi-directionnelle pour caniveau Brico
Grille en fonte

Four-way connector for "do it yourself" channel
Cast iron grid

Connector de cuatro vías para canales Brico
Rejilla de hierro dúctil



CODE	L x H	kg	pack	€
516 1005 705BS	100 x 50	0,65	50	32,10
516 1010 705BS	100 x 100	0,75	25	34,90

Maggiore Enlarging piece Augmentation Aumentador de diámetro

CODE	Ø x Ø	kg	pack	€
5007 0000	90-100 x 110	0,05	5	1,98



Paratie cieche Blank end-plugs Obturateurs Tapones ciegos

CODE	Ø x Ø	kg	pack	€
5007 1005	100 x 50	0,03	10	4,09
5007 1010	100 x 100	0,06	10	5,57



CODE
10 351A



A15

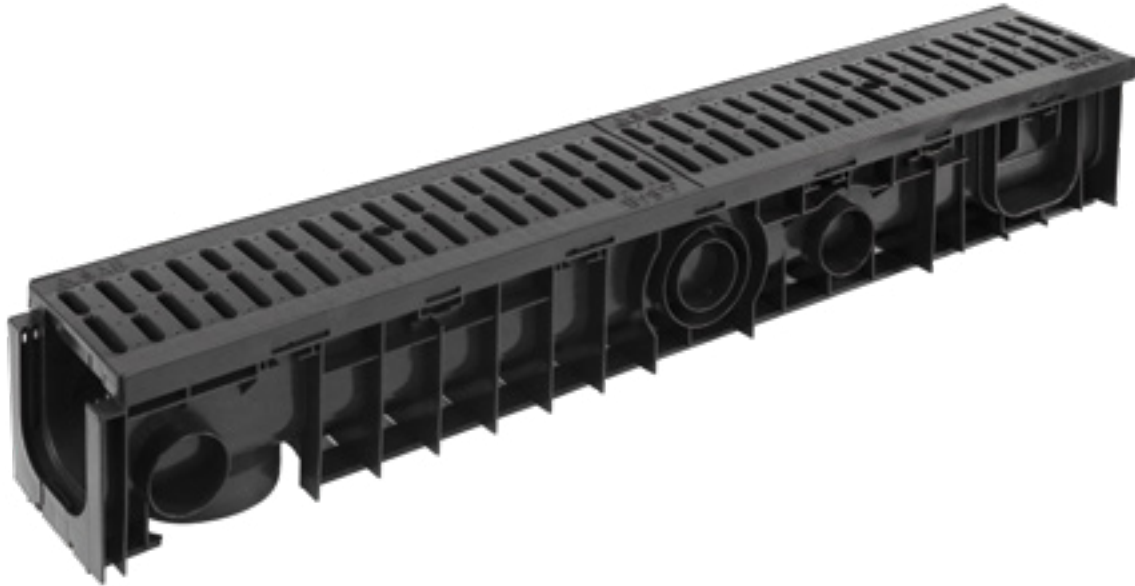

n.1 Canale PP con
bordi in plastica
n.2 Griglie a fessura in PP

Plastic edged
PP channel
PP slotted grids

Caniveau PP
bordure en plastique
Grilles passerelles en PP

Canal de PP con
bordes de plástico
Rejillas ranuradas de PP

CODE	L x H	L1 x H1	kg	pack	€/m	€/m	€/m
510 1005 351AP	100 x 50	150 x 100	3,0	70	29,06	18,50	10,56
510 1010 351AP	100 x 100	150 x 150	3,5	54	32,46	21,90	10,56
510 1015 351AP	100 x 150	150 x 200	4,0	45	37,16	26,60	10,56



CODE
10 351A



A15

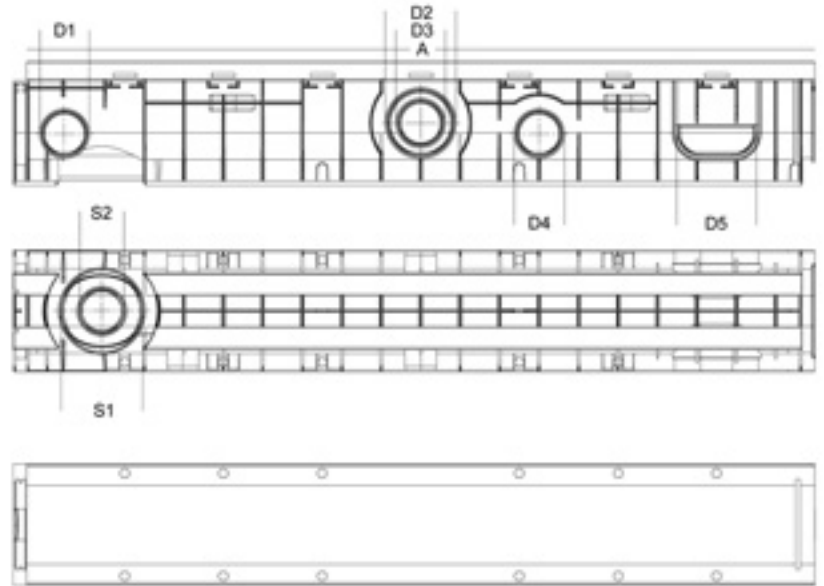
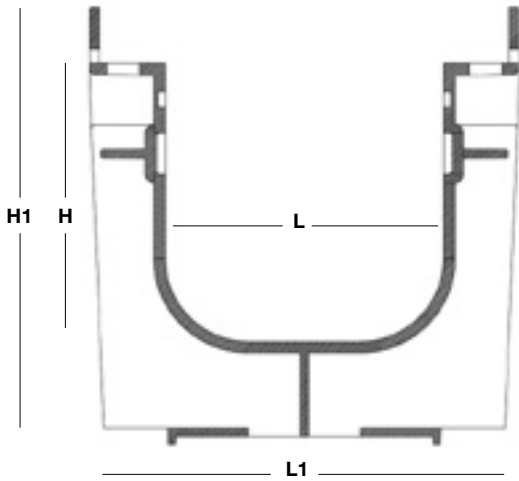

Canale PP con bordi in plastica

Plastic edged PP channel

Caniveau PP bordure en plastique

Canal de PP con bordes de plástico

code	L	H	L1	H1	A	D1	D2	D3	D4	D5	S1	S2	Kg	Pack	€
510 1005	100	50	152	106	1000	40	-	-	40	100	110	63	1,8	200	18,50
510 1010	100	100	152	157	1000	63	90	63	63	100	110	63	2,4	128	21,90
510 1015	100	150	152	210	1000	63	110	63	110	100	110	63	2,9	96	26,60

dimensioni in mm - dimension in mm

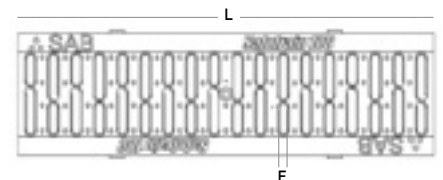
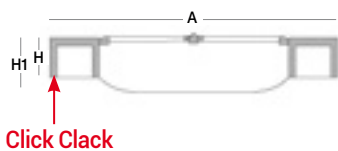

Griglia a fessura in PP

PP slotted grid

Grille passerelle en PP

Rejilla ranurada de PP

code	material	drain cm ²	A	H	H1	L	F	load class	Kg	Pack	€
351A10	PP	171	146	20	28	500	95 x 10	A15	0,6	240	5,28



CODE

10 355...

NEW

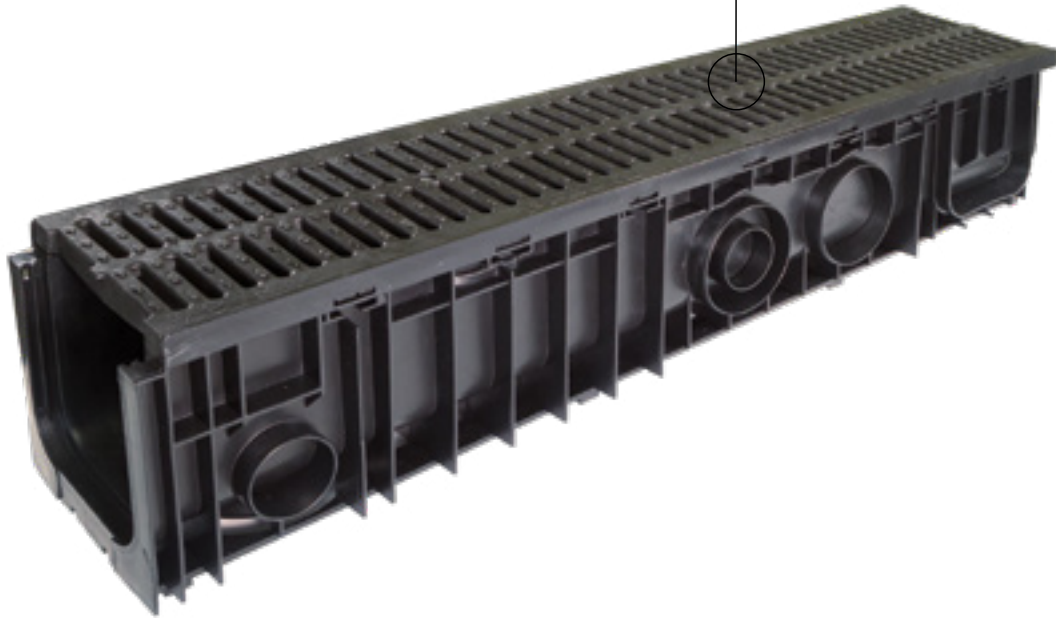
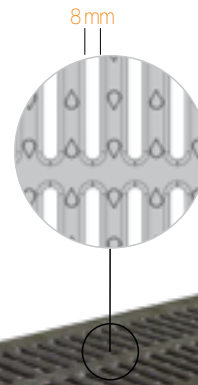

- n.1 Canale PP con bordi in plastica
- n.2 Griglie PAFV
- n.1 Fissaggio
- n.2 staffe zincate
- n. 2 viti 8x60

Plastic edged PP channel
PP channel
PAFV grids
Fix kit
n. 2 steel clamps
n. 2 screws 8x60

Caniveau PP bordure en plastique
Grilles en PAFV
Kit de fixation
n. 2 clavettes en acier
n. 2 vis 8x60

Canal de PP con bordes de plástico
Rejillas PAFV
Kit de fijación
n. 2 abrazaderas galvanizadas
n. 2 tornillos 8x60



CODE



L x H



L1 x H1



kg



pack



€/m



€/m



€/m



€/m

510 1005 355BP

100 x 50

150 x 100

4,1

70

81,30

18,50

59,70

3,10 *

510 1010 355BP

100 x 100

150 x 150

4,7

54

91,30

21,90

59,70

9,70

510 1015 355BP

100 x 150

150 x 200

5,2

45

96,00

26,60

59,70

9,70

510 1510 355BP

150 x 100

200 x 150

5,6

42

133,50

29,90

91,70

11,90

510 1515 355BP

150 x 150

200 x 200

6,3

30

138,60

35,00

91,70

11,90

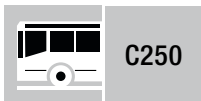

C250

510 1005 355CP

100 x 50

150 x 100

4,2

70

94,30

18,50

72,70

3,10 *

510 1010 355CP

100 x 100

150 x 150

4,8

54

104,30

21,90

72,70

9,70

510 1015 355CP

100 x 150

150 x 200

5,3

45

109,00

26,60

72,70

9,70

* staffe in plastica - plastic clamps



CODE
10 355...

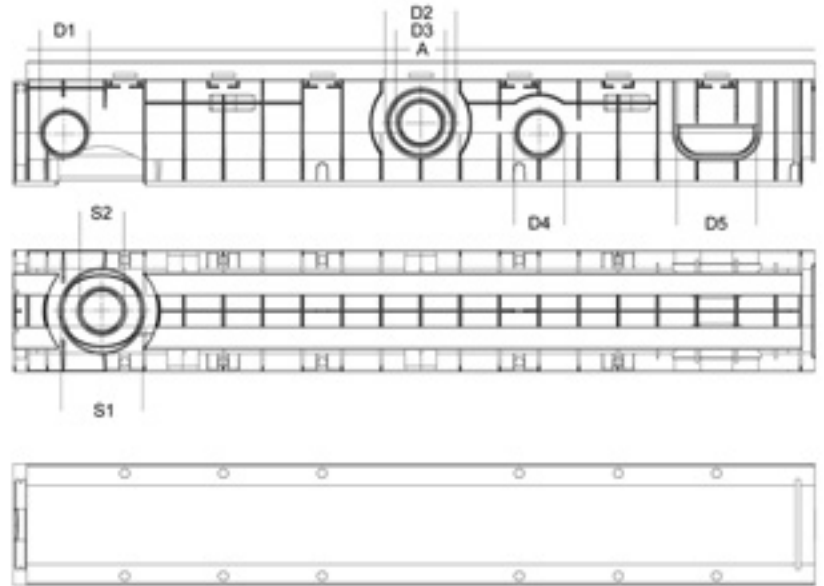
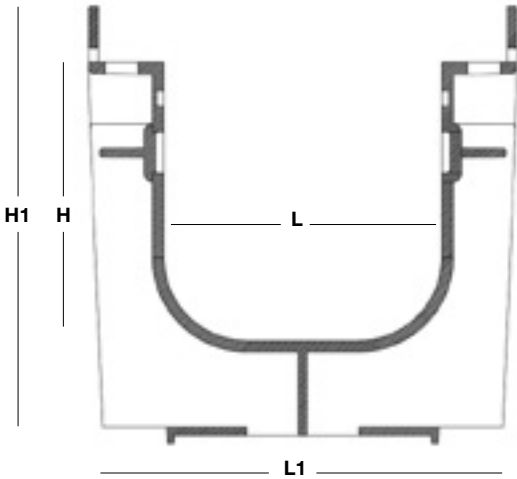

Canale PP con bordi in plastica

Plastic edged PP channel

Caniveau PP bordure en plastique

Canal de PP con bordes de plástico

code	L	H	L1	H1	A	D1	D2	D3	D4	D5	S1	S2	Kg	Pack	€
510 1005	100	50	152	106	1000	40	-	-	40	100	110	63	1,8	200	18,50
510 1010	100	100	152	157	1000	63	90	63	63	100	110	63	2,4	128	21,90
510 1015	100	150	152	210	1000	63	110	63	110	100	110	63	2,9	96	26,60
510 1510	150	100	200	160	1000	63	90	63	63	150	110	63	2,6	96	29,90
510 1515	150	150	200	210	1000	63	110	63	110	150	110	63	3,3	72	35,00

dimensioni in mm - dimension in mm

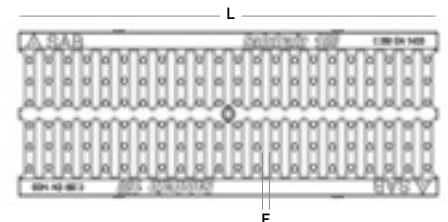
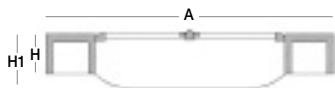

Griglia PAFV

PAGF grid

Grille en PAFV

Rejilla PAFV

code	material	drain cm ²	A	H	H1	L	F	load class	Kg	Pack	€
355B10	PA + GF	144	146	20	28	500	41 x 8	B125	1,0	240	29,85
355C10	PA + GF	144	146	20	28	500	41 x 8	C250	1,2	240	36,35
355B15	PA + GF	254	196	20	28	500	69 x 8	B125	1,5	180	45,85

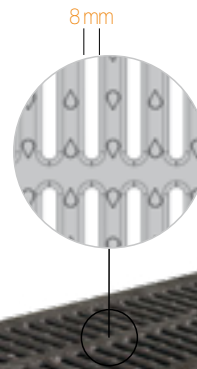
CODE
21 355...
NEW

n.1 Canale PP con bordi in acciaio
n.2 Griglie PAFV
n.1 Fissaggio
 n. 2 staffe zincate
 n. 2 viti 8x60

Steel edged PP channel
 PP channel
PAGF grids
 Fix kit
 n. 2 steel clamps
 n. 2 screws 8x60

Caniveau PP bordure en acier
 Grilles en **PAFV**
 Kit de fixation
 n. 2 clavettes en acier galvanisé
 n. 2 vis 8x60

Canal de PP con bordes de acero
 Rejillas **PAFV**
 Kit de fijación
 n.2 abrazaderas galvanizadas
 n.2 tornillos 8x60

B125	L x H	L1 x H1	kg	pack	€/m	€/m	€/m	€/m
521 1005 355BP	100 x 50	150 x 100	6,0	70	106,30	43,50	59,70	3,10 *
521 1010 355BP	100 x 100	150 x 150	6,8	54	116,30	46,90	59,70	9,70
521 1015 355BP	100 x 150	150 x 200	7,3	45	121,00	51,60	59,70	9,70
521 1510 355BP	150 x 100	200 x 150	8,4	42	158,60	55,00	91,70	11,90
521 1515 355BP	150 x 150	200 x 200	8,9	30	163,60	60,00	91,70	11,90

C250	L x H	L1 x H1	kg	pack	€/m	€/m	€/m	€/m
521 1005 355CP	100 x 50	150 x 100	6,1	70	119,30	43,50	72,70	3,10 *
521 1010 355CP	100 x 100	150 x 150	6,9	54	129,30	46,90	72,70	9,70
521 1015 355CP	100 x 150	150 x 200	7,4	45	134,00	51,60	72,70	9,70

* staffe in plastica - plastic clamps



back to index

// Technical features

CODE
21 355...

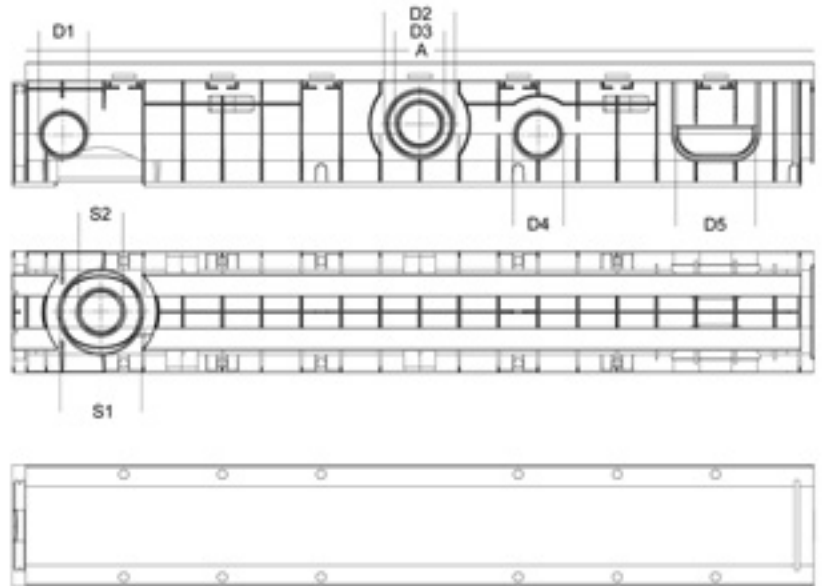
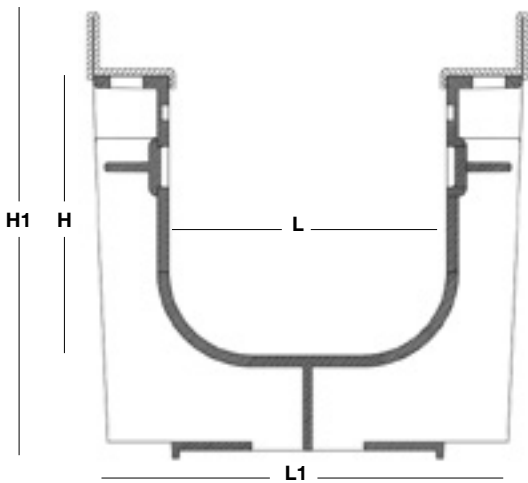

Canale PP con bordi in acciaio

Steel edged PP channel

Caniveau PP bordure en acier

Canal de PP con bordes de acero

code	L	H	L1	H1	A	D1	D2	D3	D4	D5	S1	S2	Kg	Pack	€
518 1005	100	50	152	112	1000	40	-	-	40	100	110	63	3,7	200	43,50
518 1010	100	100	152	162	1000	63	90	63	63	100	110	63	4,5	128	46,90
518 1015	100	150	152	212	1000	63	110	63	110	100	110	63	5,0	96	51,60
518 1510	150	100	200	167	1000	63	90	63	63	150	110	63	4,6	96	55,00
518 1515	150	150	200	212	1000	63	110	63	110	150	110	63	5,3	72	60,00

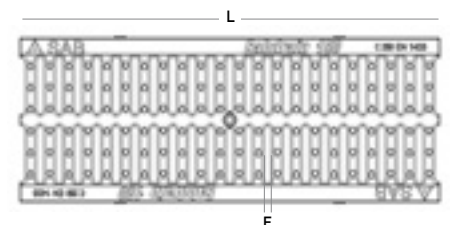
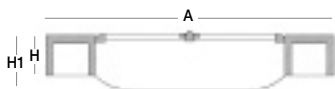

Griglia PAFV

PAGF grid

Grille en PAFV

Rejilla PAFV

code	material	drain cm ²	A	H	H1	L	F	load class	Kg	Pack	€
355B10	PA + GF	144	146	20	28	500	41 x 8	B125	1,1	240	29,85
355C10	PA + GF	144	146	20	28	500	41 x 8	C250	1,2	240	36,35
355B15	PA + GF	254	196	20	28	500	69 x 8	B125	1,5	180	45,85

CODE

10 501A



A15

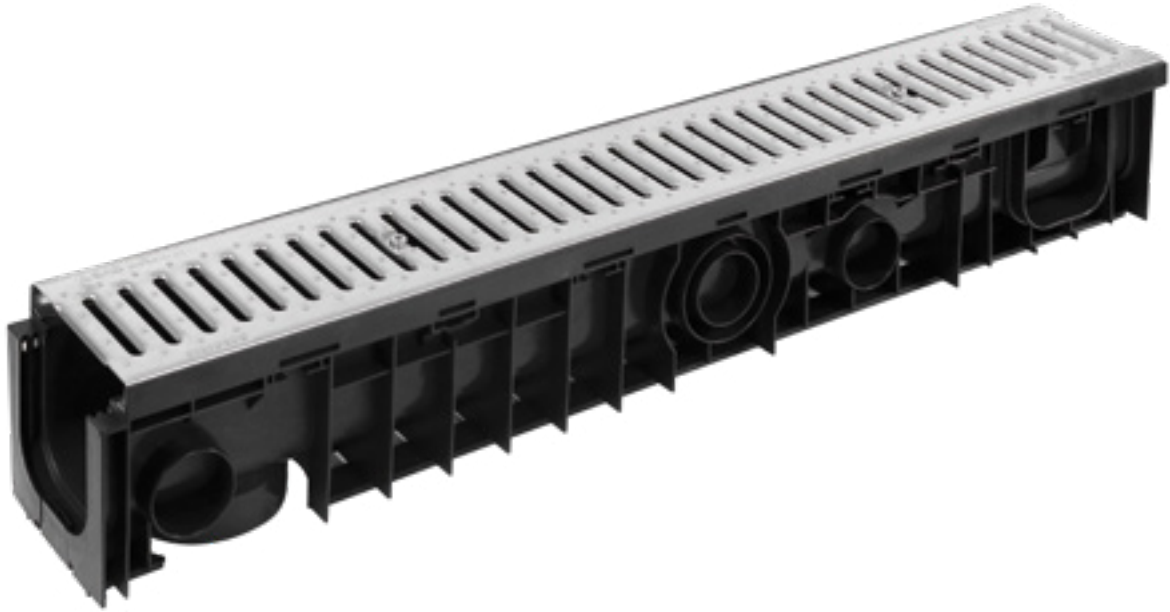









- n.1 Canale PP con bordi in plastica
- n.1 Griglia a fessura acciaio zincato
- n.1 Fissaggio
n.2 staffe zincate
n.2 viti 8x60

Plastic edged
PP channel
Galvanized
steel slotted grid
Fix kit
n. 2 steel clamps
n. 2 screws 8x60

Caniveau PP
bordure en plastique
Grille passerelle en acier
galvanisé
Kit de fixation
n. 2 clavettes en acier galvanisé
n. 2 vis 8x60

Canal de PP con
bordes de plástico
Rejilla ranurada de acero
galvanizado
Kit de fijación
n.2 abrazaderas galvanizadas
n.2 tornillos 8x60

CODE	 L x H	 L1 x H1	 kg	 pack	 €/m	 €/m	 €/m	 €/m
510 1005 501AZ	100 x 50	150 x 100	3,4	70	41,50	18,50	19,90	3,10*
510 1010 501AZ	100 x 100	150 x 150	4,1	54	44,90	21,90	19,90	3,10*
510 1015 501AZ	100 x 150	150 x 200	4,5	45	49,60	26,60	19,90	3,10*
510 1510 501AZ	150 x 100	200 x 150	5,5	42	71,70	29,90	29,90	11,90
510 1515 501AZ	150 x 150	200 x 200	6,2	30	76,80	35,00	29,90	11,90
510 2010 501AZ	200 x 100	250 x 150	7,4	35	90,50	34,10	42,00	14,40
510 2015 501AZ	200 x 150	250 x 200	7,9	25	93,40	37,00	42,00	14,40
510 2020 501AZ	200 x 200	250 x 250	8,4	20	97,70	41,30	42,00	14,40
510 2025 501AZ	200 x 250	250 x 300	8,9	15	100,50	44,10	42,00	14,40
510 2030 501AZ	200 x 300	250 x 350	9,4	15	103,40	47,00	42,00	14,40

* staffe in plastica - plastic clamps



CODE
10 501A



A15

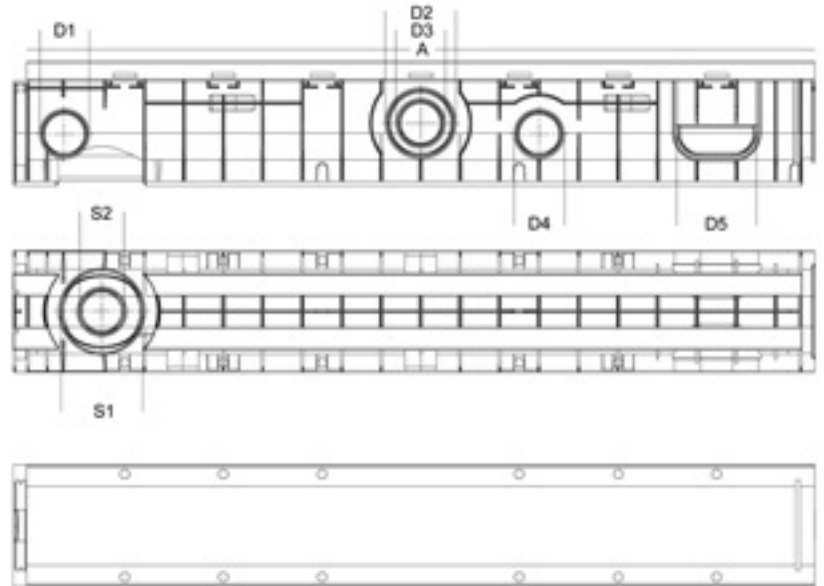
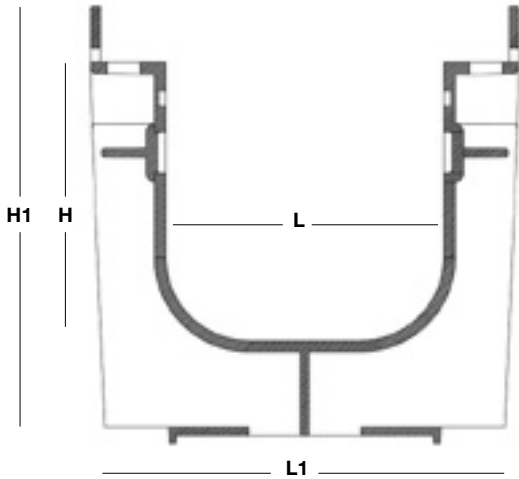

Canale PP con bordi in plastica

Plastic edged PP channel

Caniveau PP bordure en plastique

Canal de PP con bordes de plástico

code	L	H	L1	H1	A	D1	D2	D3	D4	D5	S1	S2	Kg	Pack	€
510 1005	100	50	152	106	1000	40	-	-	40	100	110	63	1,8	200	18,50
510 1010	100	100	152	157	1000	63	90	63	63	100	110	63	2,4	128	21,90
510 1015	100	150	152	210	1000	63	110	63	110	100	110	63	2,9	96	26,60
510 1510	150	100	200	160	1000	63	90	63	63	150	110	63	2,6	96	29,90
510 1515	150	150	200	210	1000	63	110	63	110	150	110	63	3,3	72	35,00
510 2010	200	100	255	158	1000	63	90	63	63	200	160	110	3,1	80	34,10
510 2015	200	150	255	210	1000	63	110	63	90	200	160	110	3,8	60	37,00
510 2020	200	200	255	260	1000	63	160	110	90	200	160	110	4,4	50	41,30
510 2025	200	250	255	310	1000	63	160	110	90	200	160	110	4,6	40	44,10
510 2030	200	300	255	360	1000	63	160	110	90	200	160	110	4,9	35	47,00

dimensioni in mm - dimension in mm

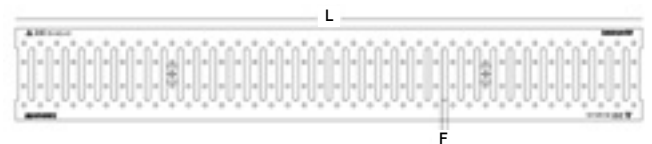
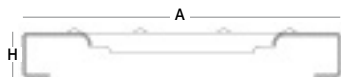

Griglia a fessura acciaio zincato

Galvanized steel slotted grid

Grille passerelle en acier galvanisé

Rejilla ranurada de acero galvanizado

code	material	drain cm ²	A	H	H1	L	F	load class	Kg	Pack	€
501A10	steel	260	145	20	-	1000	7,5 x 83	A15	1,6	400	19,90
501A15	steel	400	195	20	-	1000	8 x 130	A15	2,6	300	29,90
501A20	steel	400	245	20	-	1000	8 x 130	A15	3,9	200	42,00

CODE
10 601B

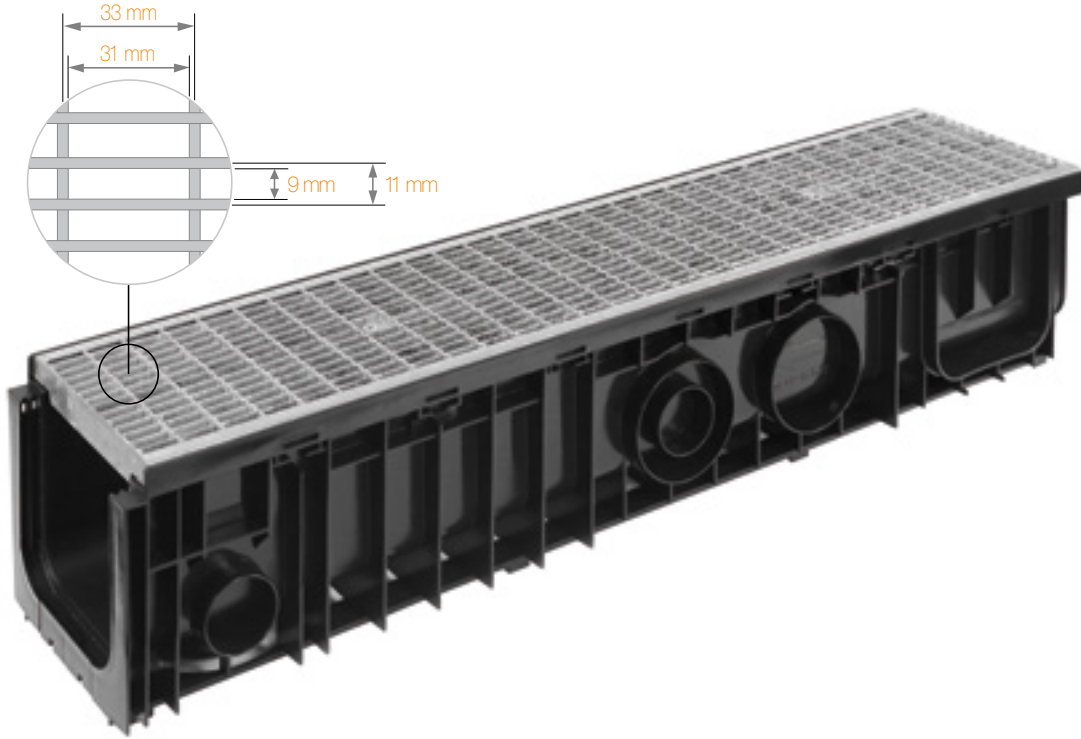

- n.1** Canale PP con bordi in plastica
- n.1** Griglia a maglia acciaio zincato
- n.1** Fissaggio
n. 2 staffe zincate
n. 2 viti 8x60

Plastic edged
PP channel
Galvanized
steel netted grid
Fix kit
n. 2 steel clamps
n. 2 screws 8x60

Caniveau PP
bordure en plastique
Grille caillebotis
en acier galvanisé
Kit de fixation
n. 2 clavettes en acier galvanisé
n. 2 vis 8x60

Canal de PP con
bordes de plástico
Rejilla de malla
de acero galvanizado
Kit de fijación
n.2 abrazaderas galvanizadas
n.2 tornillos 8x60

CODE	L x H	L1 x H1	kg	pack	€/m	€/m	€/m	€/m
510 1005 601BZ	100 x 50	150 x 100	5,7	70	78,70	18,50	57,10	3,10*
510 1010 601BZ	100 x 100	150 x 150	6,4	54	88,70	21,90	57,10	9,70
510 1015 601BZ	100 x 150	150 x 200	6,9	45	93,40	26,60	57,10	9,70
510 1510 601BZ	150 x 100	200 x 150	8,3	42	115,20	29,90	73,40	11,90
510 1515 601BZ	150 x 150	200 x 200	9,0	30	120,30	35,00	73,40	11,90
510 2010 601BZ	200 x 100	250 x 150	12,1	35	153,20	34,10	104,70	14,40
510 2015 601BZ	200 x 150	250 x 200	12,6	25	156,10	37,00	104,70	14,40
510 2020 601BZ	200 x 200	250 x 250	13,1	20	160,40	41,30	104,70	14,40
510 2025 601BZ	200 x 250	250 x 300	13,6	15	163,20	44,10	104,70	14,40
510 2030 601BZ	200 x 300	250 x 350	14,1	15	166,10	47,00	104,70	14,40

* staffe di plastica - plastic clamps



CODE
10 601B

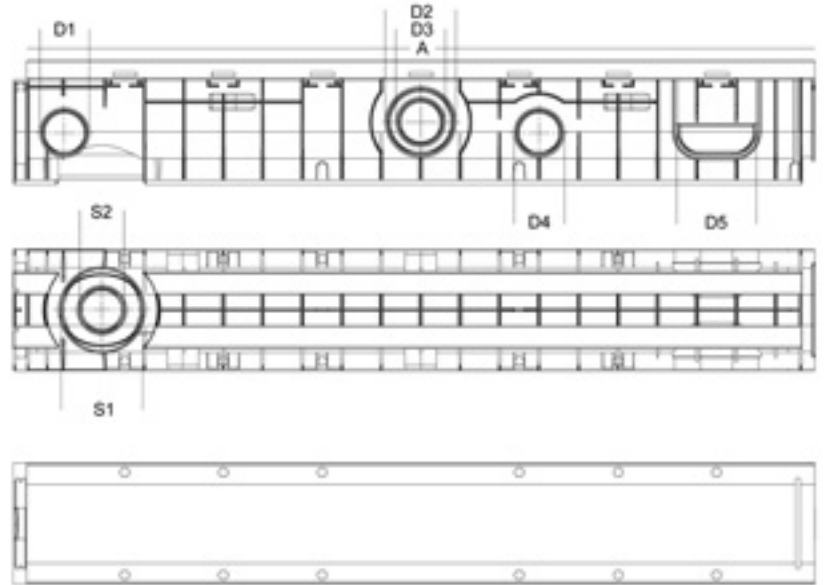
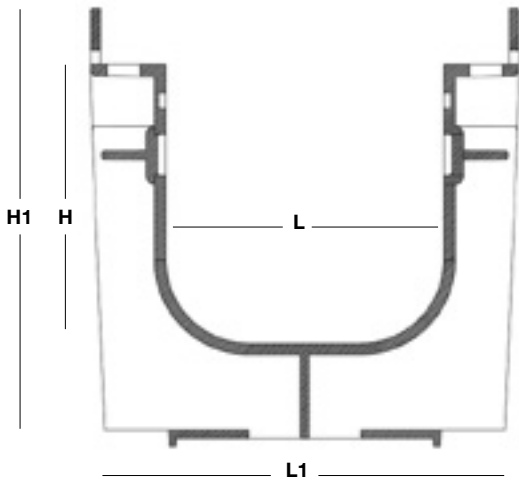
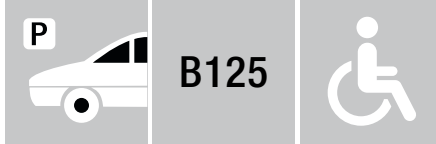

Canale PP con bordi in plastica

Plastic edged PP channel

Caniveau PP bordure en plastique

Canal de PP con bordes de plástico

code	L	H	L1	H1	A	D1	D2	D3	D4	D5	S1	S2	Kg	Pack	€
510 1005	100	50	152	106	1000	40	-	-	40	100	110	63	1,8	200	18,50
510 1010	100	100	152	157	1000	63	90	63	63	100	110	63	2,4	128	21,90
510 1015	100	150	152	210	1000	63	110	63	110	100	110	63	2,9	96	26,60
510 1510	150	100	200	160	1000	63	90	63	63	150	110	63	2,6	96	29,90
510 1515	150	150	200	210	1000	63	110	63	110	150	110	63	3,3	72	35,00
510 2010	200	100	255	158	1000	63	90	63	63	200	160	110	3,1	80	34,10
510 2015	200	150	255	210	1000	63	110	63	90	200	160	110	3,8	60	37,00
510 2020	200	200	255	260	1000	63	160	110	90	200	160	110	4,4	50	41,30
510 2025	200	250	255	310	1000	63	160	110	90	200	160	110	4,6	40	44,10
510 2030	200	300	255	360	1000	63	160	110	90	200	160	110	4,9	35	47,00

dimensioni in mm - dimension in mm

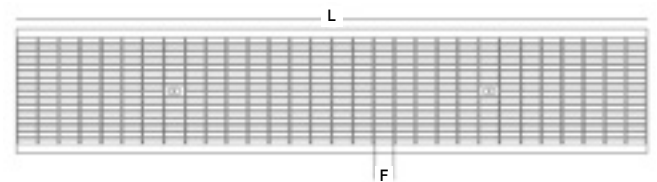
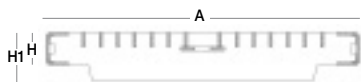

Griglia a maglia acciaio zincato

Galvanized steel netted grid

Grille caillebotis en acier galvanisé

Rejilla de malla de acero galvanizado

code	material	drain cm ²	A	H	H1	L	F	load class	Kg	Pack	€
601B10	steel	800	145	20	25	1000	31 x 9	B125	4,1	200	57,10
601B15	steel	1241	195	20	30	1000	31 x 9	B125	6,1	150	73,40
601B20	steel	1485	245	20	30	1000	31 x 9	B125	9,5	100	104,70

CODE
10 551B

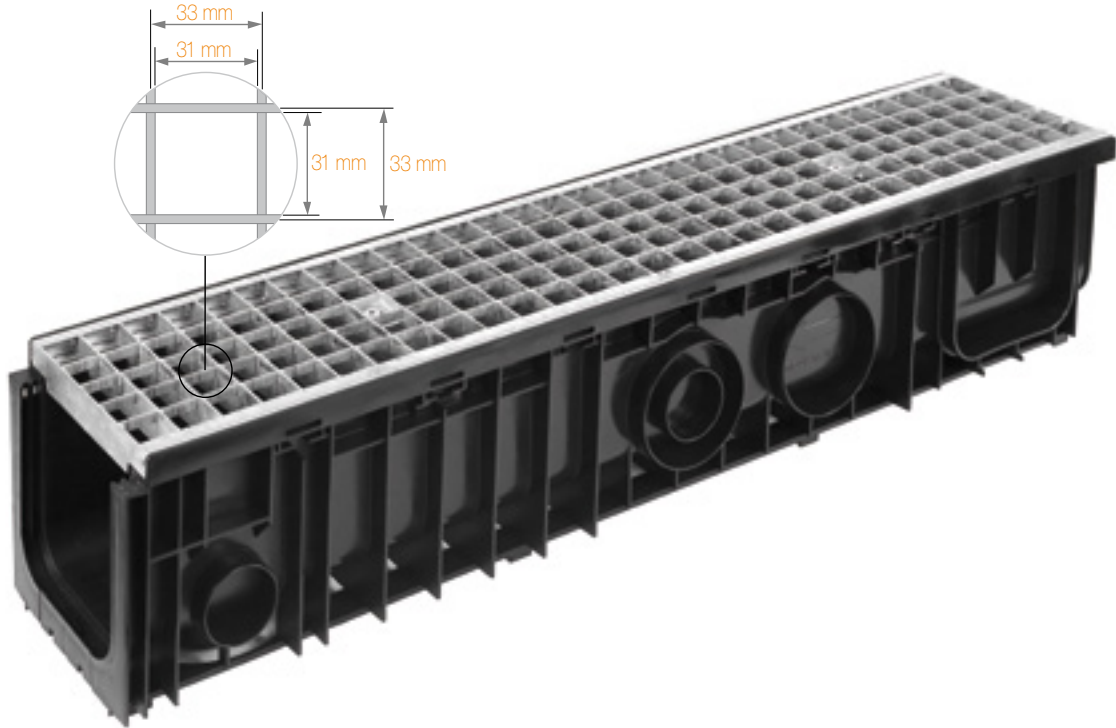

- n.1** Canale PP con bordi in plastica
- n.1** Griglia a maglia acciaio zincato
- n.1** Fissaggio
n. 2 staffe zincate
n. 2 viti 8x60

Plastic edged
PP channel
Galvanized
steel netted grid
Fix ki
n. 2 steel clamps
n. 2 screws 8x60

Caniveau PP
bordure en plastique
Grille caillebotis
en acier galvanisé
Kit de fixation
n. 2 clavettes en acier galvanisé
n. 2 vis 8x60

Canal de PP con
bordes de plástico
Rejilla de malla
de acero galvanizado
Kit de fijación
n.2 abrazaderas galvanizadas
n.2 tornillos 8x60

CODE	L x H	L1 x H1	kg	pack	€/m	€/m	€/m	€/m
510 1005 551BZ	100 x 50	150 x 100	5,1	70	69,90	18,50	48,30	3,10*
510 1010 551BZ	100 x 100	150 x 150	5,8	54	79,90	21,90	48,30	9,70
510 1015 551BZ	100 x 150	150 x 200	6,3	45	84,60	26,60	48,30	9,70
510 1510 551BZ	150 x 100	200 x 150	6,9	42	101,40	29,90	59,60	11,90
510 1515 551BZ	150 x 150	200 x 200	7,6	30	106,50	35,00	59,60	11,90
510 2010 551BZ	200 x 100	250 x 150	10,5	35	130,90	34,10	82,40	14,40
510 2015 551BZ	200 x 150	250 x 200	11,0	25	133,80	37,00	82,40	14,40
510 2020 551BZ	200 x 200	250 x 250	11,5	20	138,10	41,30	82,40	14,40
510 2025 551BZ	200 x 250	250 x 300	12,0	15	140,90	44,10	82,40	14,40
510 2030 551BZ	200 x 300	250 x 350	12,5	15	143,80	47,00	82,40	14,40

* staffe di plastica - plastic clamps

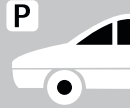
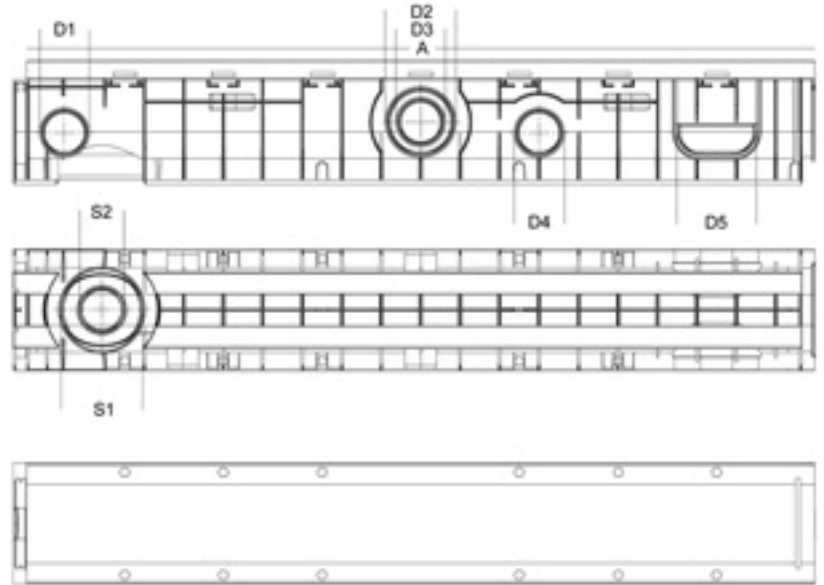
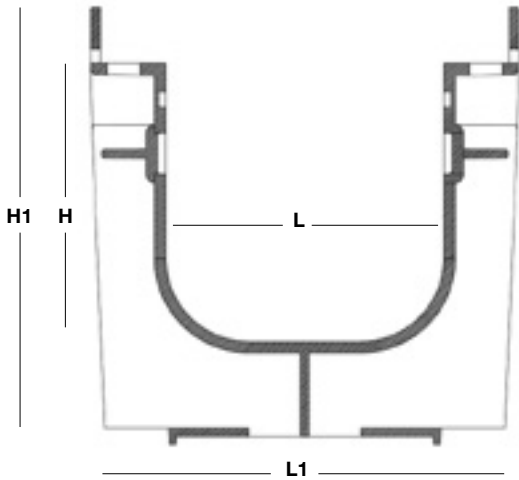
CODE
10 551B

B125

Canale PP con bordi in plastica
Plastic edged PP channel
Caniveau PP bordure en plastique
Canal de PP con bordes de plástico

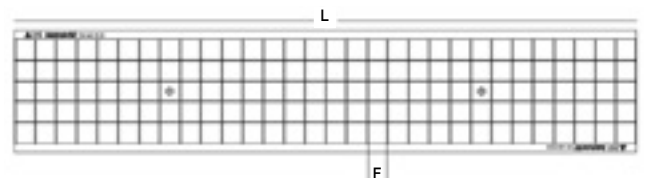
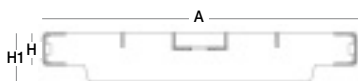
code	L	H	L1	H1	A	D1	D2	D3	D4	D5	S1	S2	Kg	Pack	€
510 1005	100	50	152	106	1000	40	-	-	40	100	110	63	1,8	200	18,50
510 1010	100	100	152	157	1000	63	90	63	63	100	110	63	2,4	128	21,90
510 1015	100	150	152	210	1000	63	110	63	110	100	110	63	2,9	96	26,60
510 1510	150	100	200	160	1000	63	90	63	63	150	110	63	2,6	96	29,90
510 1515	150	150	200	210	1000	63	110	63	110	150	110	63	3,3	72	35,00
510 2010	200	100	255	158	1000	63	90	63	63	200	160	110	3,1	80	34,10
510 2015	200	150	255	210	1000	63	110	63	90	200	160	110	3,8	60	37,00
510 2020	200	200	255	260	1000	63	160	110	90	200	160	110	4,4	50	41,30
510 2025	200	250	255	310	1000	63	160	110	90	200	160	110	4,6	40	44,10
510 2030	200	300	255	360	1000	63	160	110	90	200	160	110	4,9	35	47,00

dimensioni in mm - dimension in mm

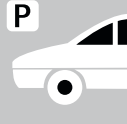
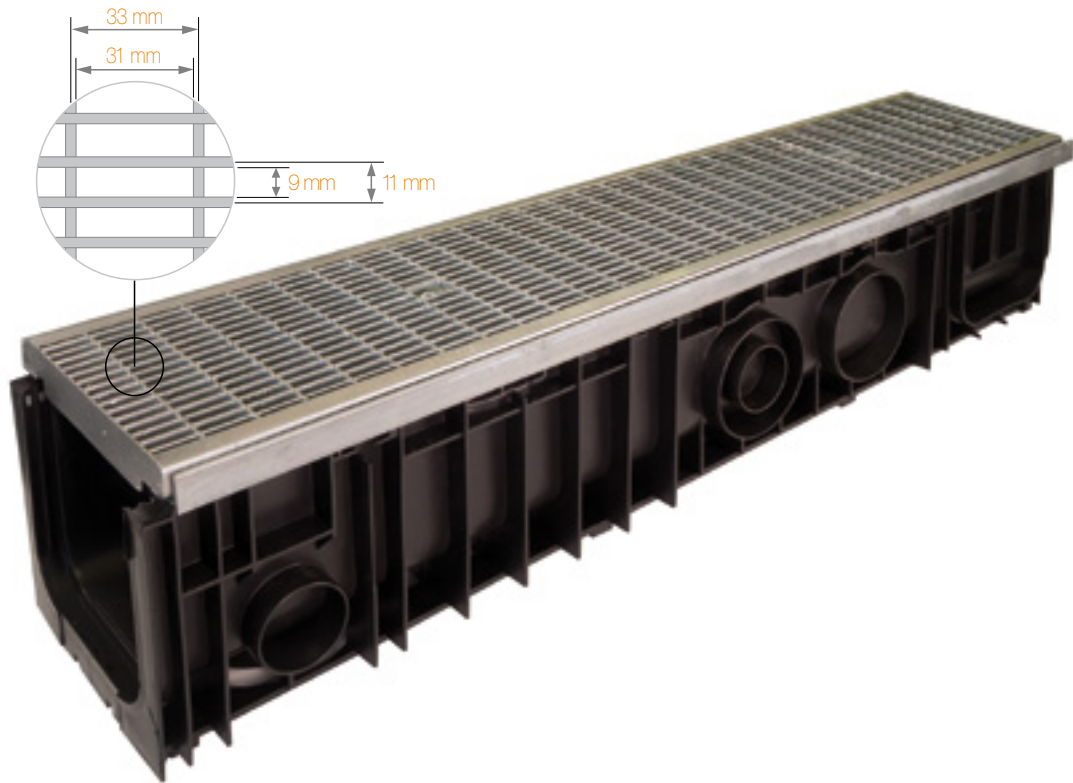
Griglia a maglia acciaio zincato
Galvanized steel netted grid
Grille caillebotis en acier galvanisé
Rejilla de malla de acero galvanizado

code	material	drain cm ²	A	H	H1	L	F	load class	Kg	Pack	€
551B10	steel	1019	145	20	30	1000	31 x 31	B125	3,5	200	48,30
551B15	steel	1487	195	20	30	1000	31 x 31	B125	4,3	200	59,60
551B20	steel	1782	245	20	30	1000	31 x 31	B125	6,8	100	82,40

CODE
21 601B
P

B125

- n.1 Canale PP con bordi in acciaio**
- n.1 Griglia a maglia acciaio zincato**
- n.1 Fissaggio**
n.2 staffe zincate
n.2 viti 8x60

Steel edged
PP channel
Galvanized
steel netted grid
Fix kit
n.2 steel clamps
n.2 screws 8x60

Caniveau PP
bordure en acier
Grille caillebotis
en acier galvanisé
Kit de fixation
n. 2 clavettes en acier galvanisé
n. 2 vis 8x60

Canal de PP
con bordes de acero
Rejilla de malla
de acero galvanizado
Kit de fijación
n.2 abrazaderas galvanizadas
n.2 tornillos 8x60

CODE	L x H	L1 x H1	kg	pack	€/m	€/m	€/m	€/m
521 1005 601BZ	100 x 50	150 x 100	7,8	70	103,70	43,50	57,10	3,10*
521 1010 601BZ	100 x 100	150 x 150	8,4	54	113,70	46,90	57,10	9,70
521 1015 601BZ	100 x 150	150 x 200	8,9	45	118,40	51,60	57,10	9,70
521 1510 601BZ	150 x 100	200 x 150	10,3	42	140,30	55,00	73,40	11,90
521 1515 601BZ	150 x 150	200 x 200	11,0	30	145,30	60,00	73,40	11,90
521 2010 601BZ	200 x 100	250 x 150	14,1	35	178,30	59,20	104,70	14,40
521 2015 601BZ	200 x 150	250 x 200	14,6	25	181,10	62,00	104,70	14,40
521 2020 601BZ	200 x 200	250 x 250	15,1	20	185,40	66,30	104,70	14,40
521 2025 601BZ	200 x 250	250 x 300	15,6	15	188,30	69,20	104,70	14,40
521 2030 601BZ	200 x 300	250 x 350	16,1	15	191,10	72,00	104,70	14,40

* staffe di plastica - plastic clamps



CODE
21 601B

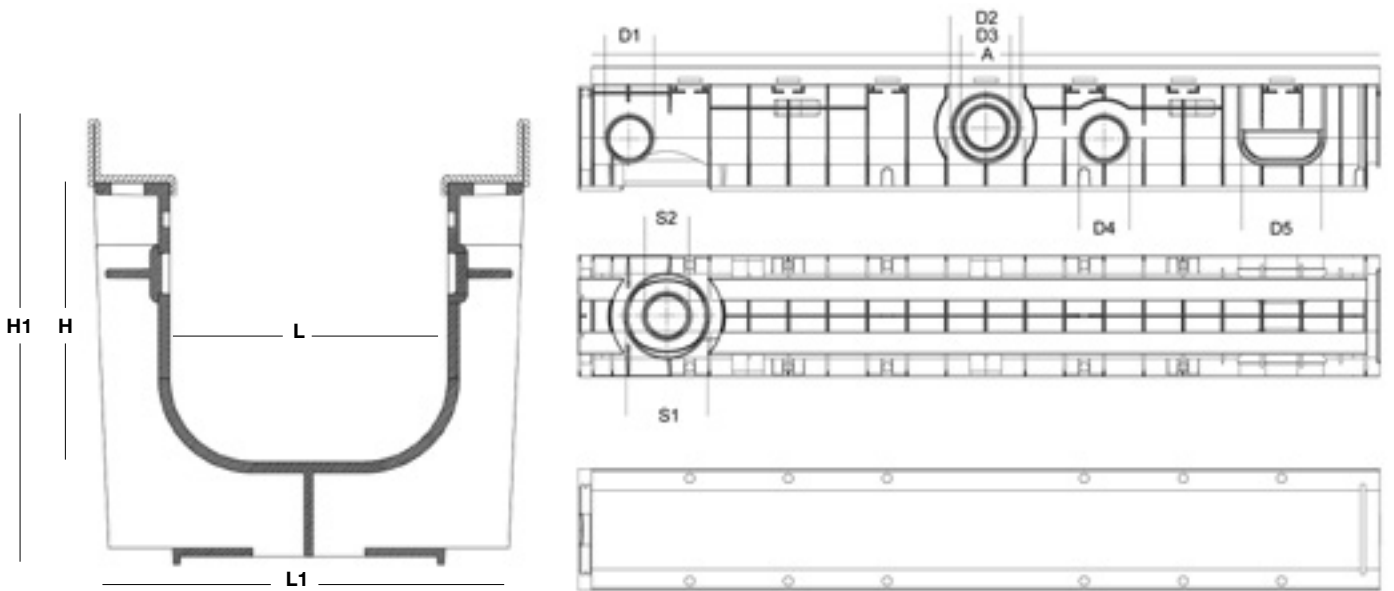
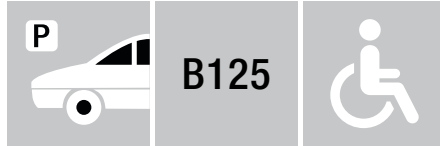

Canale PP con bordi in acciaio

Steel edged PP channel

Caniveau PP bordure en acier

Canal de PP con bordes de acero

code	L	H	L1	H1	A	D1	D2	D3	D4	D5	S1	S2	Kg	Pack	€
518 1005	100	50	152	112	1000	40	-	-	40	100	110	63	3,7	200	43,50
518 1010	100	100	152	162	1000	63	90	63	63	100	110	63	4,5	128	46,90
518 1015	100	150	152	212	1000	63	110	63	110	100	110	63	5,0	96	51,60
518 1510	150	100	200	167	1000	63	90	63	63	150	110	63	4,6	96	55,00
518 1515	150	150	200	212	1000	63	110	63	110	150	110	63	5,3	72	60,00
518 2010	200	100	255	162	1000	63	90	63	63	200	160	110	5,1	80	59,20
518 2015	200	150	255	212	1000	63	110	63	90	200	160	110	5,6	60	62,00
518 2020	200	200	255	262	1000	63	160	110	90	200	160	110	6,7	50	66,30
518 2025	200	250	255	312	1000	63	160	110	90	200	160	110	6,8	40	69,20
518 2030	200	300	255	362	1000	63	160	110	90	200	160	110	7,3	35	72,00

dimensioni in mm - dimension in mm

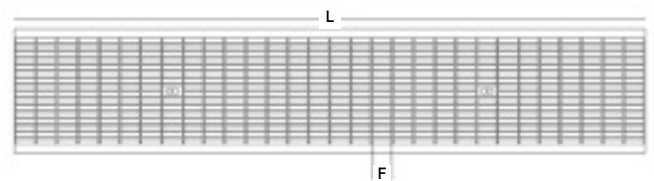

Griglia a maglia acciaio zincato

Galvanized steel netted grid

Grille caillebotis en acier galvanisé

Rejilla de malla de acero galvanizado

code	material	drain cm ²	A	H	H1	L	F	load class	Kg	Pack	€
601B10	steel	800	145	20	25	1000	31 x 9	B125	4,1	200	57,10
601B15	steel	1241	195	20	30	1000	31 x 9	B125	6,1	150	73,40
601B20	steel	1485	245	20	30	1000	31 x 9	B125	9,5	100	104,70

CODE
21 551B
P

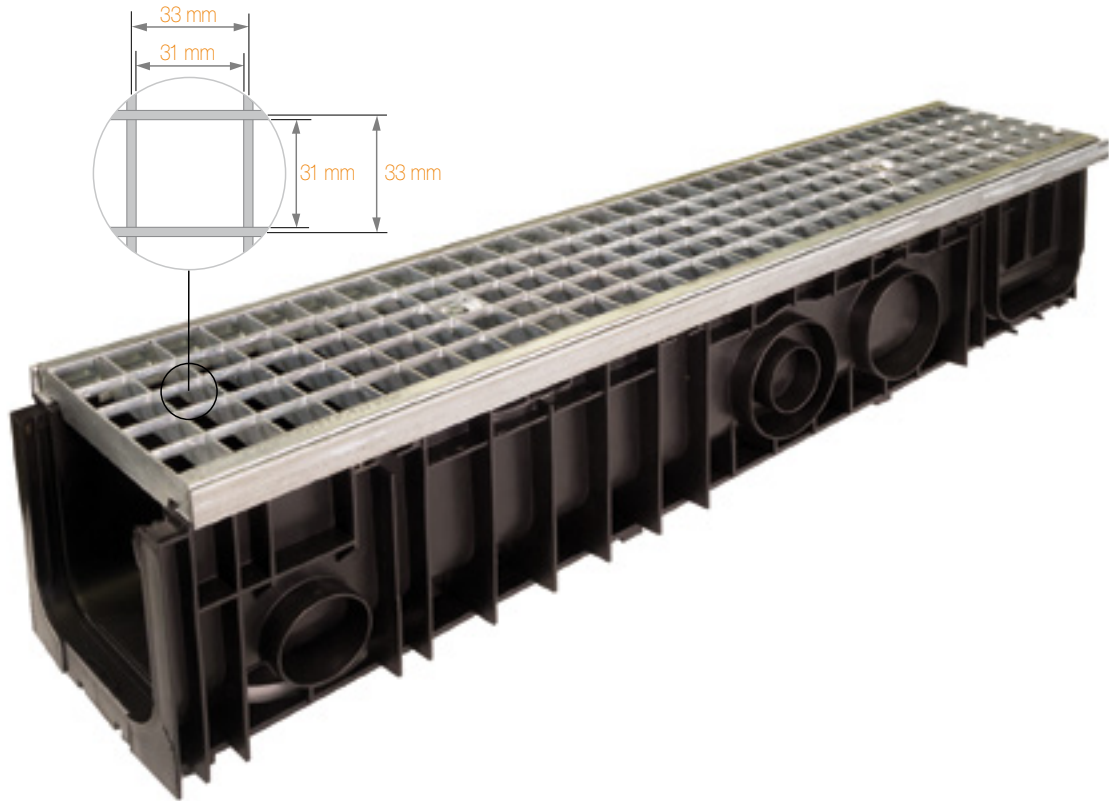
B125

- n.1** Canale PP con bordi in acciaio
- n.1** Griglia a maglia acciaio zincato
- n.1** Fissaggio
n.2 staffe zincate
n.2 viti 8x60

Steel edged
PP channel
Galvanized
steel netted grid
Fix kit
n.2 steel clamps
n.2 screws 8x60

Caniveau PP
bordure en acier
Grille caillebotis
en acier galvanisé
Kit de fixation
n. 2 clavettes en acier galvanisé
n. 2 vis 8x60

Canal de PP con
bordes de acero
Rejilla de malla
de acero galvanizado
Kit de fijación
n.2 abrazaderas galvanizadas
n.2 tornillos 8x60

CODE	L x H	L1 x H1	kg	pack	€/m	€/m	€/m	€/m
521 1005 551BZ	100 x 50	150 x 100	7,2	70	94,90	43,50	48,30	3,10*
521 1010 551BZ	100 x 100	150 x 150	7,8	54	104,90	46,90	48,30	9,70
521 1015 551BZ	100 x 150	150 x 200	8,3	45	109,60	51,60	48,30	9,70
521 1510 551BZ	150 x 100	200 x 150	8,9	42	126,50	55,00	59,60	11,90
521 1515 551BZ	150 x 150	200 x 200	9,6	30	131,50	60,00	59,60	11,90
521 2010 551BZ	200 x 100	250 x 150	12,5	35	156,00	59,20	82,40	14,40
521 2015 551BZ	200 x 150	250 x 200	13,0	25	158,80	62,00	82,40	14,40
521 2020 551BZ	200 x 200	250 x 250	13,5	20	163,10	66,30	82,40	14,40
521 2025 551BZ	200 x 250	250 x 300	14,0	15	166,00	69,20	82,40	14,40
521 2030 551BZ	200 x 300	250 x 350	14,5	15	168,80	72,00	82,40	14,40

* staffe in plastica - plastic clamps



CODE
21 551B

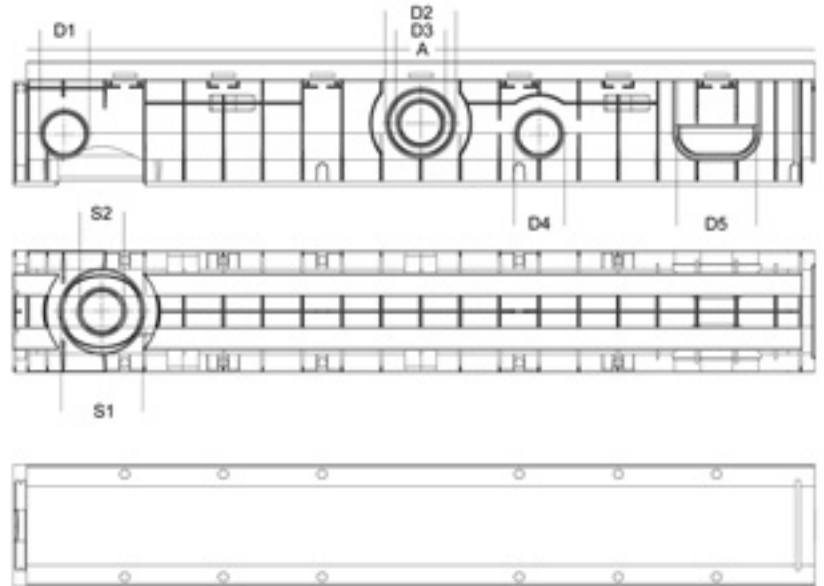
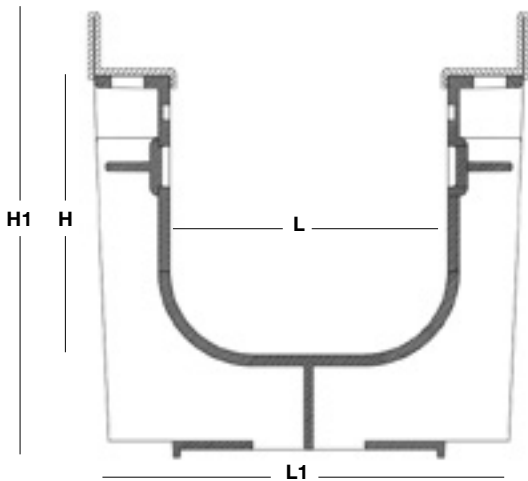

Canale PP con bordi in acciaio

Steel edged PP channel

Caniveau PP bordure en acier

Canal de PP con bordes de acero

code	L	H	L1	H1	A	D1	D2	D3	D4	D5	S1	S2	Kg	Pack	€
518 1005	100	50	152	112	1000	40	-	-	40	100	110	63	3,7	200	43,50
518 1010	100	100	152	162	1000	63	90	63	63	100	110	63	4,5	128	46,90
518 1015	100	150	152	212	1000	63	110	63	110	100	110	63	5,0	96	51,60
518 1510	150	100	200	167	1000	63	90	63	63	150	110	63	4,6	96	55,00
518 1515	150	150	200	212	1000	63	110	63	110	150	110	63	5,3	72	60,00
518 2010	200	100	255	162	1000	63	90	63	63	200	160	110	5,1	80	59,20
518 2015	200	150	255	212	1000	63	110	63	90	200	160	110	5,6	60	62,00
518 2020	200	200	255	262	1000	63	160	110	90	200	160	110	6,7	50	66,30
518 2025	200	250	255	312	1000	63	160	110	90	200	160	110	6,8	40	69,20
518 2030	200	300	255	362	1000	63	160	110	90	200	160	110	7,3	35	72,00

dimensioni in mm - dimension in mm

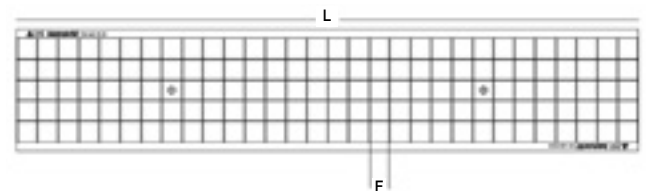
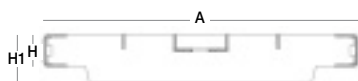

Griglia a maglia acciaio zincato

Galvanized steel netted grid

Grille caillebotis en acier galvanisé

Rejilla de malla de acero galvanizado

code	material	drain cm ²	A	H	H1	L	F	load class	Kg	Pack	€
551B10	steel	1019	145	20	30	1000	31 x 31	B125	3,5	200	48,30
551B15	steel	1487	195	20	30	1000	31 x 31	B125	4,3	200	59,60
551B20	steel	1782	245	20	30	1000	31 x 31	B125	6,8	100	82,40

CODE
10 704C

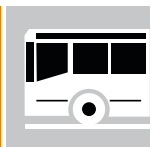

C250



- n.1 Canale PP con bordi in plastica
- n.2 Griglie in ghisa sferoidale
- n.1 Fissaggio
n.8 viti M10x25
n.8 piastrini

Plastic edged
PP channel
Cast iron grids

Fix kit
n.8 screws M10x25
n.8 threaded plates

Caniveau PP
bordure en plastique
Grilles en fonte

kit de fixation
n.8 vis M10x25
n. 8 plaques filetées

Canal de PP con bordes de plástico
Rejillas de hierro dúctil

Kit de fijación
n.8 tornillos M10x25
n.8 chapetas

CODE	 L x H	 L1 x H1	 kg	 pack	 €/m	€/m	€/m	€/m
510 1005 704CS	100 x 50	150 x 100	10,7	70	123,10	18,50	96,20	8,40
510 1010 704CS	100 x 100	150 x 150	11,3	54	126,50	21,90	96,20	8,40
510 1015 704CS	100 x 150	150 x 200	11,8	45	131,20	26,60	96,20	8,40
510 1510 704CS	150 x 100	200 x 150	14,5	42	157,70	29,90	119,40	8,40
510 1515 704CS	150 x 150	200 x 200	15,2	30	162,80	35,00	119,40	8,40
510 2005 704CS	200 x 50	250 x 100	16,9	40	201,10	31,30	161,40	8,40
510 2010 704CS	200 x 100	250 x 150	17,4	35	203,90	34,10	161,40	8,40
510 2015 704CS	200 x 150	250 x 200	17,9	25	206,80	37,00	161,40	8,40
510 2020 704CS	200 x 200	250 x 250	18,4	20	211,10	41,30	161,40	8,40
510 2025 704CS	200 x 250	250 x 300	18,9	15	213,90	44,10	161,40	8,40
510 2030 704CS	200 x 300	250 x 350	19,4	15	216,80	47,00	161,40	8,40



CODE
10 704C

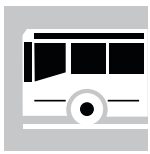

C250

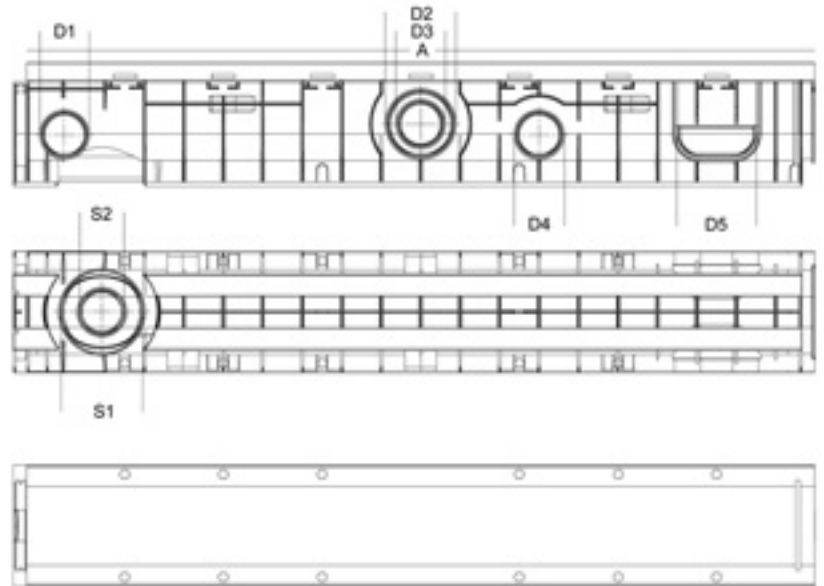
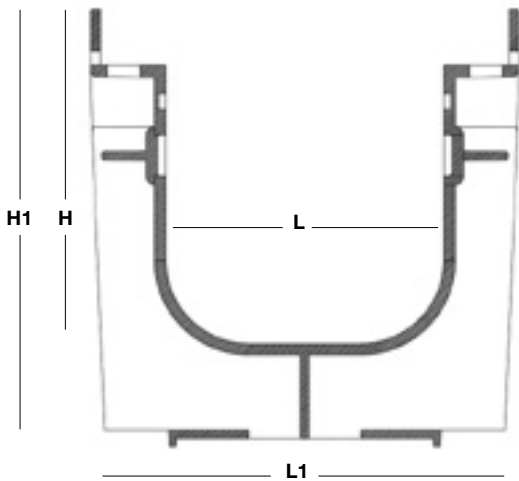

Canale PP con bordi in plastica

Plastic edged PP channel

Caniveau PP bordure en plastique

Canal de PP con bordes de plástico

code	L	H	L1	H1	A	D1	D2	D3	D4	D5	S1	S2	Kg	Pack	€
510 1005	100	50	152	106	1000	40	-	-	40	100	110	63	1,8	200	18,50
510 1010	100	100	152	157	1000	63	90	63	63	100	110	63	2,4	128	21,90
510 1015	100	150	152	210	1000	63	110	63	110	100	110	63	2,9	96	26,60
510 1510	150	100	200	160	1000	63	90	63	63	150	110	63	2,6	96	29,90
510 1515	150	150	200	210	1000	63	110	63	110	150	110	63	3,3	72	35,00
510 2005	200	50	255	106	1000	40	-	-	40	200	160	110	2,6	125	31,30
510 2010	200	100	255	158	1000	63	90	63	63	200	160	110	3,1	80	34,10
510 2015	200	150	255	210	1000	63	110	63	90	200	160	110	3,8	60	37,00
510 2020	200	200	255	260	1000	63	160	110	90	200	160	110	4,4	50	41,30
510 2025	200	250	255	310	1000	63	160	110	90	200	160	110	4,6	40	44,10
510 2030	200	300	255	360	1000	63	160	110	90	200	160	110	4,9	35	47,00

dimensioni in mm - dimension in mm

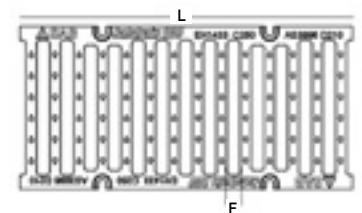

Griglia in ghisa sferoidale

Cast iron grid

Grille en fonte

Rejilla de hierro dúctil

code	material	drain cm ²	A	H	H1	L	F	load class	Kg	Pack	€
704C10	cast iron - EN-GJS-500-7	220	146	20	20	500	86 x 16	C250	4,3	400	48,10
704C15	cast iron - EN-GJS-500-7	348	197	20	20	500	136 x 16	C250	5,8	280	59,70
704C20	cast iron - EN-GJS-500-7	494	247	20	40	500	186 x 18	C250	6,8	120	80,70

CODE
25 704C

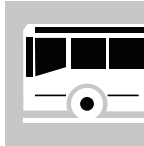

C250



n.1 Canale PP con bordi in acciaio
n.2 Griglie in ghisa sferoidale
n.1 Fissaggio
n.8 zanche M10
n.8 viti M10x25

Steel edged
PP channel
Cast iron grids

Fix kit
n.8 anchors M10
n.8 screws M10x25

Caniveau PP
bordure en acier
Grilles en fonte

Kit de fixation
n. 8 pattes d'ancrage M10
n. 8 vis M10x25

Canal de PP con bordes de acero
Rejillas de hierro dúctil
Kit de fijación
n.8 anclajes M10
n.8 tornillos M10x25

CODE	 L x H	 L1 x H1	 kg	 pack	 €/m	 €/m	 €/m	 €/m
525 1005 704CS	100 x 50	150 x 100	13,0	70	155,30	43,50	96,20	15,60
525 1010 704CS	100 x 100	150 x 150	13,6	54	158,70	46,90	96,20	15,60
525 1015 704CS	100 x 150	150 x 200	14,1	45	163,40	51,60	96,20	15,60
525 1510 704CS	150 x 100	200 x 150	16,8	42	190,00	55,00	119,40	15,60
525 1515 704CS	150 x 150	200 x 200	17,5	30	195,00	60,00	119,40	15,60
525 2005 704CS	200 x 50	250 x 100	19,2	40	233,30	56,30	161,40	15,60
525 2010 704CS	200 x 100	250 x 150	19,7	35	236,20	59,20	161,40	15,60
525 2015 704CS	200 x 150	250 x 200	20,2	25	239,00	62,00	161,40	15,60
525 2020 704CS	200 x 200	250 x 250	20,7	20	243,30	66,30	161,40	15,60
525 2025 704CS	200 x 250	250 x 300	21,2	15	246,20	69,20	161,40	15,60
525 2030 704CS	200 x 300	250 x 350	21,7	15	249,00	72,00	161,40	15,60



CODE
25 704C

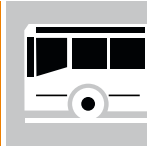

C250

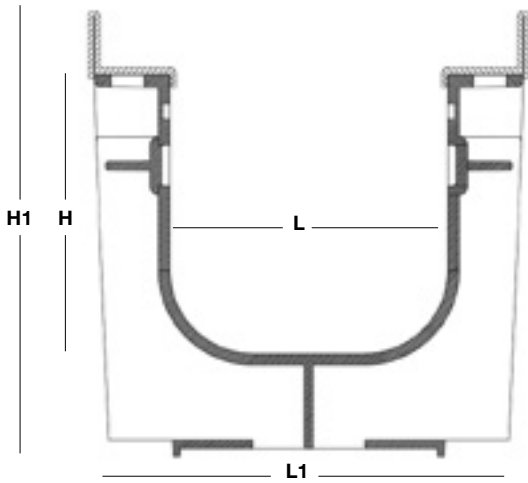

Canale PP con bordi in acciaio

Steel edged PP channel

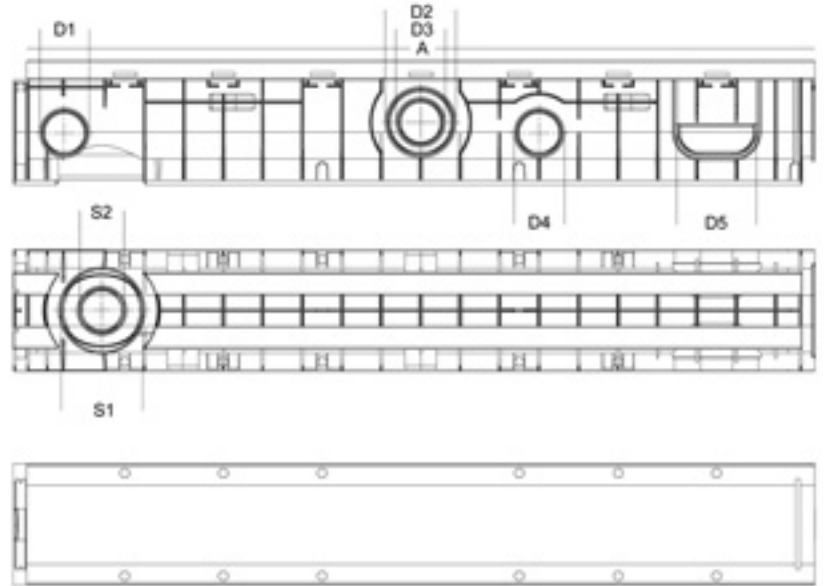

Caniveau PP bordure en acier

Canal de PP con bordes de acero

code	L	H	L1	H1	A	D1	D2	D3	D4	D5	S1	S2	Kg	Pack	€
518 1005	100	50	152	112	1000	40	-	-	40	100	110	63	3,7	200	43,50
518 1010	100	100	152	162	1000	63	90	63	63	100	110	63	4,5	128	46,90
518 1015	100	150	152	212	1000	63	110	63	110	100	110	63	5,0	96	51,60
518 1510	150	100	200	167	1000	63	90	63	63	150	110	63	4,6	96	55,00
518 1515	150	150	200	212	1000	63	110	63	110	150	110	63	5,3	72	60,00
518 2005	200	50	255	106	1000	40	-	-	40	200	160	110	4,6	125	56,30
518 2010	200	100	255	162	1000	63	90	63	63	200	160	110	5,1	80	59,20
518 2015	200	150	255	212	1000	63	110	63	90	200	160	110	5,6	60	62,00
518 2020	200	200	255	262	1000	63	160	110	90	200	160	110	6,7	50	66,30
518 2025	200	250	255	312	1000	63	160	110	90	200	160	110	6,8	40	69,20
518 2030	200	300	255	362	1000	63	160	110	90	200	160	110	7,3	35	72,00

dimensioni in mm - dimension in mm

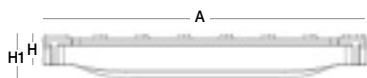

Griglia in ghisa sferoidale

Cast iron grid

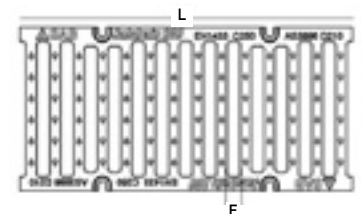

Grille en fonte

Rejilla de hierro dúctil

code	material	drain cm ²	A	H	H1	L	F	load class	Kg	Pack	€
704C10	cast iron - EN-GJS-500-7	220	146	20	20	500	86 x 16	C250	4,3	400	48,10
704C15	cast iron - EN-GJS-500-7	348	197	20	20	500	136 x 16	C250	5,8	280	59,70
704C20	cast iron - EN-GJS-500-7	494	247	20	40	500	186 x 18	C250	6,8	120	80,70

CODE
25 704D



D400



n.1 Canale PP con bordi in acciaio
n.2 Griglie in ghisa sferoidale
n.1 Fissaggio
n.8 zanche M10
n.8 viti M10x25

Steel edged
PP channel
Cast iron grids

Fix kit
n.8 anchors M10
n.8 screws M10x25

Caniveau PP
bordure en acier
Grilles en fonte

Kit de fixation
n. 8 pattes d'ancrage M10
n. 8 vis M10x25

Canal de PP con bordes de acero
Rejillas de hierro dúctil
Kit de fijación
n.8 anclajes M10
n.8 tornillos M10x25

CODE	L x H	L1 x H1	kg	pack	€/m	€/m	€/m	€/m
525 1005 704DS	100 x 50	150 x 100	13,2	70	169,50	43,50	110,40	15,60
525 1010 704DS	100 x 100	150 x 150	13,8	54	172,90	46,90	110,40	15,60
525 1015 704DS	100 x 150	150 x 200	14,3	45	177,60	51,60	110,40	15,60
525 1510 704DS	150 x 100	200 x 150	17,6	42	215,00	55,00	144,40	15,60
525 1515 704DS	150 x 150	200 x 200	18,3	30	220,00	60,00	144,40	15,60
525 2005 704DS	200 x 50	250 x 100	20,8	40	261,70	56,30	189,80	15,60
525 2010 704DS	200 x 100	250 x 150	21,3	35	264,60	59,20	189,80	15,60
525 2015 704DS	200 x 150	250 x 200	21,8	25	267,40	62,00	189,80	15,60
525 2020 704DS	200 x 200	250 x 250	22,3	20	271,70	66,30	189,80	15,60
525 2025 704DS	200 x 250	250 x 300	22,8	15	274,60	69,20	189,80	15,60
525 2030 704DS	200 x 300	250 x 350	23,3	15	277,40	72,00	189,80	15,60



CODE
25 704D



D400

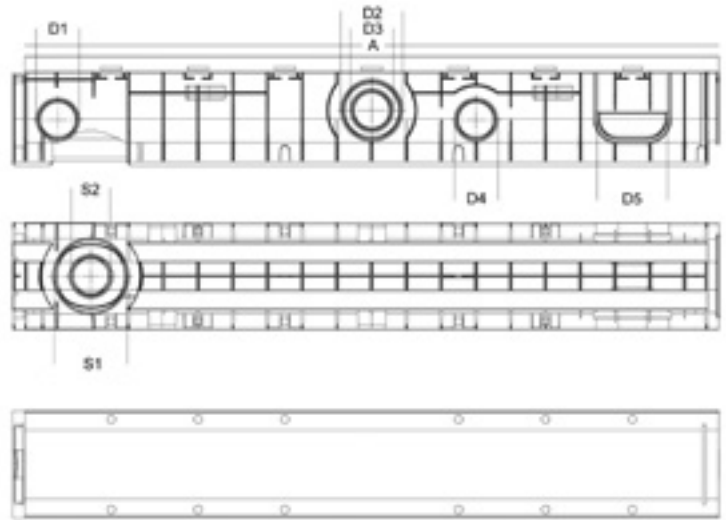
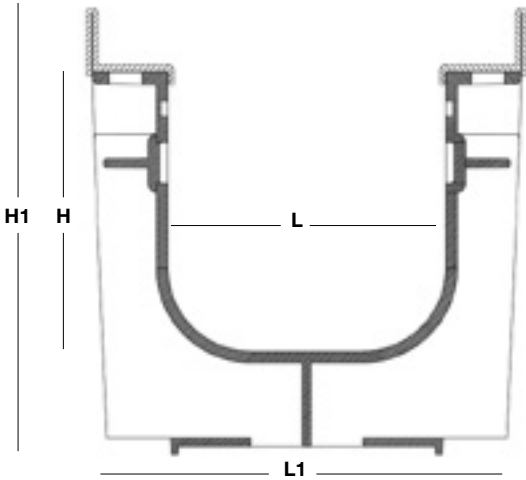

Canale PP con bordi in acciaio

Steel edged PP channel

Caniveau PP bordure en acier

Canal de PP con bordes de acero

code	L	H	L1	H1	A	D1	D2	D3	D4	D5	S1	S2	Kg	Pack	€
518 1005	100	50	152	112	1000	40	-	-	40	100	110	63	3,7	200	43,50
518 1010	100	100	152	162	1000	63	90	63	63	100	110	63	4,5	128	46,90
518 1015	100	150	152	212	1000	63	110	63	110	100	110	63	5,0	96	51,60
518 1510	150	100	200	167	1000	63	90	63	63	150	110	63	4,6	96	55,00
518 1515	150	150	200	212	1000	63	110	63	110	150	110	63	5,3	72	60,00
518 2005	200	50	255	106	1000	40	-	-	40	200	160	110	4,6	125	56,30
518 2010	200	100	255	162	1000	63	90	63	63	200	160	110	5,1	80	59,20
518 2015	200	150	255	212	1000	63	110	63	90	200	160	110	5,6	60	62,00
518 2020	200	200	255	262	1000	63	160	110	90	200	160	110	6,7	50	66,30
518 2025	200	250	255	312	1000	63	160	110	90	200	160	110	6,8	40	69,20
518 2030	200	300	255	362	1000	63	160	110	90	200	160	110	7,3	35	72,00

dimensioni in mm - dimension in mm

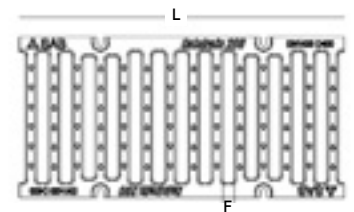
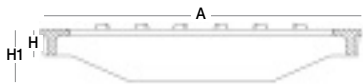

Griglia in ghisa sferoidale

Cast iron grid

Grille en fonte

Rejilla de hierro dúctil

code	material	drain cm ²	A	H	H1	L	F	load class	Kg	Pack	€
704D10	cast iron - EN-GJS-500-7	248	146	20	20	500	86 x 16	D400	4,9	150	55,20
704D15	cast iron - EN-GJS-500-7	348	197	20	30	500	136 x 16	D400	6,8	238	72,20
704D20	cast iron - EN-GJS-500-7	494	245	20	40	500	186 x 18	D400	7,8	100	94,90

Coperture cieche in ghisa sferoidale

Cast iron covers

Couvertures pleines en fonte

Tapas ciegas de hierro dúctil

code	material	drain cm ²	A	H	H1	L	F	load class	Kg	Pack	€
854D20	cast iron - EN-GJS-500-7	-	247	20	40	500	-	D400	8,9	100	106,00

*Optional

CODE
25 704F



- n.1 Canale PP con bordi in acciaio
- n.2 Griglie in ghisa sferoidale
- n.1 Fissaggio
n.8 zanche M10
n.8 viti M10x25

Steel edged
PP channel
Cast iron grids

Fix kit
n.8 anchors M10
n.8 screws M10x25

Caniveau PP
bordure en acier
Grilles en fonte

Kit de fixation
n. 8 pattes d'ancrage M10
n. 8 vis M10x25

Canal de PP con
bordes de acero
Rejillas de
hierro dúctil
Kit de fijación
n.8 anclajes M10
n.8 tornillos M10x25

CODE	L x H	L1 x H1	kg	pack	€/m	€/m	€/m	€/m
525 1005 704FS	100 x 50	150 x 100	15,6	70	173,30	43,50	114,20	15,60
525 1010 704FS	100 x 100	150 x 150	16,2	54	176,70	46,90	114,20	15,60
525 1015 704FS	100 x 150	150 x 200	16,7	45	181,40	51,60	114,20	15,60
525 1510 704FS	150 x 100	200 x 150	22,6	42	240,60	55,00	170,00	15,60
525 1515 704FS	150 x 150	200 x 200	23,3	30	245,60	60,00	170,00	15,60
525 2005 704FS	200 x 50	250 x 100	32,6	40	288,90	56,30	217,00	15,60
525 2010 704FS	200 x 100	250 x 150	33,1	35	291,80	59,20	217,00	15,60
525 2015 704FS	200 x 150	250 x 200	33,6	25	294,60	62,00	217,00	15,60
525 2020 704FS	200 x 200	250 x 250	34,1	20	298,90	66,30	217,00	15,60
525 2025 704FS	200 x 250	250 x 300	34,6	15	301,80	69,20	217,00	15,60
525 2030 704FS	200 x 300	250 x 350	35,1	15	304,60	72,00	217,00	15,60



CODE
25 704F

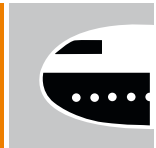

F900

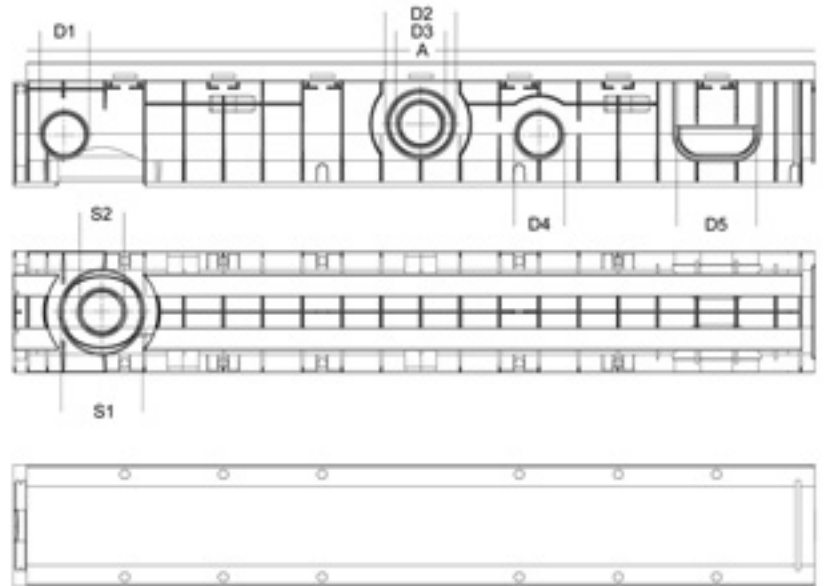
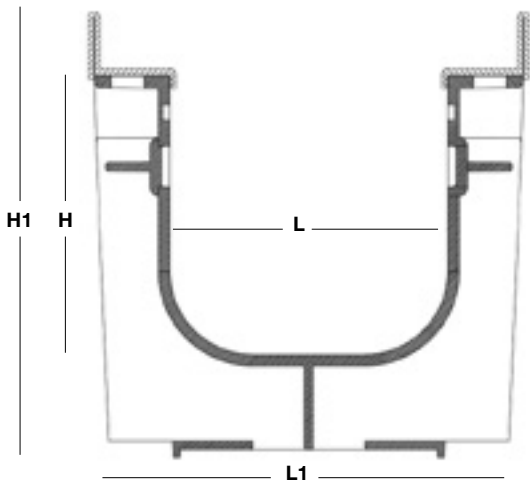

Canale PP con bordi in acciaio

Steel edged PP channel

Caniveau PP bordure en acier

Canal de PP con bordes de acero

code	L	H	L1	H1	A	D1	D2	D3	D4	D5	S1	S2	Kg	Pack	€
518 1005	100	50	152	112	1000	40	-	-	40	100	110	63	3,7	200	43,50
518 1010	100	100	152	162	1000	63	90	63	63	100	110	63	4,5	128	46,90
518 1015	100	150	152	212	1000	63	110	63	110	100	110	63	5,0	96	51,60
518 1510	150	100	200	167	1000	63	90	63	63	150	110	63	4,6	96	55,00
518 1515	150	150	200	212	1000	63	110	63	110	150	110	63	5,3	72	60,00
518 2005	200	50	255	106	1000	40	-	-	40	200	160	110	4,6	125	56,30
518 2010	200	100	255	162	1000	63	90	63	63	200	160	110	5,1	80	59,20
518 2015	200	150	255	212	1000	63	110	63	90	200	160	110	5,6	60	62,00
518 2020	200	200	255	262	1000	63	160	110	90	200	160	110	6,7	50	66,30
518 2025	200	250	255	312	1000	63	160	110	90	200	160	110	6,8	40	69,20
518 2030	200	300	255	362	1000	63	160	110	90	200	160	110	7,3	35	72,00

dimensioni in mm - dimension in mm

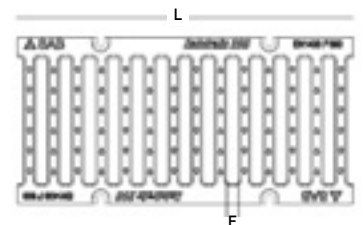
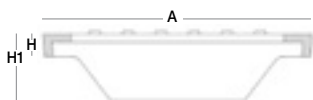

Griglia in ghisa sferoidale

Cast iron grid

Grille en fonte

Rejilla de hierro dúctil

code	material	drain cm ²	A	H	H1	L	F	load class	Kg	Pack	€
704F10	cast iron - EN-GJS-500-7	220	147	20	27	500	86 x 16	F900	5,6	150	57,10
704F15	cast iron - EN-GJS-500-7	348	197	20	45	500	136 x 16	F900	9,5	100	85,00
704F20	cast iron - EN-GJS-500-7	476	247	20	60	500	186 x 18	F900	13,8	50	108,50

CODE

25 704...



- n.1** Canale PP con bordi in acciaio
- n.1** Griglia in ghisa sferoidale
- n.1** Fissaggio
n.4 zanche M10
n.4 viti M10x30

 Steel edged
PP channel
Cast iron grid

 Fix kit
n.4 anchors M10
n.4 screws M10x30

 Caniveau PP
bordure en acier
Grille en fonte

 Kit de fixation
n. 4 pattes d'ancrage M10
n. 4 vis M10x30

 Canal de PP con
bordes de acero
Rejilla de
hierro dúctil
Kit de fijación
n.4 anclajes M10
n.4 tornillos M10x30

C250	L x H	L1 x H1	kg	pack	€/0,5m	€/0,5m	€/0,5m	€/0,5m
525 3020 704CS	300 x 200	390 x 260	18,8	24	215,00	72,70	134,50	7,80
525 3030 704CS	300 x 300	390 x 360	19,2	18	220,70	78,40	134,50	7,80
D400								
525 3020 704DS	300 x 200	390 x 260	23,4	24	241,00	72,70	160,50	7,80
525 3030 704DS	300 x 300	390 x 360	23,8	18	246,70	78,40	160,50	7,80
NEW 525 5050 704DS	500 x 500	590 x 560	45,0	8	482,80	115,50	359,50	7,80
F900								
525 3020 704FS	300 x 200	390 x 260	32,2	24	331,00	72,70	250,50	7,80
525 3030 704FS	300 x 300	390 x 360	32,6	18	336,70	78,40	250,50	7,80
NEW 525 5050 704FS	500 x 500	590 x 560	56,7	8	596,80	115,50	473,50	7,80

Disponibile in elementi da 500 mm o da 1000 mm.
Elements available both length 500 mm and 1000 mm.



CODE
25 704...

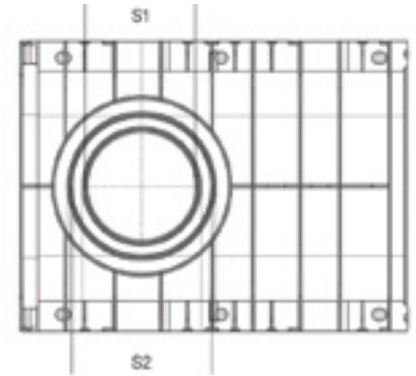
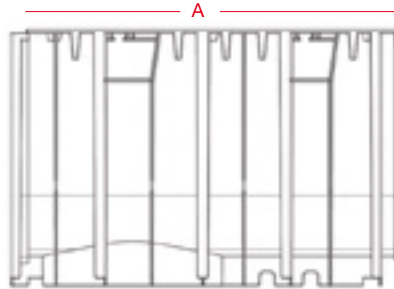
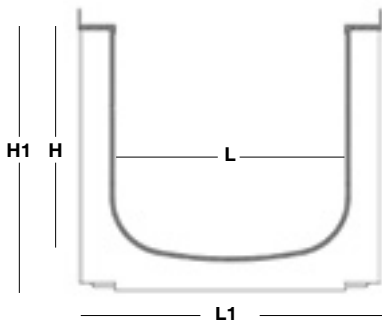

Canale PP con bordi in acciaio

Steel edged PP channel

Caniveau PP bordure en acier

Canal de PP con bordes de acero

code	L	H	L1	H1	A	S1	S2	S3	S4	S5	Kg	Pack	€
518 3020	300	200	390	260	500	160	200	-	-	-	4,6	60	72,70
518 3030	300	300	390	360	500	160	200	-	-	-	5,0	42	78,40
518 5050	500	500	590	560	500	160	200	250	315	400	9,8	16	115,50

dimensioni in mm - dimension in mm

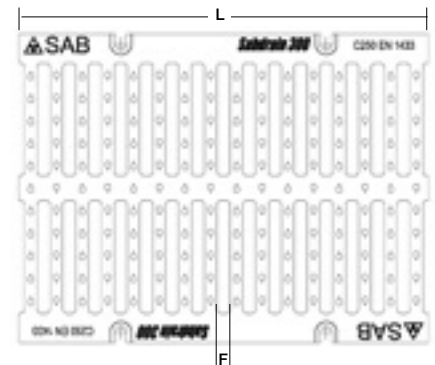
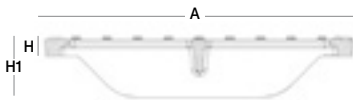

Griglia in ghisa sferoidale

Cast iron grid

Grille en fonte

Rejilla de hierro dúctil

code	material	drain cm ²	A	H	H1	L	F	load class	Kg	Pack	€
704C30	cast iron - EN-GJS-500-7	756	376	20	50	500	150 x18	C250	12,9	60	134,50
704D30	cast iron - EN-GJS-500-7	756	376	20	50	500	150 x18	D400	16,7	60	160,50
704F30	cast iron - EN-GJS-500-7	618	376	20	60	500	138 x18	F900	25,8	60	250,50
704D50	cast iron - EN-GJS-500-7	1070	580	20	60	500	165 x18	D400	34,8	32	359,50
704F50	cast iron - EN-GJS-500-7	1070	576	20	85	500	165 x18	F900	52,7	32	473,50

Coperture cieche in ghisa sferoidale

Cast iron covers

Couvertures pleines en fonte

Tapas ciegas de hierro dúctil

code	material	drain cm ²	A	H	H1	L	F	load class	Kg	Pack	€
854D30	cast iron - EN-GJS-500-7	-	376	20	50	500	-	D400	20,8	60	186,00

*Optional



CODE
25 707C



C250

Heel Guard

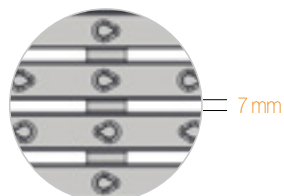

n.1 Canale PP con bordi in acciaio
n.2 Griglie in ghisa
heel guard
n.1 Fissaggio
n.8 zanche M10
n.8 viti M10x25

Steel edged PP channel
heel guard
cast iron grids
Fix kit
n.8 anchors M10
n.8 screws M10x25

Caniveau PP bordure en acier
Grille en fonte
heel guard
Kit de fixation
n. 8 pattes d'ancrage M10
n. 8 vis M10x25

Canal de PP con bordes de acero
Rejillas de hierro dúctil **anti-tacón**
Kit de fijación
n.8 anclajes M10
n.8 tornillos M10x25



L x H



L1 x H1



kg



pack



€/m



€/m



€/m



€/m

CODE	L x H	L1 x H1	kg	pack	€/m	€/m	€/m	€/m
525 1005 707CS	100 x 50	150 x 100	16,2	70	172,90	43,50	113,80	15,60
525 1010 707CS	100 x 100	150 x 150	16,8	54	176,30	46,90	113,80	15,60
525 1015 707CS	100 x 150	150 x 200	17,3	45	181,00	51,60	113,80	15,60
525 1510 707CS	150 x 100	200 x 150	21,8	42	223,80	55,00	153,20	15,60
525 1515 707CS	150 x 150	200 x 200	22,5	30	228,80	60,00	153,20	15,60
525 2005 707CS	200 x 50	250 x 100	26,6	40	276,90	56,30	205,00	15,60
525 2010 707CS	200 x 100	250 x 150	27,1	35	279,80	59,20	205,00	15,60
525 2015 707CS	200 x 150	250 x 200	27,6	25	282,60	62,00	205,00	15,60
525 2020 707CS	200 x 200	250 x 250	28,1	20	286,90	66,30	205,00	15,60
525 2025 707CS	200 x 250	250 x 300	28,6	15	289,80	69,20	205,00	15,60
525 2030 707CS	200 x 300	250 x 350	29,1	15	292,60	72,00	205,00	15,60

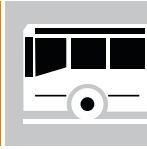
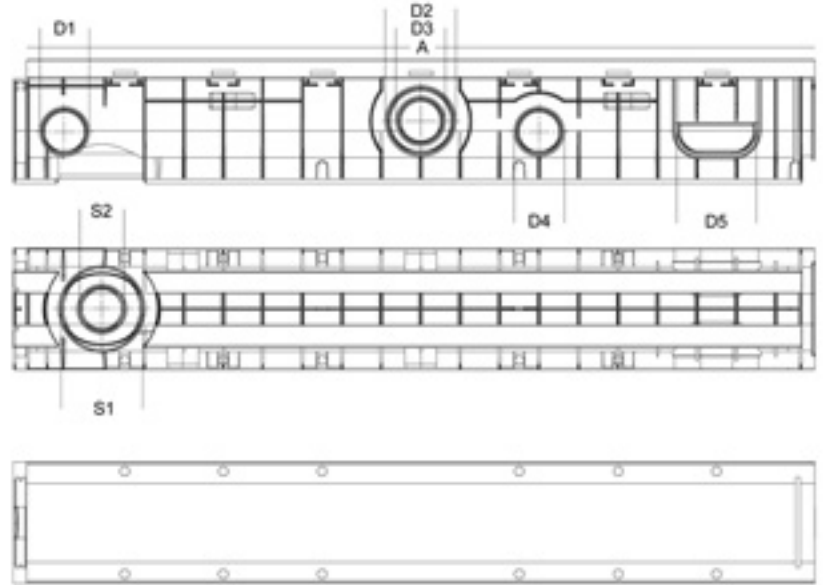
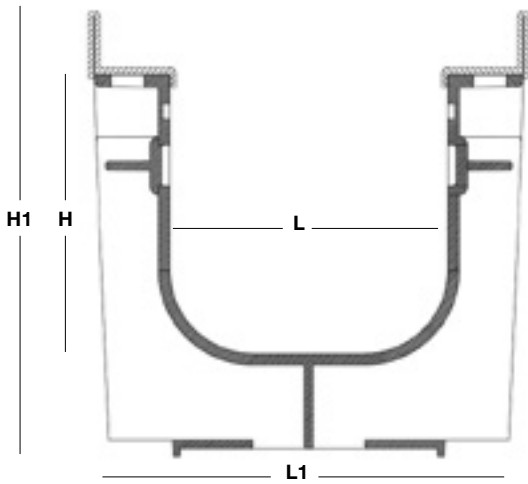
CODE
25 707C

C250

Canale PP con bordi in acciaio
Steel edged PP channel
Caniveau PP bordure en acier
Canal de PP con bordes de acero

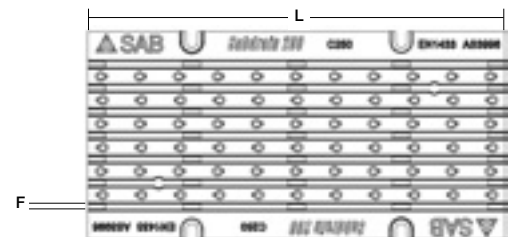
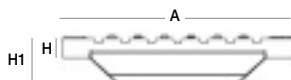
code	L	H	L1	H1	A	D1	D2	D3	D4	D5	S1	S2	Kg	Pack	€
518 1005	100	50	152	112	1000	40	-	-	40	100	110	63	3,7	200	43,50
518 1010	100	100	152	162	1000	63	90	63	63	100	110	63	4,5	128	46,90
518 1015	100	150	152	212	1000	63	110	63	110	100	110	63	5,0	96	51,60
518 1510	150	100	200	167	1000	63	90	63	63	150	110	63	4,6	96	55,00
518 1515	150	150	200	212	1000	63	110	63	110	150	110	63	5,3	72	60,00
518 2005	200	50	255	106	1000	40	-	-	40	200	160	110	4,6	125	56,30
518 2010	200	100	255	162	1000	63	90	63	63	200	160	110	5,1	80	59,20
518 2015	200	150	255	212	1000	63	110	63	90	200	160	110	5,6	60	62,00
518 2020	200	200	255	262	1000	63	160	110	90	200	160	110	6,7	50	66,30
518 2025	200	250	255	312	1000	63	160	110	90	200	160	110	6,8	40	69,20
518 2030	200	300	255	362	1000	63	160	110	90	200	160	110	7,3	35	72,00

dimensioni in mm - dimension in mm



Griglia in ghisa sferoidale
Cast iron grid
Grille en fonte
Rejilla de hierro dúctil

code	material	drain cm ²	A	H	H1	L	F	load class	Kg	Pack	€
707C10	cast iron - EN-GJS-500-7	81	147	20	36	500	498 x 7	C250	5,9	132	56,90
707C15	cast iron - EN-GJS-500-7	137	197	20	47	500	498 x 7	C250	8,3	96	76,60
707C20	cast iron - EN-GJS-500-7	191	247	20	47	500	498 x 7	C250	10,0	78	102,50

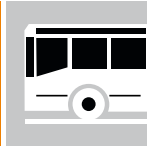

// Price list

CODE
25 707C



C250

Heel Guard

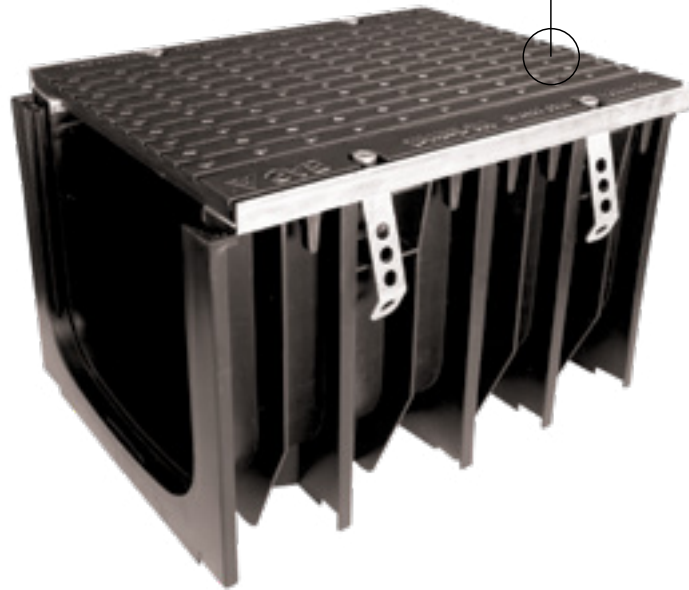
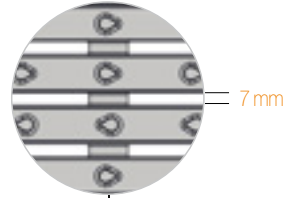

- n.1 Canale PP con bordi in acciaio
- n.1 Griglia in ghisa heel guard
- n.1 Fissaggio
n.4 zanche M10
n.4 viti M10x30

Steel edged
PP channel
heel guard
cast iron grid
Fix kit
n.4 anchors M10
n.4 screws M10x30

Caniveau PP
bordure en acier
Grille en fonte
heel guard
Kit de fixation
n. 4 pattes d'ancrage M10
n. 4 vis M10x30

Canal de PP
con bordes de acero
Rejilla de hierro dúctil anti-tacón
Kit de fijación
n.4 anclajes M10
n.4 tornillos M10x30



L x H



L1 x H1



kg



pack



€/0,5m



€/0,5m



€/0,5m



€/0,5m

CODE

525 3020 707CS

300 x 200

390 x 260

20,5

24

234,00

72,70

153,50

7,80

525 3030 707CS

300 x 300

390 x 360

20,5

18

239,70

78,40

153,50

7,80

Disponibile in elementi da 500 mm o da 1000 mm.
Elements available both length 500 mm and 1000 mm.



CODE
25 707C

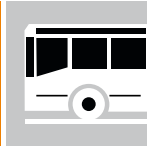

C250

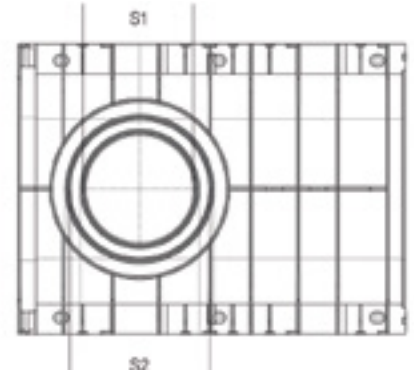
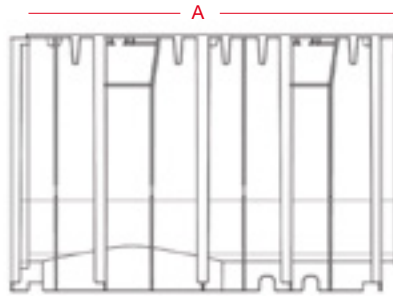
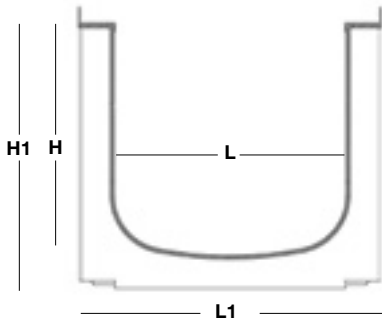

Canale PP con bordi in acciaio

Steel edged PP channel

Caniveau PP bordure en acier

Canal de PP con bordes de acero

code	L	H	L1	H1	A	S5	S4	S3	S2	S1	Kg	Pack	€
518 3020	300	200	390	260	500	-	-	-	200	160	4,6	60	72,70
518 3030	300	300	390	360	500	-	-	-	200	160	5,0	42	78,40

dimensioni in mm - dimension in mm

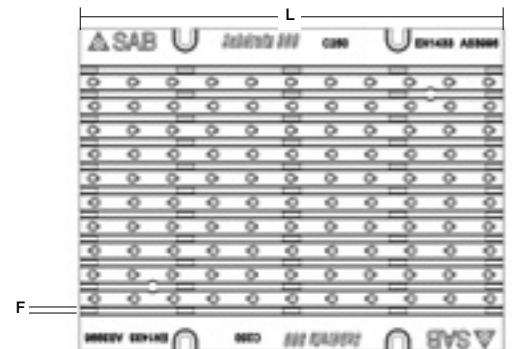

Griglia in ghisa sferoidale

Cast iron grid

Grille en fonte

Rejilla de hierro dúctil

code	material	drain cm ²	A	H	H1	L	F	load class	Kg	Pack	€
707C30	cast iron - EN-GJS-500-7	273	376	20	47	500	498 x 7	C250	15,5	60	153,50

CODE
10 570L

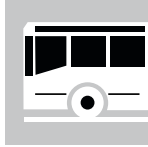

C250



n.1 Canale PP con
bordi in plastica
n.1 Griglia a feritoia
acciaio zincato

Plastic edged
PP channel
Galvanized
steel slot grid

Caniveau PP
bordure en plastique
Grille à fente
en acier galvanisé

Canal de PP con
bordes de plástico
Rejilla ranurada
de acero galvanizado

CODE	L x H	L1 x H1	kg	pack	€/m	€/m	€/m
510 1005 570LZ	100 x 50	150 x 100	9,3
510 1010 570LZ	100 x 100	150 x 150	9,9
510 1015 570LZ	100 x 150	150 x 200	10,4
510 1510 570LZ	150 x 100	200 x 150	11,1
510 1515 570LZ	150 x 150	200 x 200	11,8
510 2010 570LZ	200 x 100	250 x 150	12,6
510 2015 570LZ	200 x 150	250 x 200	13,1
510 2020 570LZ	200 x 200	250 x 250	13,6
510 2025 570LZ	200 x 250	250 x 300	14,1
510 2030 570LZ	200 x 300	250 x 350	14,6

Quotazioni su richiesta. / Prices on demand.
Prix sur demande. / Cotización sobre pedido.



CODE
10 570L



C250

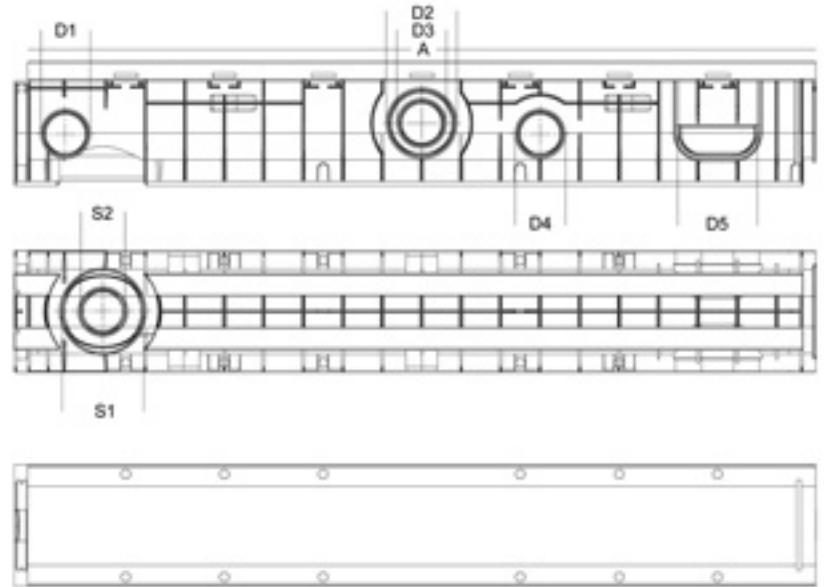
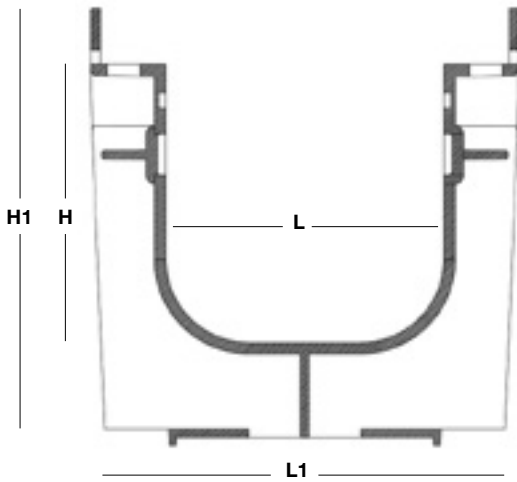

Canale PP con bordi in plastica

Plastic edged PP channel

Caniveau PP bordure en plastique

Canal de PP con bordes de plástico

code	L	H	L1	H1	A	D1	D2	D3	D4	D5	S1	S2	Kg	Pack	€
510 1005	100	50	152	106	1000	40	-	-	40	100	110	63	3,7	200	18,50
510 1010	100	100	152	157	1000	63	90	63	63	100	110	63	4,5	128	21,90
510 1015	100	150	152	210	1000	63	110	63	110	100	110	63	5,0	96	26,60
510 1510	150	100	200	160	1000	63	90	63	63	150	110	63	4,6	96	29,90
510 1515	150	150	200	210	1000	63	110	63	110	150	110	63	5,3	72	35,00
510 2010	200	100	255	158	1000	63	90	63	63	200	160	110	5,1	80	34,10
510 2015	200	150	255	210	1000	63	110	63	90	200	160	110	5,6	60	37,00
510 2020	200	200	255	260	1000	63	160	110	90	200	160	110	6,7	50	41,30
510 2025	200	250	255	310	1000	63	160	110	90	200	160	110	6,6	40	44,10
510 2030	200	300	255	360	1000	63	160	110	90	200	160	110	7,3	35	47,00

dimensioni in mm - dimension in mm

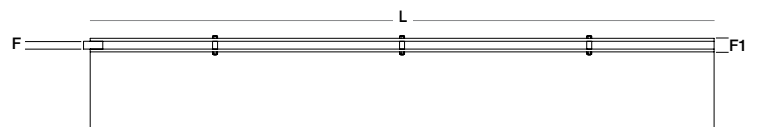
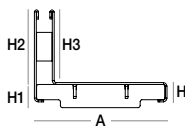

Griglia a feritoia acciaio zincato

Galvanized steel slot grid

Grille à fente en acier galvanisé

Rejilla ranurada de acero galvanizado

code	material	drain cm ²	A	H	H1	H2	H3	L	F	F1	load class	Kg	Pack	€
706C10L	steel	130	145	20	25	100	79	1000	13	21,5	C250	7,5
706C15L	steel	130	196	20	30	100	79	1000	13	21,5	C250	8,5
706C20L	steel	130	246	20	30	100	79	1000	13	21,5	C250	10,0

Altre dimensioni disponibili su richiesta.

More dimensions available on demand.

CODE
31 351A



A15



// Price list

- n.1 Pozzetto PP con bordi in plastica
- n.1 Griglia a fessura in PP
- n.1 Fissaggio

n.1 staffa zincata / n.1 vite 8x60

Plastic edged PP drain box
PP slotted grid
Fix kit

n.1 steel clamp / n.1 screw 8x60

Reagard PP bordure en plastique
Grille passerelle en PP
Kit de fixation

n. 1 clavette en acier galvanisé / n. 1 vis 8x60

Sumidero de PP con bordes de plástico
Rejilla ranurada de PP
Kit de fijación

n.1 abrazadera galvanizada / n.1 tornillo 8x60



CODE	L x H	L1 x H1	kg	pack	€/0,5m	€/0,5m	€/0,5m	€/0,5m
531 10 351AP	100 x 400	150 x 430	3,20	48	73,78	58,10	5,28	10,40

CODE
31 501A



A15

- n.1 Pozzetto PP con bordi in plastica
- n.1 Griglia a fessura acciaio zincato
- n.1 Fissaggio

n.1 staffa zincata / n.1 vite 8x60

Plastic edged PP drain box
Galvanized steel slotted grid
Fix kit

n.1 steel clamp / n.1 screw 8x60

Regard bordure en plastique
Grille passerelle en acier galvanisé
Kit de fixation

n. 1 clavette en acier galvanisé / n. 1 vis 8x60

Sumidero de PP con bordes de plástico
Rejilla ranurada de acero galvanizado
Kit de fijación

n.1 abrazadera galvanizada / n.1 tornillo 8x60



CODE	L x H	L1 x H1	kg	pack	€/0,5m	€/0,5m	€/0,5m	€/0,5m
531 10 501AZ	100 x 400	150 x 430	3,40	48	85,70	58,10	17,20	10,40
531 15 501AZ	150 x 400	200 x 430	4,00	36	120,90	80,80	27,20	12,90
531 20 501AZ	200 x 400	250 x 430	5,10	30	158,70	104,00	39,30	15,40

CODE
31 355...



B125

- n.1 Pozzetto PP con bordi in plastica
- n.1 Griglia PAFV
- n.1 Fissaggio

n.1 staffa zincata / n.1 vite 8x60

Plastic edged PP drain box
PAFV grid
Fix kit

n.1 steel clamp / n.1 screw 8x60

Regard bordure en plastique
Grille en PAFV
Kit de fixation

n. 1 clavette en acier galvanisé / n. 1 vis 8x60

Sumidero de PP con bordes de plástico
Rejilla PAFV
Kit de fijación

n.1 abrazadera galvanizada / n.1 tornillo 8x60



CODE	L x H	L1 x H1	kg	pack	€/0,5m	€/0,5m	€/0,5m	€/0,5m
531 10 355BP	100 x 400	150 x 430	3,60	48	98,35	58,10	29,85	10,40
531 15 355BP	150 x 400	200 x 430	4,40	36	139,55	80,80	45,85	12,90



C250

531 10 355CP	100 x 400	150 x 430	3,70	48	104,85	58,10	36,35	10,40
--------------	-----------	-----------	------	----	--------	-------	-------	-------

CODE
31 704C



C250

back to index // Price list

n.1 Pozzetto PP con bordi in plastica
n.1 Griglia in ghisa sferoidale
n.1 Fissaggio
 n. 4 viti M10x25 / n. 4 piastri
 Plastic edged PP drain box
 Cast iron grid
 Fix kit
 n.4 screws M10x25 / n.4 threaded plates

Regard bordure en plastique
 Grille en fonte
 Kit de fixation
 n. 4 vis M10x25 / n. 4 plaques filetées
 Sumidero de PP con bordes de plástico
 Rejilla de hierro dúctil
 Kit de fijación
 n.4 tornillos M10x25 / n.4 chapetas



CODE								
	L x H	L1 x H1	kg	pack	€/0,5m	€/0,5m	€/0,5m	€/0,5m
531 10 704C	100 x 400	200 x 430	8,10	48	110,90	58,10	48,60	4,20
531 15 704C	150 x 400	250 x 430	9,70	36	145,20	80,80	60,20	4,20
531 20 704C	200 x 400	250 x 430	11,00	30	189,40	104,00	81,20	4,20

CODE
33 531...

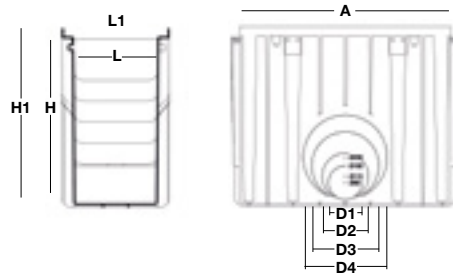

Pozzetto PP con bordi in plastica

Plastic edged PP drain box

Regard bordure en plastique

Sumidero de PP con bordes de plástico

code	L	H	L1	H1	A	D1	D2	D3	D4	D5	S1	S2	Kg	Pack	€
53110	100	400	150	430	500	80	110	160	200	-	-	-	2,50	60	58,10
53115	150	400	200	430	500	80	110	160	200	-	-	-	2,60	48	80,80
53120	200	400	250	430	500	80	110	160	200	-	-	-	2,90	40	104,00

dimensioni in mm - dimension in mm











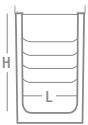
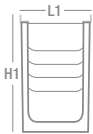



CODE
33 355...

 back to index // Price list

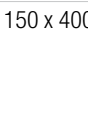
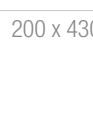
n.1 Pozzetto PP con bordi in acciaio
n.1 Griglia PAFV
n.1 Fissaggio
 n.1 staffa zincata / n.1 vite 8x60
 Steel edged PP drain box
 PAGF grid
 Fix kit
 n.1 steel clamp / n.1 screw 8x60

Regard bordure en acier
 Grille en PAFV
 Kit de fixation
 n. 1 clavette en acier galvanisé / n. 1 vis 8x60
 Sumidero de PP con bordes de acero
 Rejilla PAFV
 Kit de fijación
 n.1 abrazadera galvanizada / n.1 tornillo 8x60















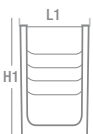







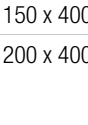
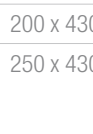

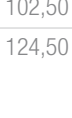

 B125 CODE	 L x H	 L1 x H1	 kg	 pack	 €/0,5m	 €/0,5m	 €/0,5m	 €/0,5m
533 10 355BS	100 x 400	150 x 430	4,70	48	119,05	78,80	29,85	10,40
533 15 355BS	150 x 400	200 x 430	5,40	36	161,25	102,50	45,85	12,90
 C250 CODE	 L x H	 L1 x H1	 kg	 pack	 €/0,5m	 €/0,5m	 €/0,5m	 €/0,5m
533 10 355CS	100 x 400	150 x 430	4,80	48	125,55	78,80	36,35	10,40

CODE
33 704...

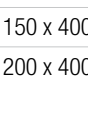
n.1 Pozzetto PP con bordi in acciaio
n.1 Griglia in ghisa sferoidale
n.1 Fissaggio
 n.4 zanche M10 / n.4 viti M10x25
 Steel edged PP drain box
 Cast iron grid
 Fix kit
 n.4 anchors M10 / n.4 screws M10x25

Regard bordure en acier
 Grille en fonte
 Kit de fixation
 n. 4 pattes d'ancrage M10 / n. 4 vis M10x25
 Sumidero de PP con bordes de acero
 Rejilla de hierro dúctil
 Kit de fijación
 n.4 anclajes M10 / n.4 tornillos M10x25

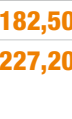
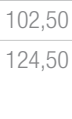

 C250 CODE	 L x H	 L1 x H1	 kg	 pack	 €/0,5m	 €/0,5m	 €/0,5m	 €/0,5m
533 10 704CS	100 x 400	150 x 430	8,1	48	134,70	78,80	48,10	7,80
533 15 704CS	150 x 400	200 x 430	9,7	36	170,00	102,50	59,70	7,80
533 20 704CS	200 x 400	250 x 430	11,3	30	213,00	124,50	80,70	7,80
 D400 CODE	 L x H	 L1 x H1	 kg	 pack	 €/0,5m	 €/0,5m	 €/0,5m	 €/0,5m
533 10 704DS	100 x 400	150 x 430	8,2	48	141,80	78,80	55,20	7,80
533 15 704DS	150 x 400	200 x 430	10,1	36	182,50	102,50	72,20	7,80
533 20 704DS	200 x 400	250 x 430	12,0	30	227,20	124,50	94,90	7,80
 F900 CODE	 L x H	 L1 x H1	 kg	 pack	 €/0,5m	 €/0,5m	 €/0,5m	 €/0,5m
533 10 704FS	100 x 400	150 x 430	9,4	48	143,70	78,80	57,10	7,80
533 15 704FS	150 x 400	200 x 430	12,6	36	195,30	102,50	85,00	7,80
533 20 704FS	200 x 400	250 x 430	17,9	30	240,80	124,50	108,50	7,80

CODE
33 707C

 back to index // Price list

n.1 Pozzetto PP con bordi in acciaio
n.1 Griglia in ghisa heel guard
n.1 Fissaggio

n. 4 zanche M10 / n.4 viti M10x25

Steel edged PP drain box
heel guard cast iron grid
Fix kit

n.4 anchors M10 / n. 4 screws M10x25

Regard bordure en acier
Grille en fonte heel guard
Kit de fixation

n. 4 pattes d'ancrage M10 / n. 4 vis M10x25

Sumidero de PP con bordes de acero
Rejilla de hierro dúctil anti-tacón
Kit de fijación

n.4 anclajes M10 / n.4 tornillos M10x25



CODE	L x H	L1 x H1	kg	pack	€/0,5m	€/0,5m	€/0,5m	€/0,5m
533 10 707CS	100 x 400	150 x 430	6,50	48	143,50	78,80	56,90	7,80
533 15 707CS	150 x 400	200 x 430	12,20	36	186,90	102,50	76,60	7,80
533 20 707CS	200 x 400	250 x 430	14,90	30	234,80	124,50	102,50	7,80

CODE
33 533...

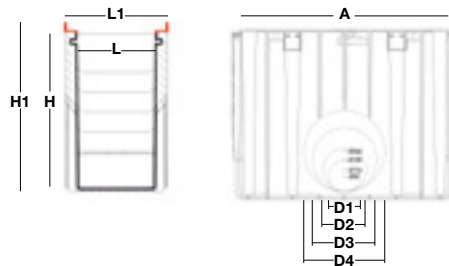

Pozzetto PP con bordi in acciaio

Steel edged PP drain box

Regard bordure en acier

Regard bordure en acier Grille en PAGF

code	L	H	L1	H1	A	D1	D2	D3	D4	D5	S1	S2	Kg	Pack	€
53310	100	400	150	430	500	80	110	160	200	-	-	-	3,6	60	78,80
53315	150	400	200	430	500	80	110	160	200	-	-	-	3,7	48	102,50
53320	200	400	250	430	500	80	110	160	200	-	-	-	4,0	40	124,50

dimensioni in mm - dimension in mm

ACCESSORIO - Cesto raccogli detriti / OPTIONAL - Debris collection basket
ACCESSOIRE - Panier décanteur / ACCESSORIO - Cestillo de acumulación de escombros

code	material	H	L	Kg	Pack	€
5010100	steel	200	85	2,7	1	130,00
5010150	steel	200	135	3,2	1	136,00
5010200	steel	200	185	3,7	1	142,00

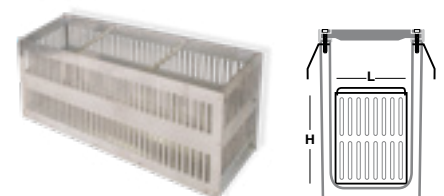



Supporto per installazione

Installation support
Support d'installation
Soporte de instalación

code	material	Pack	€/pc
5006 0000	PP	10	2,85



Inserto per asfalto drenante

Insert for draining asphalt
Insert pour goudron drainant
Inserto para asfalto drenante

code	material	drain cm ²	A	H	L	load class	Kg	Pack	€	€/m
50002010050	PAGF	56	25	20	500	D400	0,2	20	5,69	22,76

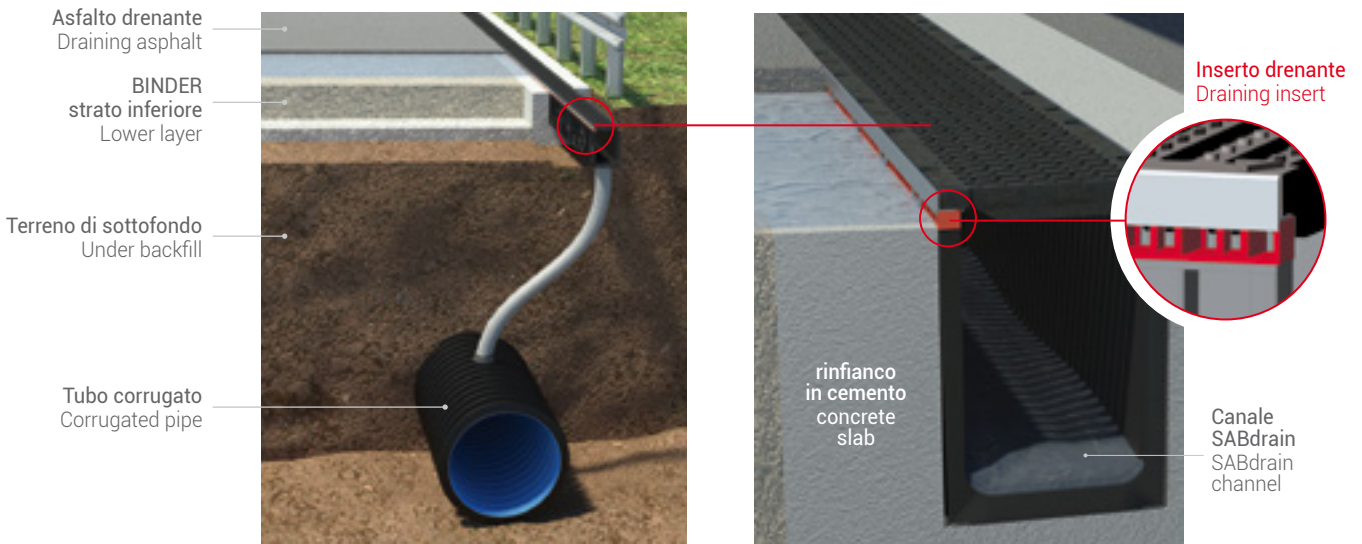

Tappo di salto

Stepped fall cap
Tapón de salto
Bouchon à cascade

	CODE	
<p>H 50 L 100</p>	<p>5009 1005 € 11,40</p>	<p>100x50 100x100 100x150</p>
<p>H 50 L 150</p>	<p>5009 1505 € 14,30</p>	<p>150x100 150x150</p>
<p>H 50 L 200</p>	<p>5009 2005 € 17,10</p>	<p>200x100 200x150 200x200 200x250 200x300</p>
<p>H 100 L 300</p>	<p>5009 3010 € 28,50</p>	<p>300x200 300x300</p>



Paratie cieche
Blank end-plugs
Obturateurs
Tapones ciegos

CODE	L x H	Ø	pack	€
5006 1005	100 x 50	-	10	4,09
5006 1010	100 x 100	-	10	5,57
5006 1015	100 x 150	-	10	7,41
5006 1510	150 x 100	-	10	7,41
5006 1515	150 x 150	-	10	9,77
5006 2005	200 x 50	-	5	9,90
5006 2010	200x100	-	5	10,60
5006 2015	200 x 150	-	5	10,60
5006 2020	200 x 200	-	5	13,60
5006 2025	200 x 250	-	5	15,50
5006 2030	200 x 300	-	5	18,10
5006 3020	300 x 200	-	1	41,30
5006 3030	300 x 300	-	1	45,20
5006 5050	500 x 500	-	1	71,20

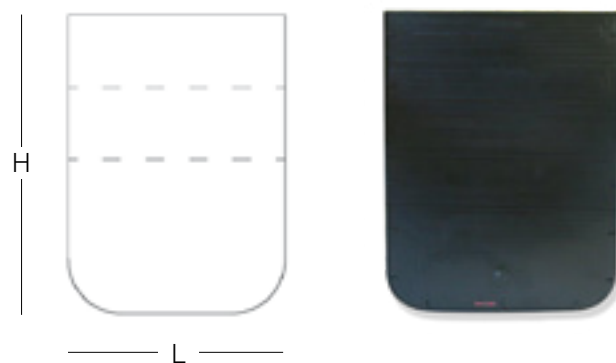

Paratie con derivazione
End-plugs with off-take
Obturateurs avec sortie
Tapones con derivaciones

CODE	L x H	Ø	pack	€
5006 1010 075	100 x 100	75	5	7,41
5006 1010 090	100 x 100	90	5	7,41
5006 1015 090	100 x 150	90	5	9,02
5006 1515 110	150 x 150	110	5	11,30
5006 2030 090	200 x 300	110	5	19,60
5006 2030 160	200 x 300	160	1	19,60
5006 1010 110	100 x 100	110	1	9,27

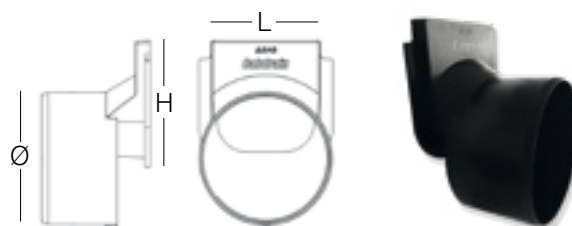

Derivazione per paratie
Spigot off-take
Derivación para tapones
Adaptateur de sortie

CODE	L x H	Ø	pack	€
5000 7040	-	40	5	1,24
5000 7090	-	90	5	1,49
5000 7110	-	110	2	1,79
5000 7160	-	160	1	3,03

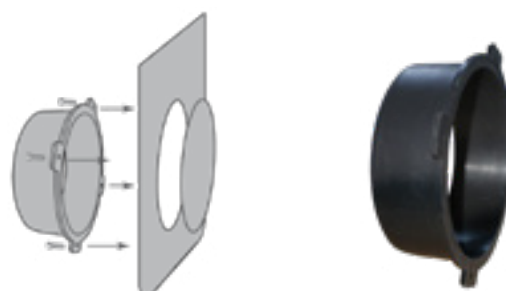

Grigliato in HDPE per prati carrabili

HDPE Grass saver
Dalle gazon en PEHD
Rejilla para césped en HDPE

VANTAGGI

Robusto
Leggero
Ecologico

ADVANTAGES

Strong
Light
Eco-friendly

AVANTAGES

Robuste
Lègere
Écologique

VENTAJAS

Robusto
Ligero
Ecológico

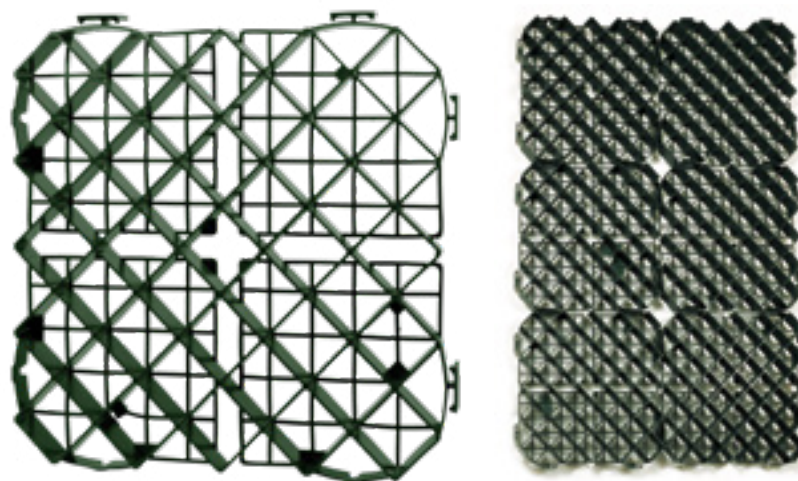

CODE: 07000	L mm	H mm	ton / m ²	pallet cm	pcs x plt	m ² x plt	pcs x m ²	€/pc	€/m ²
0700040V	395	40	200	120 x 80 x 120	162	25	6,5	5,72	37,20
0700050V	395	50	200	120 x 80 x 120	132	20	6,5	6,71	43,60

Installazione

Installation / Installation / Instalacion

Prato
Grass

GRAB su terreno
GRAB with suitable ground

Sabbia
Sand

Stabilizzato
Mixed gravel

Suolo del sito
Ground site

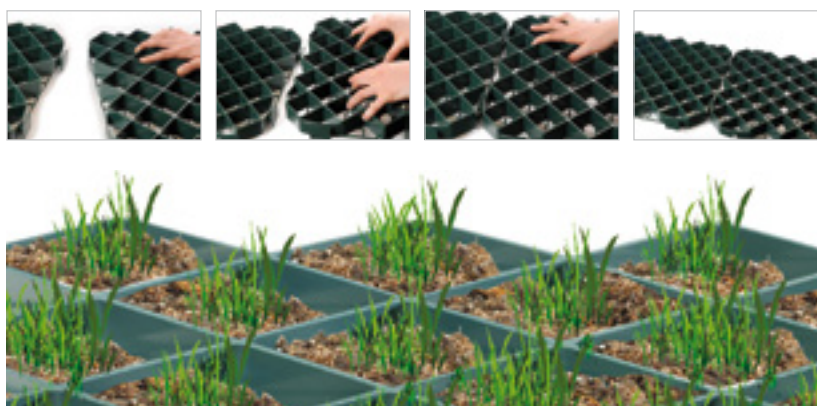

Embrice in PP per canale di scolo

PP Water run-off channel

Descente d'eau en PP

Alcantarillas para el drenaje de las aguas de carreteras en PP

VANTAGGI

Leggero
Sicuro
Veloce

ADVANTAGES

Light
Safe
Fast

AVANTAGES

Lègere
Sécure
Rapide

VENTAJAS

Ligero
Seguro
Rápido

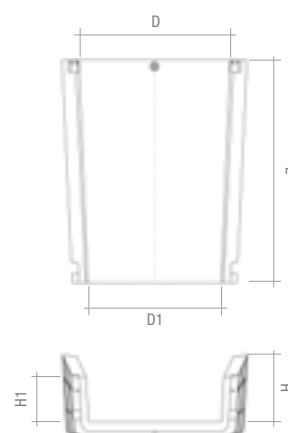

CODE: 50009

L mm

D mm

D1 mm

H mm

H1 mm

pallet cm

pcs x plt

€/pc

50009

500

340

300

150

100

130 x 110 x 220

120

29,70

Installazione

Installation / Installation / Instalacion



Il sistema Canyon è composto da singoli elementi, collegabili fra loro tramite incastratura manuale. L'aggancio avviene calando l'elemento superiore su quello inferiore. Il sistema di aggancio a perni consente una rotazione degli elementi da +20° a -20° rispetto l'asse mediano, consentendo adeguare il canyon alla pendenza del terreno dove viene posato.

The Canyon system is made up of individual parts which can be connected together by hand, placing the upper part over the lower one. The jointing system, carried out by means of cylindrical pins, allow the parts to rotate from +20° to -20°, thus allowing the channel system to follow the slope of the land.

Le système Canyon est composé d'éléments singuliers qui sont connectés entre eux à travers d'un ancrage manuel, en mettant l'élément supérieur sur celui inférieur. Une rotation des éléments est faisable de +20° à -20°, cela permet d'adapter la pose du système aux variations angulaires du plan de pose.

El sistema Canyon està compuesto por elementos singulares que se conectan entre ellos por medio de conexión manual, bajando la borateja superior sobre la inferior. Los pernos cilindricos permiten una rotación de los elementos desde +20° hasta -20° respecto al eje mediano, permitiendo de adaptar la instalación a las variaciones de la inclinación del terreno.



Componenti

Components

Griglie
Grids
Grilles
Rejillas

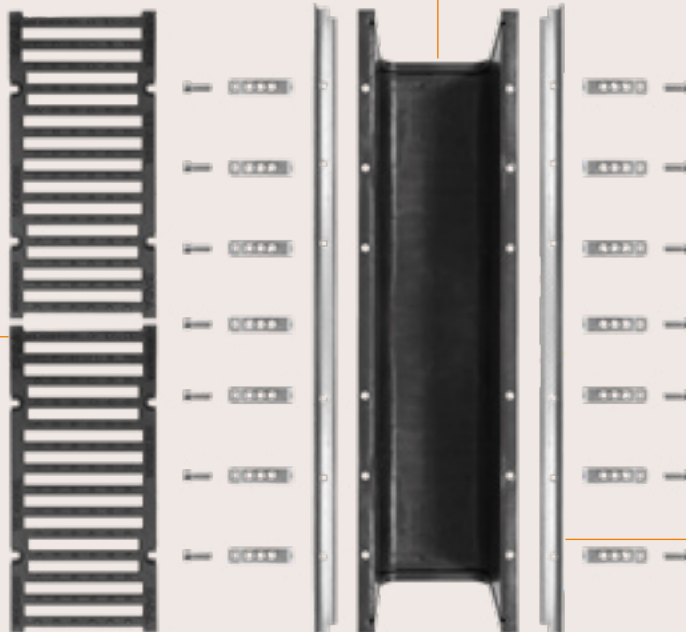

Canale
Channel
Caniveau
Canal

Viti e zanche
Screws and anchors
Vis et agraphes
Tornillos y anclajes

Profili di rinforzo
Reinforcing steel rail
Cornière en acier
Borde de protección

Montaggio del canale

Assembly of the channels

- A - **Inserire** i profili di rinforzo di metallo, **piazzare** le griglie (1)
- B - **Avvitare** e serrare viti e zanche (2), allargare le zanche a 45° (3)
- C - **Assemblare** fra loro i canali per il tratto che si desidera posare, ogni canale va inserito nel successivo fino a far scattare il dente di battuta (4)

- A - **Insert** the metal reinforcing rails, **assemble** the grids (1)
- B - **Screw** and tighten the screws and anchors (2), widen the anchors to an inclination of 45° to the channel (3)
- C - **Assemble** the channels together for the length desired. Every channel must be inserted into the next one all the way until the lip snaps into place (4)

- A - **Insérer** les cornières en acier, **placer** les grilles (1)
- B - **Visser** et serrer les vis et agraphes (2), écarter les agraphes à 45° par rapport au caniveau (3)
- C - **Assembler** les caniveaux entre eux pour la longueur voulue. Chaque caniveau est emboîté de manière à ce que ce dernier soit clipsé (4)

- A - **Insertar** los perfiles metalicos de refuerzo **colocar** las rejillas (1)
- B - **Atornillar** para sujetar las pestañas de sujeción (2), poner los anclajes a 45° (3)
- C - **Ensamblar** los diferentes canales entre ellos en el tramo que se desea instalar, cada canal viene insertado al siguiente hasta hacer saltar la pestaña de tope (4)

1



2



3



4





- A - Effettuare lo scavo a trincea di dimensioni adeguate (1), compattare il fondo.
- B - Gettare il letto in calcestruzzo di spessore adeguato (2).
- C - Posare i canali (3).
- D - Rinfiancare i lati del canale con idoneo calcestruzzo (vedi composizione del calcestruzzo) dello spessore indicato nelle tabelle di posa (4), il calcestruzzo deve essere vibrato e rinzaffato con estrema cura, deve riempire tutti gli interstizi ed essere compatto sotto i bordi del canale (5). Nelle classi di carico più elevate (E600 F900) è consigliabile un'armatura di ripartizione dei carichi.
- E - Quando il calcestruzzo si è solidificato procedere alla stesura della pavimentazione finale in asfalto, massetto o pavé, in questa fase è consigliabile coprire le griglie con della pellicola per evitare di sporcarle.

- A - Dig the trench of the proper size (1), the land shall be well pressed .
- B - Lay a bed of concrete of the recommended thickness (2).
- C - Lay the channel on the ground (3).
- D - Apply a lateral backfill onto the channel with suitable concrete and thickness as recommended. (4) the concrete should be vibrated and rendered and it should fill in all interstices, in particular behind the support edgings of the grids (5). For the heaviest load classes (E600, F900) we suggest reinforcing the concrete with steel rods for better load distribution.
- E - When the concrete is solidified it is possible to proceed with the flooring in asphalt, tiles or paving. During this step is recommended to cover the grids with a plastic film in order not to dirty them.

- A - Effectuer le creusement de tranchée avec les dimensions adéquates (1). Le fond doit être compacté.
- B - Couler le lit en béton d'une épaisseur adéquate (2).
- C - Poser les caniveaux (3).
- D - Remblayer les côtés du caniveau avec du béton (voir composition du béton) de l'épaisseur indiquée dans le tableau de pose (4), le béton doit être vibré et crépi avec soin, il doit remplir tous les interstices et être compact sous les bordures de caniveaux. Pour les classes de charges les plus élevées (E600 F900), il est conseillé une armature de répartition des charges (5).
- E - Quand le béton est solide procéder au dallage final en goudron, petit rocher ou pavé. A cette phase, il est conseillé de couvrir les grilles avec une pellicule pour éviter de les salir.

- A - Efectuar la excavación de la rasa con las dimensiones adecuadas (1), el lecho se debe compactar.
- B - Pavimentar el lecho con l'hormigón con un espesor adecuado (2).
- C - Posicionar los canales (3).
- D - Falcar la parte lateral de los canales con el hormigón adecuado (ver composición del hormigón) del espesor indicado en las tablas de instalación (4), el hormigón tiene que ser vibrado y reforzado con extrema delicadeza, debe rellenar todos los espacios y en especial debajo de los bordes del canal (5). En caso de cargas externas elevadas (E600 F900) es aconsejable una armadura de repartición de la carga.
- E - Cuando el hormigón esta fraguado se procede al extendido de la pavimentación final en asfalto, bordillo o adoquines, en esta fase es aconsejable cubrir la rejilla del canal con un manto de plástico o similar para no ensuciarla.

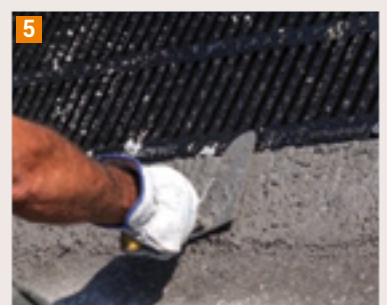



Asfalto, classi A15-C250
Asphalt, load classes A15-C250

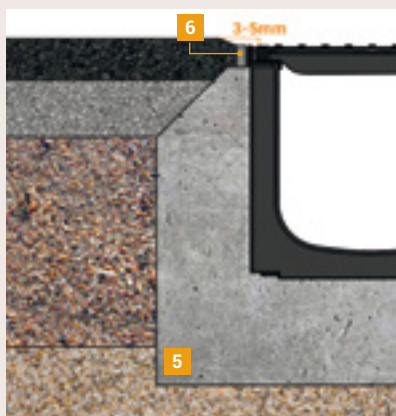

Asfalto, classi D400-F900
Asphalt, load classes D400-F900

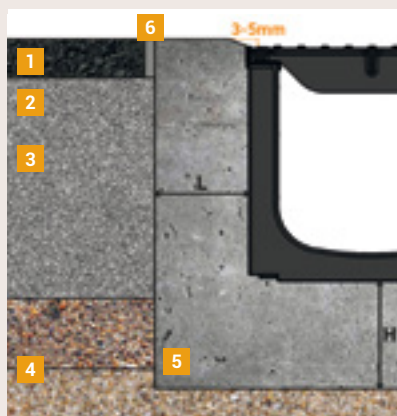

Asfalto drenante
Draining asphalt



Massetto in calcestruzzo,
classi A15-C250
Concrete slab, load classes
A15-C250

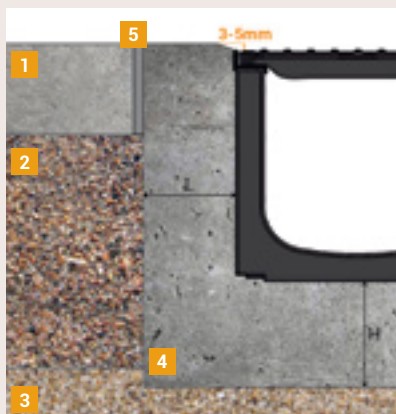

Massetto in calcestruzzo,
classi D400-F900
Concrete slab, load classes
D400-F900



Pavè
Self paving

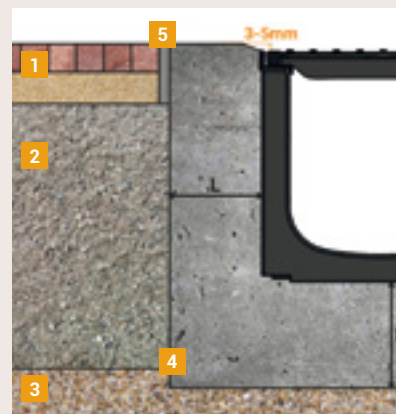

1	Strato di usura	Waring asphalt layer	Couche d'usure	Capa de desgaste
2	Strato inferiore (binder)	Lower layer (binder)	Couche inférieure	Capa inferior
3	Strato portante	Bearing layer	Couche porteuse	Capa de soporte
4	Terreno di sottofondo	Under backfill	Terrain double fond	Lecho
5	Rinfianco in calcestruzzo	Concrete backfill	Soutien en béton	Falcado lateral en hormigòn
6	Giunto di bitume	Bitumen joint	Joint en bitume	Tela asfáltica



back to index

// Technical features



SCHEDE TECNICHE DISPONIBILI
TECHNICAL SHEETS AVAILABLE



Disponibile libreria BIM
BIM library available
Bibliothèque BIM disponible
Librería BIM disponible



<input type="text" value="Inserisci la tua email"/> <input type="text" value="Inserisci la tua password"/> <input type="button" value="Accedi"/> <input type="button" value="Registrati"/> <input type="button" value="Recupera password"/>													
	<table border="1"> <thead> <tr> <th>Prodotto</th> <th>Descrizione</th> <th>Applicazione</th> <th>Download</th> <th>MB</th> <th>Contenuto</th> </tr> </thead> <tbody> <tr> <td></td> <td>SABDRAIN canali di drenaggio in pp</td> <td>Drenaggi Superficiali Gallerie Strade</td> <td></td> <td>63,89</td> <td>n.1 file .RTE n.1 file .JFC n.1 file .PDF n.1 file .XLSX</td> </tr> </tbody> </table>	Prodotto	Descrizione	Applicazione	Download	MB	Contenuto		SABDRAIN canali di drenaggio in pp	Drenaggi Superficiali Gallerie Strade		63,89	n.1 file .RTE n.1 file .JFC n.1 file .PDF n.1 file .XLSX
	Prodotto	Descrizione	Applicazione	Download	MB	Contenuto							
	SABDRAIN canali di drenaggio in pp	Drenaggi Superficiali Gallerie Strade		63,89	n.1 file .RTE n.1 file .JFC n.1 file .PDF n.1 file .XLSX								



Condizioni generali di vendita
Sale conditions
Conditions générales de vente
Condiciones generales de venta
www.sabspa.com

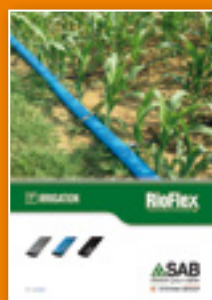
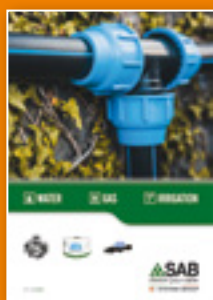

SAB S.p.A.
via Salvo D'Acquisto
61048 Sant'Angelo in Vado (PU)
ITALY
tel. +39 0722 810 800
fax +39 0722 810 158
sab@tubi.net
www.sabspa.com

Società soggetta a direzione e coordinamento da parte di HB Boscarini S.p.A.



**BILANCIO DI
SOSTENIBILITÀ
SUSTAINABILITY
REPORT**

