



07.21



# CATALOGO QUADRI ELETTRICI

CONTROL PANELS CATALOGUE  
CATALOGUE DE COFFRETS ÉLECTRIQUES

# Dinamica & Sportiva

Dynamic & Sports-minded

Dynamique & Sportif



## PASSIONE PER LE SFIDE

Da sempre i prodotti e i marchi **FOURGROUP** rappresentano una continua sfida nel mercato economico produttivo internazionale: tale impegno é rappresentato anche nel mondo dello Sport, dove l'azienda è protagonista appoggiando un giovane ed importante team!

## PASSION FOR CHALLENGES

**FOURGROUP** products and brands have always represented a continuous challenge in the international manufacturing market: this commitment is also represented in sport, where company supports one young but leading team!

## LA PASSION DES DÉFIS

Les produits et les marques **FOURGROUP** représentent depuis toujours un défi constant sur le marché international de la production: cet engagement se retrouve aussi dans le monde du sport puisque la société soutient une équipe jeune et importante!



## CHI SIAMO

**FOURGROUP** è una delle società leader nel mercato per la progettazione e costruzione di apparecchiature elettriche, meccaniche ed idrauliche. La produzione si focalizza su standard di alta qualità e design.

I prodotti di riferimento sono una gamma completa di quadri elettrici per pompe e motori, gruppi elettrogeni fino a 1,8MW, soccorritori anti-blackout, sistemi di pompaggio acqua ad uso civile ed industriale, gruppi e sistemi antincendio costruiti secondo EN12845 e UNI11292.

Soluzioni all'avanguardia, costante ricerca di nuovi standard qualitativi dei propri prodotti, attenzione alle esigenze del cliente e allo sviluppo di apparecchiature personalizzate, fanno di Fourgroup una delle aziende più innovative ed un punto di riferimento nel panorama internazionale.

## ABOUT US

**FOURGROUP** is one of the leading companies in the market for the design and construction of electrical, mechanical and hydraulic equipments. The production focuses on high quality and design standards.

The reference products are a complete range of electrical control panels for pumps and motors, generator sets up to 1,8MW, anti-blackout systems, water booster sets for civil and industrial use, fire fighting pumps and systems built according to the EN12845 European Standard.

Cutting-edge solutions, constant research into new quality standards for its products, attention to customer needs and the development of customised equipment, make Fourgroup one of the most innovative companies and a reference point on the international scene.

## QUI SOMMES-NOUS

**FOURGROUP** est l'une des principales entreprises sur le marché de la conception et de la construction d'équipements électriques, mécaniques et hydrauliques. La production est axée sur des normes de qualité et de conception élevées.

Les produits de référence sont une gamme complète de panneaux électriques pour pompes et moteurs, des groupes électrogènes jusqu'à 1,8MW, des systèmes de secours anti-blackout, des systèmes de pompage d'eau à usage civil et industriel, des groupes et des systèmes de lutte contre l'incendie construits selon la Norme Européenne EN12845.

Des solutions d'avant-garde, la recherche constante de nouvelles normes de qualité pour ses produits, l'attention portée aux besoins des clients et le développement d'équipements personnalisés font de Fourgroup l'une des entreprises les plus innovantes et un point de référence sur la scène internationale.



REALIZZAZIONI SPECIALI / SPECIAL REALIZATIONS / RÉALISATIONS SPÉCIALES



Quadro per pompe gasolio  
Control panel for diesel pumps  
Coffret pour pompes gasoil



Quadro antideflagrante  
Explosion proof control panel  
Coffret antidéflagrant



Quadro standard con optional aggiunti  
Control panels with added optional  
Coffrets de controle avec options supplémentaires

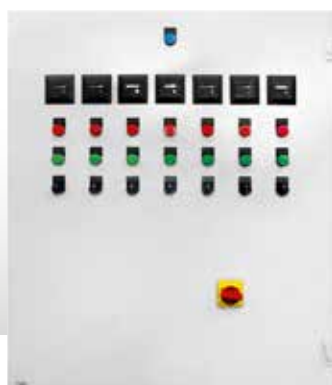

Quadro multiutenza  
Multi-consumption control panel  
Coffret de distribution multifonctions



Quadro impianto trattamento acque  
Control panel for water treatment systems  
Coffret de l'installation de traitement des eaux



Quadro per pompe sommergibili  
Control panel for submersible pumps  
Coffret pour pompes submersible



**Realizzazioni speciali su specifiche esigenze del cliente**  
Production of special panels according to client specification and need  
Réalisations spéciales sur exigences spécifiques du client



## ” *Progettazione e realizzazione quadri elettrici personalizzati!*

*Design and construction custom control panels!*

*Conception et construction coffrets électriques personnalisés!*

### PROGETTI PERSONALIZZATI

Uno staff di tecnici altamente specializzati è sempre a disposizione per studiare soluzioni su specifica del cliente per ogni tipo di applicazione.

**Ogni quadro elettrico è progettato e dimensionato in base al tipo di esigenza e di impianto.**

### CUSTOMIZED PROJECTS

A staff of highly specialized technicians is always available to study solutions to customer specifications for each type of application.

**Each control panel is designed and sized according to the type of requirement and system.**

### PROJETS PERSONNALISÉS

Une équipe de techniciens spécialisé formés est toujours disponible pour étudier les solutions aux spécifications du client pour chaque type d'application.

**Chaque coffret électrique est conçu et dimensionné en fonction du type d'exigence et système.**

### PRINCIPALI SETTORI

- Agricolo / Allevamento / Depurazione
- Civile / Industriale / Terziario
- Navale / Sicurezza
- Antincendio / Emergenza

### MAIN SECTOR

- Agricultural / Breeding / Sewage
- Civil / Industrial / Tertiary
- Naval / Safety
- Fire / Emergency

### PRINCIPAUX DOMAINES

- Agricole / Élevage / Égout
- Civil / Industrielle / Tertiaire
- Naval / Sécurité
- Incendie / Urgence



## DEFINIZIONE DI QUADRO ELETTRICO

Un quadro elettrico è una parte di un impianto elettrico, a valle del contatore, con la funzione di alimentare e, nell'eventualità di un guasto o in caso di manutenzione, di scollegare elettricamente uno o più motori ad esso connessa. I quadri possono essere di tipo industriale o domestico, ma hanno le stesse funzioni, con caratteristiche ovviamente adeguate allo scopo.

Esistono diverse tipologie di quadri elettrici, costruite in base alle necessità, Fourgroup propone principalmente 2 categorie.

## CONTROL PANELS DEFINITION

An electrical panel is part of an electrical system, downline of the counter, with the function of powering and, in the event of a fault or for maintenance purposes, disconnecting power from one or more connected motors. Panels can be designed for industrial or residential applications, but have the same functions, obviously with characteristics adapted to the assigned purpose.

There are various types of electrical panel, constructed according to specific requirements. Fourgroup offers mainly 2 categories.

## DÉFINITION DES COFFRET ÉLECTRIQUE

Un coffret électrique est une partie d'une installation électrique, en aval du contacteur, dont la fonction est d'alimenter et, en cas de panne éventuelle ou de maintenance, de débrancher électriquement un ou plusieurs moteurs raccordés à ce coffret. Qu'ils soient de type industriel ou résidentiel, ils ont les mêmes fonctions et présentent évidemment des caractéristiques adaptées à l'usage prévu.

Il existe différents types de coffrets électriques, construits en fonction des besoins. Fourgroup propose 2 catégories de coffrets.



### Elettronici

costituiti principalmente da una scheda elettronica che esegue tutte le funzioni, regolazioni, protezioni e gestisce il carico/i applicato. I modelli si suddividono inoltre in base al numero di motori (1, 2 o 3 motori).



### Electronic

mainly comprising an electronic board that performs all functions, settings and protections to manage the applied load/s. The models are divided further according to the number of motors (1, 2 or 3 motors).



### Electronic

constitués d'une carte électronique qui exécute tous les réglages, fonctions, protections et gère la charge/les charges appliquée/s. Ces modèles diffèrent selon le nombre de moteurs à alimenter (1, 2 ou 3 moteurs).



### Elettromeccanici

costituiti da diversi componenti elettrici tra cui relè, contattori, selettori ecc.



### Electromechanical

comprising various electrical components, including relays, contactors, selectors etc.



### Electromechanical

constitués de composants électriques, tels que les relais, contacteurs, sélecteurs, etc.

I modelli possono essere suddivisi per uno o più carichi e sono configurabili in fase d'ordine su specifica del cliente con diversi optional. I modelli a catalogo comprendono da 1 a N motori con diverse tipologie di avviamento (diretto, stella-triangolo, reattanza, inverter di frequenza, soft-start ecc.).

Models can be divided by one or more loads and can be configured when ordering, to meet client specifications, with various optionals as required. The catalogue models include from 1 to N motors with different start-up types (direct, star-delta, self-induction, frequency converter, soft-start etc.).

Les modèles peuvent être conçus pour une ou plusieurs charges et peuvent être configurés au moment de la commande, selon les spécifications du client, avec différents option. Les modèles dans le catalogue fonctionnent avec 1 à N moteurs avec différents types de démarrage (direct, étoile-triangle, réactance, convertis. de fréq., démarrage progres., etc.).



## COME SCEGLIERE UN QUADRO ELETTRICO

Bisogna conoscere quale sarà l'uso del quadro elettrico per determinarne il giusto modello in grado di sopportare alla richiesta. Il tipo di quadro necessario dipende dall'utilizzo a cui è destinato, dal luogo di installazione, dal grado di protezione minimo e dalla temperatura di utilizzo.

Per identificare il tipo di quadro elettrico più adatto alle proprie esigenze, bisognerà formulare una serie di domande al richiedente per fornire tutte le informazioni necessarie su dimensionamenti, optional e costi.

### Per la scelta del quadro elettrico bisogna rispondere ad alcune domande:

- Quale tipo di carico andrà collegato al quadro elettrico (pompa, motore ecc.)
- Potenza del carico applicato al quadro elettrico (kw o hp e corrente nominale)
- Motore monofase o trifase
- Tipologia funzionamento (acque chiare, nere, sollevamento, pressurizzazione ecc.)
- Tipo avviamento (D.O.L., Y-D, inverter ecc.)
- Quantità carichi applicati (1,2,3 ecc.)
- Particolari costruttivi (box metallico o plastico o inox, doppia porta ipxx, ecc.)
- Optional necessari (uscite allarmi, scambio motori, scaricatori, centraline, ecc.)
- Normative (antincendio, atex, ecc.)

In generale per la scelta corretta del quadro elettrico è bene avere il maggior numero di informazioni possibili dal cliente sul tipo di impianto e sul funzionamento per offrire il quadro adeguato.

## HOW TO CHOOSE A CONTROL PANEL

The user first needs to establish the intended use of the electrical panel to enable selection. The type of panel required depends on the intended use, the place of installation and minimum protection rating and the temperature of use.

To identify the type of electrical panel most suited to your needs, a series of questions should be formulated for the client, to provide all necessary information on sizing, optionals and costs.

### To select your electrical panel, first answer a number of questions:

- What type of load will the electrical panel be connected to (pump, motor etc.)
- Power of load applied to the electrical panel (kw or hp and nominal current)
- Single phase or three phase motor
- Operation type (clean water, waste water, lifting, pressurisation, etc.)
- Start-up type (D.O.L., Y-D, converter etc.)
- Quantity of loads applied (1,2,3 etc.)
- Construction details (metal, plastic or st. steel enclosure, double door ipxx, etc.)
- Optionals required (alarm outputs, motor exchange, drains, control units, etc.)
- Reference (fire protect., anti-explosion, etc.)

In general the correct selection of the electrical panel would need the most amount of information possible from the client on the type of system where it is to be installed and on the relevant operating modes in order to offer the ideal panel.

## COMMENT CHOISIR UN COFFRET ÉLECTRIQUE

Il faut tout d'abord savoir à quel usage est destiné le coffret électrique pour déterminer le modèle adéquat. Le type de coffret à choisir dépend de l'usage prévu, du lieu d'installation, du degré de protection minimal et de la température de service.

Pour identifier le type de coffret électrique le mieux adapté à ses exigences, il faudra adresser une série de questions au demandeur pour pouvoir fournir toutes les informations nécessaires sur les dimensions, les accessoires en option et les coûts.

### Pour le choix du coffret électrique, il faut répondre à quelques questions:

- Quel type de dispositif sera branché au coffret électrique (pompe, moteur, etc.)
- Puissance charge appliquée au coffret électrique (kw ou hp et courant nominal)
- Moteur monophasé ou triphasé
- Type fonctionnement (eaux claires, eaux usées, levage, surpression, etc.)
- Type démarrage (D.O.L., Y-D, convertiss. etc.)
- Nombre charges raccordées (1, 2, 3, etc.)
- Détails de construction (boîtier métallique, plastique ou inox, double porte ipxx, etc.)
- Option nécessaires (sorties alarm., échange moteurs, parasurtenseurs, centrales, etc.)
- Règlements (anti-incendie, atex, etc.)

De manière générale, pour choisir correctement un coffret électrique et fournir au client le modèle adéquat, il est important de disposer du plus grand nombre d'informations possibles sur le type d'installation et sur le fonctionnement.



SISTEMA STAR / STAR SYSTEM / SYSTÈME STAR



” **La gestione dei tuoi impianti sempre a portata di mano!**

*The control of your installations always in your hands!*

*La gestion de vos installations toujours à portée de main!*



APP disponibile per  
APP available for  
APP disponible pour



residenziale  
residential / résidentiel



commerciale  
commercial / commercial



pubblico  
public / public



industriale  
industrial / industriel



agricolo  
agricultural / agricole



# SISTEMA STAR / STAR SYSTEM / SYSTÈME STAR



## GENERALI

- Multilingua e password (Star-D / 2D)
- Ritardo protezioni
- Frequenza 50-60Hz
- Alternanze/contemporaneità avviamenti
- Esclusione e ritardi motori
- Impostazioni da APP

## GENERAL

- Multi language and password (Star-D / 2D)
- Protections delay
- 50-60Hz frequency
- Alternations/simultaneous start-up
- Motor exclusion and delay
- Settings via APP

## GÉNÉRAL

- Multilingue et password (Star-D / 2D)
- Retard protections
- Fréquence 50-60 Hz
- Alternances/simultanéité démarrages
- Exclusion et retards des moteurs
- Réglages à partir du APP



## VANTAGGI

- Multiuso
- Controllo remoto
- Multi potenza
- Massime protezioni
- Display (Star-D / 2D)
- Gestione con APP (optional)
- Avvisi in tempo reale
- Ingresso 4÷20mA 12V (optional)
- Ingressi pressostati/galleggianti/sonde di livello
- ModBus (optional)

## BENEFITS

- Multi-use
- Remote control
- Multi-power
- Maximum level protections
- Display (Star-D / 2D)
- Management via APP (optional)
- Real time information
- 4÷20mA 12V input (optional)
- Pressure switch/float switch/level probe input
- ModBus (optional)

## AVANTAGES

- Multi-usages
- Commande à distance
- Multi-puissance
- Protections maximales
- Écran (Star-D / 2D)
- Gestion avec APP (optionnel)
- Avertissements en temps réel
- Entrée 4÷20mA 12V (optionnel)
- Entrées pressostats/flotteurs/sondes de niveau
- ModBus (optionnel)



## VISUALIZZAZIONI (STAR-D / STAR-2D)

- Tensione (V) / Frequenza (Hz)
- Assorbimento motori (A)
- CosØ/conta impulsi/conta ore
- Pressione (bar)/livello acqua (cm)
- Storico anomalie (da APP)

## DISPLAY VIEWS (STAR-D / STAR-2D)

- Voltage (V) / Frequency (Hz)
- Motor absorption(A)
- CosØ/pulse counter/running hours
- Pressure (bar)/water level (cm)
- Anomalies history (by APP)

## AFFICHAGES (STAR-D / STAR-2D)

- Tension (V) / Fréquence (Hz)
- Absorption moteurs (A)
- CosØ/compteur impulsions/compt. horaire
- Pression (bars)/niveau d'eau (cm)
- Historique des anomalies (avec APP)

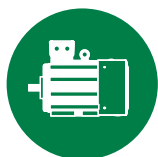

## IMPOSTAZIONE MOTORI

- Auto-apprendimento dati motori
- Min-max corrente (A)
- Ritardo avviamento/arresto (da APP)
- Alternanza motori (Star-D / 2D)

## MOTOR SETUP

- Self-learning of motor data
- Min-max current (A)
- Start/stop delay setting
- Alternated start-up (Star-D / 2D)

## RÉGLAGE MOTEURS

- Autoapprentissage données du moteurs
- Courant min-max (A)
- Retard démarrage/arrêt
- Démarrage alterné (Star-D / 2D)



## ALLARMI E PROTEZIONI

- Min-max livello acqua
- Min-max tensione
- Anomalia fasi/frequenza
- Min-max corrente/cosØ motori
- Intervento klixon motori
- Max avviamenti ora
- Max funzionamento continuo
- Acqua in camera olio (Star 2 e 2D)

## ALARMS & PROTECTIONS

- Min-max water level
- Min-max voltage
- Phase/frequency error
- Motors min-max current/cosØ
- Motors klixon trip
- Max start-ups per hours
- Max continuous operation
- Water in oil chamber (Star-D / 2D)

## ALARMES ET PROTECTIONS

- Niveau d'eau min-max
- Tension min-max
- Anomalie phases/fréquence
- Courant min-max/cosØ moteurs
- Intervention klixon moteurs
- Démarrages heure
- Fonctionnement continu max
- Eau dans chambre de l'huile (Star-D / 2D)



## VANTAGGI DELL'APP

- Gestire l'impianto con uno smartphone
- Gestire l'impianto con un tablet
- Accendere/spegnere i motori da remoto
- Ricevere qualsiasi tipo di allarme (anomalia motori, livelli, ecc...)
- Modificare logiche di funzionamento
- Modificare soglie di intervento protezioni
- Gestione contemporanea molteplici impianti

## APP BENEFITS

- Manage the system on your smartphone
- Manage the system using a tablet
- Start-up/shut down the motor remotely
- Receive any type of alarm (motors faults, levels, etc.)
- Modify operating logic
- Modify safety device trip thresholds
- Simultaneously manage different systems

## AVANTAGES DU APP

- Gérer l'installation avec un smartphone
- Gérer l'installation avec une tablette
- Mettre tension/hors moteurs à distance
- Recevoir n'importe quel type d'alarme (anomalies moteurs, niveaux, etc.)
- Modifier les logiques de fonctionnement
- Modifier seuils d'intervention protections
- Gérer simultanément de nombreuses installations

# STAR

Nuova generazione di quadri elettronici per 1 motore monofase/trifase con gestione WiFi e APP per Android, iOS e Windows  
 New generation of electronic panels for 1 single-phase/three-phase motor with WiFi and APP management for Android, iOS and Windows  
 Nouvelle génération de panneaux électroniques pour 1 moteur monophasés/triphasés avec gestion WiFi et APP pour Android, iOS et Windows

0,37 → 15 kW



APP disponibile per  
APP available for  
APP disponible pour



## SERIE STAR

- Sezionatore generale con bloccaporta
- Fusibili di protezione
- Pulsanti AUTO-0-MAN
- Spie LED rete, auto, marcia
- Spie LED allarme livello, sovraccarico motore
- Ingresso autoconfigurabile galleggiante/pressostato/sonde per comando motore
- Ingresso autoconfigurabile galleggiante/pressostato/sonde per allarme
- Ingresso autoconfigurabile galleggiante/pressostato/sonde per min livello
- Selettore riempimento/svuotamento
- Regolatore sensibilità sonde
- Uscita motore: Relè(monofase)/Contattore(trifase)
- Protezione motore da sovraccarico regolabile
- Tempo di intervento protezione 5"
- Uscita allarme ottico/acustico 12V 100mA
- Uscita allarme (contatti puliti NC-C-NA)
- Ingresso klixon motore con spia di segnalazione
- Predisposizione per condensatore di marcia
- Agevoli connessioni con morsettiere estraibili
- Protezione da marcia a secco per minima corrente regolabile
- Auto-apprendimento dati motore
- Controllo min-max tensione di alimentazione
- Controllo mancanza-sequenza fasi tensione di alimentazione (solo versione trifase)
- Predisposizione moduli WiFi, 4÷20mA (misura pressione/livello/portata), ModBus opzionali

## STAR SERIES

- Main switch with door lock
- Protection fuses
- AUTO-0-MAN buttons
- LED lights for network, automatic, running
- LED level warning lights, motor overload
- Self-configurable float/pressure switch/probe input for motor control
- Self-configurable input float/pressure switch/probes for alarm
- Self-configurable input float/pressure switch/probes for min level
- Fill/empty selector
- Probe sensitivity regulator
- Motor output: Relay(single ph.)/Contactor(three ph.)
- Adjustable overload motor protection
- Protection intervention time 5"
- 12V 100mA optical/acoustic alarm output
- Alarm output (dry contacts NC-C-NA)
- Motor klixon input with signal light
- Ready for running capacitor
- Easy connections with removable terminal blocks
- Dry running protection for minimum current, adjustable
- Motor data self-learning
- Control of min-max supply voltage
- Lack voltage phase sequence check power supply (three-phase version only)
- WiFi modules predisposition, 4÷20mA (measure pressure/level/flow rate), optional ModBus

## SÉRIE STAR

- Interrupteur principal avec serrure de porte
- Fusibles de protection
- Boutons AUTO-0-MAN
- Lumières LED pour réseau, automatique, exécution
- Voyants lumin. de niveau LED, surcharge moteur
- Entrée flotteur/pressostat/sonde auto-configurable pour la commande du moteur
- Flotteur d'entrée/interrupteur de pression/sondes auto-configurables pour alarme
- Flotteur d'entrée auto-configurable/pressostat/sondes pour niveau minimum
- Sélecteur de remplissage/vide
- Régulateur de sensibilité de sonde
- Sortie moteur: Relais(monoph.)/Contacteur(triph.)
- Protection réglable du moteur de surcharge
- Temps d'intervention de protection 5"
- Sortie d'alarme optique/acoustique 12V 100mA
- Sortie d'alarme (contacts secs NC-C-NA)
- Entrée klixon moteur avec signal lumineux
- Condensateur prêt à fonctionner
- Connexions faciles avec des borniers amovibles
- Protection contre le fonctionnement à sec pour un minimum courant, réglable
- Auto-apprentissage des données motrices
- Contrôle de la tension d'alimentation min-max
- Contrôle de séquence de phase de manque de tension alimentation (vers. triphasée uniquement)
- Predisposition des modules WiFi, 4÷20mA (mesure pression/niveau/débit), ModBus en option

# STAR



## APPLICAZIONI TIPICHE / STANDARD APPLICATIONS / APPLICATIONS TYPIQUES

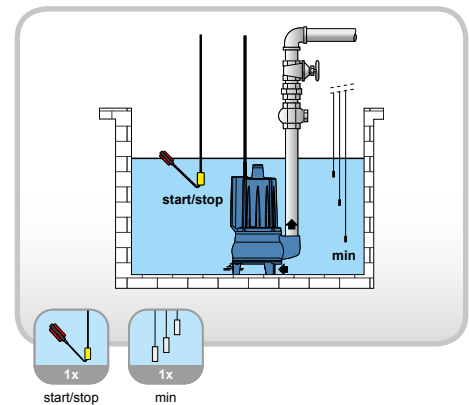
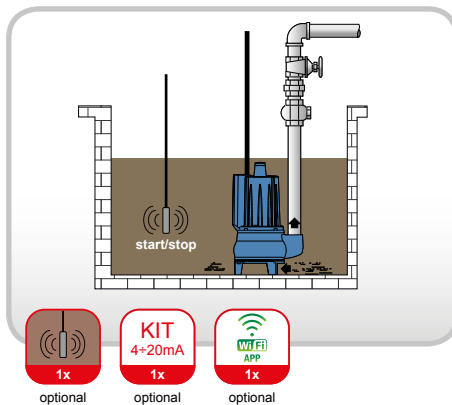
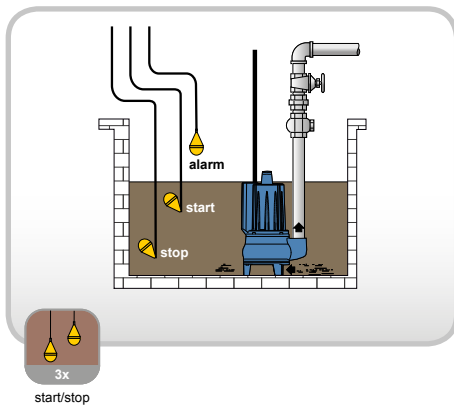
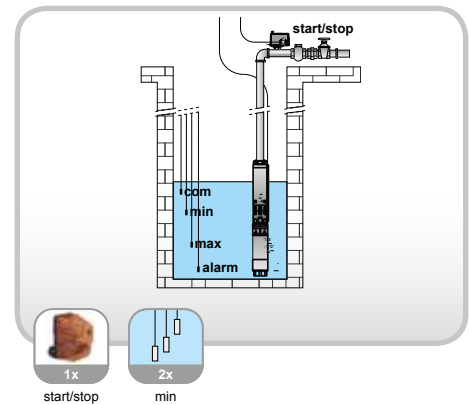
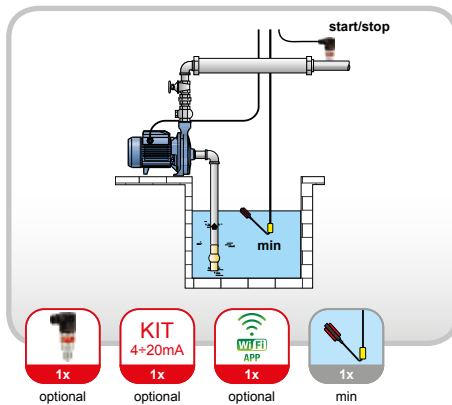
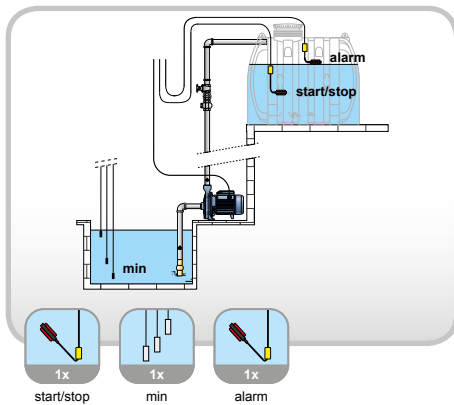

**1** **Quadro elettrico per n.1 motore**  
Control panel for n.1 motor  
Coffret électronique pour n.1 moteur

V	COD.	MODELLO / MODEL	POTENZA / POWER		CORRENTE / CURRENT	L x W x H			kg	box	
			kW	Hp		H mm	L mm	W mm			
50/60 Hz					Nx [range] A						
1~230V	013.20	STAR-M/3	0,37÷2,2	0,5÷3	1x [2÷16]	340	240	170	1,9	ABS	
	3~400V	013.23	STAR-T/10	0,55÷7,5	0,75÷10	1x [2÷15]	340	240	170	2,4	ABS
		013.24	STAR-T/15	7,5÷11	10÷15	1x [16÷24]	340	240	170	2,6	ABS
	013.30	STAR-T/20	7,5÷15	10÷20	1x [16÷32]	340	240	170	2,7	ABS	
OPTIONAL	013.90	KIT WI-FI	Modulo Wi-fi per App		Wi-fi module for App	Module Wi-fi pour application					
	013.91	KIT 4-20mA	Modulo sensore 4÷20mA per misura pressione/livello/portata		4÷20mA sensor module for pressure/level/flow measurement	Module capteur 4÷20mA pour la mesure de pression/niveau/débit					
	013.92	KIT-BAT	Batteria di backup		Backup battery	Batterie de secours					
	013.93	KIT MODBUS	Connettore per interfaccia Modbus		Connector for Modbus interface	Connecteur pour interface Modbus					

# STAR-2

Nuova generazione di quadri elettronici per 2 motori monofase/trifase con gestione WiFi e APP per Android, iOS e Windows  
 New generation of electronic panels for 2 single-phase/three-phase motors with WiFi and APP management for Android, iOS and Windows  
 Nouvelle génération de panneaux électroniques pour 2 moteurs monophasés/triphasés avec gestion WiFi et APP pour Android, iOS et Windows

0,37 → 15 kW



APP disponibile per  
APP available for  
APP disponible pour



## SERIE STAR-2

- Sezionatore generale con bloccaporta
- Fusibili di protezione
- Pulsanti AUTO-0-MAN
- Spie LED rete, auto, marcia
- Spie LED allarme livello, sovraccarico motore
- 2 ingressi autoconfigurabili galleggiante/pressostato/sonde per comando motori
- Ingresso autoconfigurabile galleggiante/pressostato/sonde per allarme
- Ingresso autoconfigurabile galleggiante/pressostato/sonde per min livello
- Selettore riempimento/svuotamento
- Regolatore sensibilità sonda
- Uscita motore: Relè(monofase)/Contattore(trifase)
- Protezione motore da sovraccarico regolabile
- Tempo di intervento protezione 5"
- Uscita allarme ottico/acustico 12V 100mA
- 2 uscite allarme (contatti puliti NC-C-NA)
- Ingresso klixon motore con spia di segnalazione
- Predisposizione per condensatore di marcia
- Agevoli connessioni con morsettiere estraibili
- Protezione da marcia a secco per minima corrente regolabile
- Auto-apprendimento dati motore
- Controllo min-max tensione di alimentazione
- Controllo mancanza-sequenza fasi tensione di alimentazione (solo versione trifase)
- Predisposizione moduli WiFi, 4÷20mA (misura pressione/livello/portata), ModBus opzionali
- Alternanza motori escludibile

## STAR-2 SERIES

- Main switch with door lock
- Protection fuses
- AUTO-0-MAN buttons
- LED lights for network, automatic, running
- LED level warning lights, motor overload
- 2 self-configurable float/pressure switch/probe inputs for motors control
- Self-configurable input float/pressure switch/probes for alarm
- Self-configurable input float/pressure switch/probes for min level
- Fill/empty selector
- Probe sensitivity regulator
- Motor output: Relay(single ph.)/Contactor(three ph.)
- Adjustable overload motor protection
- Protection intervention time 5"
- 12V 100mA optical/acoustic alarm output
- 2 alarm outputs (dry contacts NC-C-NA)
- Motor klixon input with signal light
- Ready for running capacitor
- Easy connections with removable terminal blocks
- Dry running protection for minimum current, adjustable
- Motor data self-learning
- Control of min-max supply voltage
- Lack voltage phase sequence check power supply (three-phase version only)
- WiFi modules predisposition, 4÷20mA (measure pressure/level/flow rate), optional ModBus
- Alternated start-up excludable

## SÉRIE STAR-2

- Interrupteur principal avec serrure de porte
- Fusibles de protection
- Boutons AUTO-0-MAN
- Lumières LED pour réseau, automatique, exécution
- Voyants lumin. de niveau LED, surcharge moteur
- 2 entrées flotteur/pressostat/sonde auto-configurable pour la commande du moteurs
- Flotteur d'entrée/interrupteur de pression/sondes auto-configurables pour alarme
- Flotteur d'entrée auto-configurable/pressostat/sondes pour niveau minimum
- Sélecteur de remplissage/vider
- Régulateur de sensibilité de sonde
- Sortie moteur: Relais(monoph.)/Contacteur(triph.)
- Protection réglable du moteur de surcharge
- Temps d'intervention de protection 5"
- Sortie d'alarme optique/acoustique 12V 100mA
- 2 sorties d'alarme (contacts secs NC-C-NA)
- Entrée klixon moteur avec signal lumineux
- Condensateur prêt à fonctionner
- Connexions faciles avec des borniers amovibles
- Protection contre le fonctionnement à sec pour un minimum courant, réglable
- Auto-apprentissage des données motrices
- Contrôle de la tension d'alimentation min-max
- Contrôle de séquence de phase de manque de tension alimentation (vers. triphasée uniquement)
- Predisposition des modules WiFi, 4÷20mA (mesure pression/niveau/débit), ModBus en option
- Possibilité d'exclusion des l'échange moteurs

# STAR-2



## APPLICAZIONI TIPICHE / STANDARD APPLICATIONS / APPLICATIONS TYPIQUES

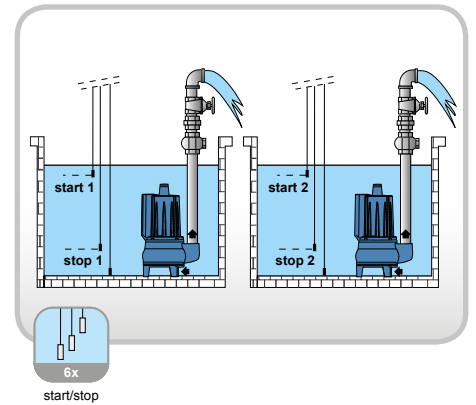
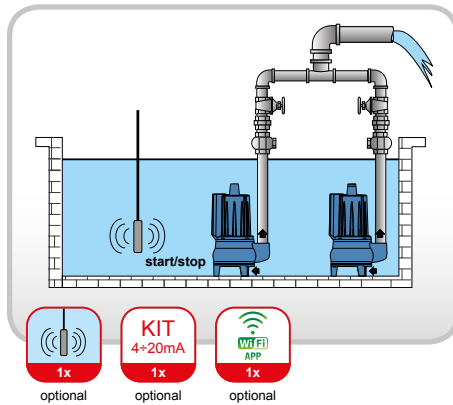
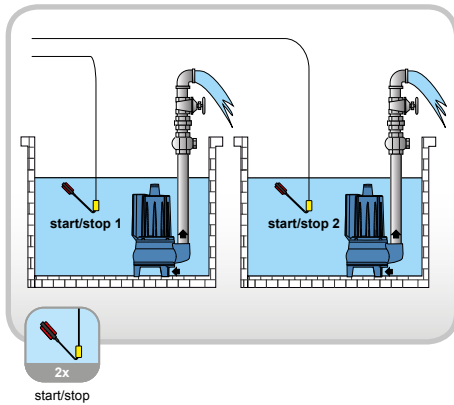
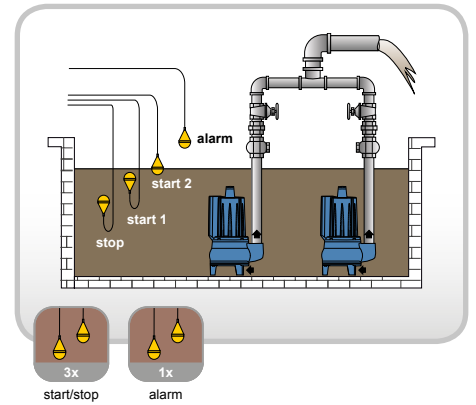
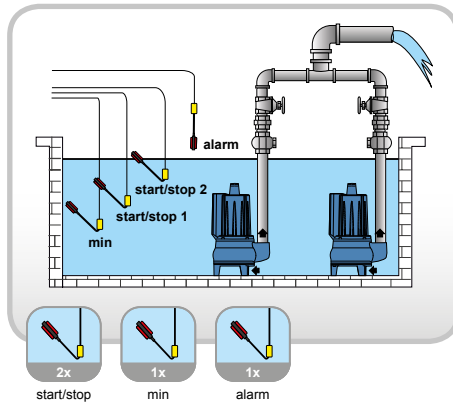
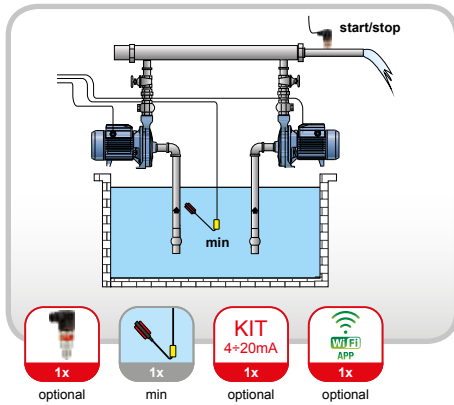

**Quadro elettrico per n.2 motori**  
Control panel for n.2 motors  
Coffret électronique pour n.2 moteurs



V	COD.	MODELLO / MODEL	POTENZA / POWER		CORRENTE / CURRENT	L x W x H			kg	box	
			kW	Hp		H mm	L mm	W mm			
50/60 Hz					Nx [range] A						
1~230V	013.25	STAR 2-M/3	0,37÷2,2	0,5÷3	2x [2÷16]	340	240	170	1,9	ABS	
	3~400V	013.28	STAR 2-T/10	0,55÷7,5	0,75÷10	2x [2÷15]	340	240	170	2,4	ABS
		013.29	STAR 2-T/15	7,5÷11	10÷15	2x [16÷24]	340	240	170	2,6	ABS
	013.31	STAR 2-T/20	7,5÷15	10÷20	2x [16÷32]	340	240	170	2,7	ABS	
OPTIONAL	013.90	KIT WI-FI	Modulo Wi-fi per App		Wi-fi module for App	Module Wi-fi pour application					
	013.91	KIT 4-20mA	Modulo sensore 4÷20mA per misura pressione/livello/portata		4÷20mA sensor module for pressure/level/flow measurement	Module capteur 4÷20mA pour la mesure de pression/niveau/débit					
	013.92	KIT-BAT	Batteria di backup		Backup battery	Batterie de secours					
	013.93	KIT MODBUS	Connettore per interfaccia Modbus		Connector for Modbus interface	Connecteur pour interface Modbus					

# STAR-D

Nuova generazione di quadri elettronici per 1 motore monofase/trifase con display, WiFi e APP per Android, iOS e Windows  
 New generation of electronic panels for 1 single-phase/three-phase motor with display, WiFi and APP for Android, iOS and Windows  
 Nouvelle génération de panneaux électroniques pour 1 moteur monophasés/triphasés avec écran, WiFi et APP pour Android, iOS et Windows

0,37 → 15 kW



APP disponibile per  
APP available for  
APP disponible pour



## SERIE STAR-D

- Sezionatore generale con bloccaporta
- Fusibili di protezione
- Pulsanti AUTO-0-MAN
- Display grafico OLED con tasti di comando
- Visualizzazione tensione/corrente/allarmi
- Spie LED rete, auto, marcia
- Spie LED allarme livello, sovraccarico motore
- Ingressi autoconfigurabili galleggiante/pressostato/sonde per comando motore, allarme e min livello
- Selettore riempimento/svuotamento
- Regolatore sensibilità sonda
- Uscita motore: Relè(monofase)/Contattore(trifase)
- Protezione motore da sovraccarico regolabile
- Tempo di intervento protezione 5"
- Uscita allarme ottico/acustico 12V 100mA
- Uscita allarme (contatti puliti NC-C-NA)
- Ingresso klixon motore con spia di segnalazione
- Predisposizione per condensatore di marcia
- Agevoli connessioni con morsettiere estraibili
- Protezione da marcia a secco per minima corrente regolabile
- Auto-apprendimento dati motore
- Controllo min-max tensione di alimentazione
- Controllo mancanza-sequenza fasi tensione di alimentazione (solo versione trifase)
- Predisposizione moduli WiFi, 4÷20mA (misura pressione/livello/portata), ModBus opzionali

## STAR-D SERIES

- Main switch with door lock
- Protection fuses
- AUTO-0-MAN buttons
- OLED graphic display with control keys
- Voltage/current/alarm display
- LED lights for network, automatic, running
- LED level warning lights, motor overload
- Self-configurable float/pressure switch/probe inputs for motor control, alarm and min level
- Fill/empty selector
- Probe sensitivity regulator
- Motor output: Relay(single ph.)/Contactor(three ph.)
- Adjustable overload motor protection
- Protection intervention time 5"
- 12V 100mA optical/acoustic alarm output
- Alarm output (dry contacts NC-C-NA)
- Motor klixon input with signal light
- Ready for running capacitor
- Easy connections with removable terminal blocks
- Dry running protection for minimum current, adjustable
- Motor data self-learning
- Control of min-max supply voltage
- Lack voltage phase sequence check power supply (three-phase version only)
- WiFi modules predisposition, 4÷20mA (measure pressure/level/flow rate), optional ModBus

## SÉRIE STAR-D

- Interrupteur principal avec serrure de porte
- Fusibles de protection
- Boutons AUTO-0-MAN
- Affichage graphique OLED avec touches de commande
- Affichage de tension/courant/alarmes
- Lumières LED pour réseau, automatique, exécution
- Voyants lumin. de niveau LED, surcharge moteur
- Entrées flotteur/pressostat/sonde auto-configurable pour la commande du moteur, alarme et min niveau
- Sélecteur de remplissage/vide
- Régulateur de sensibilité de sonde
- Sortie moteur: Relais(monoph.)/Contacteur(triph.)
- Protection réglable du moteur de surcharge
- Temps d'intervention de protection 5"
- Sortie d'alarme optique/acoustique 12V 100mA
- Sortie d'alarme (contacts secs NC-C-NA)
- Entrée klixon moteur avec signal lumineux
- Condensateur prêt à fonctionner
- Connexions faciles avec des borniers amovibles
- Protection contre le fonctionnement à sec pour un minimum courant, réglable
- Auto-apprentissage des données motrices
- Contrôle de la tension d'alimentation min-max
- Contrôle de séquence de phase de manque de tension alimentation (vers. triphasée uniquement)
- Predisposition des modules WiFi, 4÷20mA (mesure pression/niveau/débit), ModBus en option

# STAR-D



## APPLICAZIONI TIPICHE / STANDARD APPLICATIONS / APPLICATIONS TYPIQUES

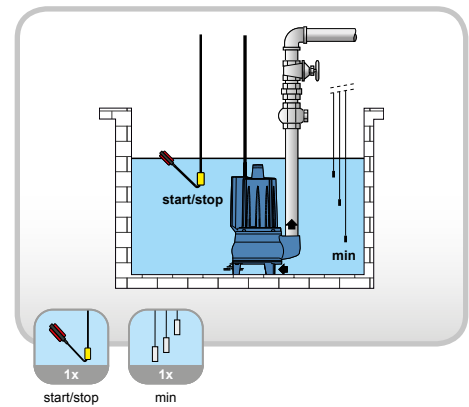
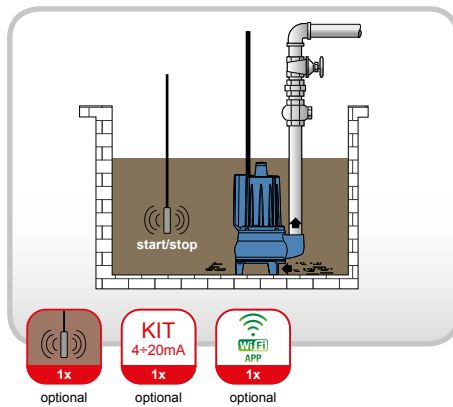
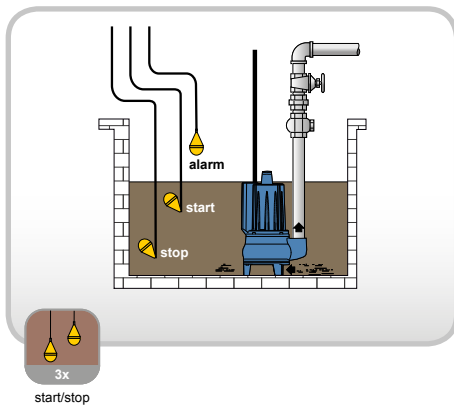
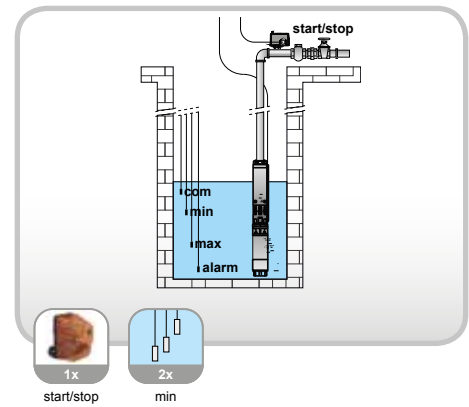
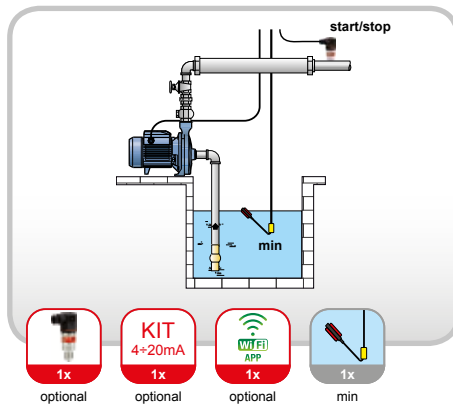
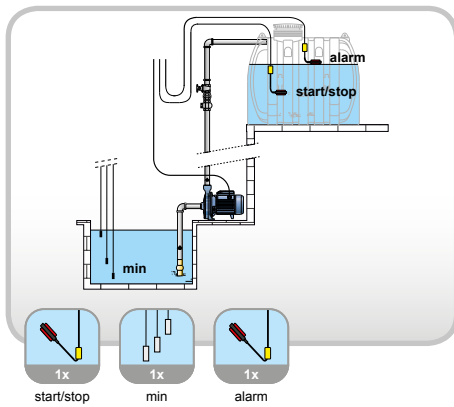

**Quadro elettrico per n.1 motore**  
Control panel for n.1 motor  
Coffret électronique pour n.1 moteur

V	COD.	MODELLO / MODEL	POTENZA / POWER		CORRENTE / CURRENT	L x W x H			kg	box	
			kW	Hp		H mm	L mm	W mm			
50/60 Hz					Nx [range] A						
1~230V	013.32	STAR D-M/3	0,37÷2,2	0,5÷3	1x [2÷16]	340	240	170	1,9	ABS	
	3~400V	013.33	STAR D-T/10	0,55÷7,5	0,75÷10	1x [2÷15]	340	240	170	2,4	ABS
		013.34	STAR D-T/15	7,5÷11	10÷15	1x [16÷24]	340	240	170	2,6	ABS
	013.35	STAR D-T/20	7,5÷15	10÷20	1x [16÷32]	340	240	170	2,7	ABS	
OPTIONAL	013.90	KIT WI-FI	Modulo Wi-fi per App		Wi-fi module for App	Module Wi-fi pour application					
	013.91	KIT 4-20mA	Modulo sensore 4÷20mA per misura pressione/livello/portata		4÷20mA sensor module for pressure/level/flow measurement	Module capteur 4÷20mA pour la mesure de pression/niveau/débit					
	013.92	KIT-BAT	Batteria di backup		Backup battery	Batterie de secours					
	013.93	KIT MODBUS	Connettore per interfaccia Modbus		Connector for Modbus interface	Connecteur pour interface Modbus					

# STAR-2D

Nuova generazione di quadri elettronici per 2 motori monofase/trifase con display, WiFi e APP per Android, iOS e Windows  
 New generation of electronic panels for 2 single-phase/three-phase motors with display, WiFi and APP for Android, iOS and Windows  
 Nouvelle génération de panneaux électroniques pour 2 moteurs monophasés/triphasés avec écran, WiFi et APP pour Android, iOS et Windows

0,37 → 15 kW



APP disponibile per  
APP available for  
APP disponible pour



## SERIE STAR-2D

- Sezionatore generale con bloccaporta
- Fusibili di protezione
- Pulsanti AUTO-0-MAN
- Display grafico OLED con tasti di comando
- Visualizzazione tensione/corrente/allarmi
- Spie LED rete, auto, marcia
- Spie LED allarme livello, sovraccarico motore
- Ingressi autoconfigurabili galleggiante/pressostato/sonde per comando motore, allarme e min livello
- Selettore riempimento/svuotamento
- Regolatore sensibilità sonda
- Uscita motore: Relè(monofase)/Contattore(trifase)
- Protezione motore da sovraccarico regolabile
- Tempo di intervento protezione 5"
- Uscita allarme ottico/acustico 12V 100mA
- 2 uscite allarme (contatti puliti NC-C-NA)
- Ingresso klixon motore con spia di segnalazione
- Predisposizione per condensatore di marcia
- Agevoli connessioni con morsettiere estraibili
- Protezione da marcia a secco per minima corrente regolabile
- Auto-apprendimento dati motore
- Controllo min-max tensione di alimentazione
- Controllo mancanza-sequenza fasi tensione di alimentazione (solo versione trifase)
- Predisposizione moduli WiFi, 4÷20mA (misura pressione/livello/portata), ModBus opzionali
- Alternanza motori escludibile

## STAR-2D SERIES

- Main switch with door lock
- Protection fuses
- AUTO-0-MAN buttons
- OLED graphic display with control keys
- Voltage/current/alarm display
- LED lights for network, automatic, running
- LED level warning lights, motor overload
- Self-configurable float/pressure switch/probe inputs for motor control, alarm and min level
- Fill/empty selector
- Probe sensitivity regulator
- Motor output: Relay(single ph.)/Contactor(three ph.)
- Adjustable overload motor protection
- Protection intervention time 5"
- 12V 100mA optical/acoustic alarm output
- 2 alarm outputs (dry contacts NC-C-NA)
- Motor klixon input with signal light
- Ready for running capacitor
- Easy connections with removable terminal blocks
- Dry running protection for minimum current, adjustable
- Motor data self-learning
- Control of min-max supply voltage
- Lack voltage phase sequence check power supply (three-phase version only)
- WiFi modules predisposition, 4÷20mA (measure pressure/level/flow rate), optional ModBus
- Alternated start-up excludable

## SÉRIE STAR-2D

- Interrupteur principal avec serrure de porte
- Fusibles de protection
- Boutons AUTO-0-MAN
- Affichage graphique OLED avec touches de commande
- Affichage de tension/courant/alarmes
- Lumières LED pour réseau, automatique, exécution
- Voyants lumin. de niveau LED, surcharge moteur
- Entrées flotteur/pressostat/sonde auto-configurable pour la commande du moteur, alarme et min niveau
- Sélecteur de remplissage/vide
- Régulateur de sensibilité de sonde
- Sortie moteur: Relais(monoph.)/Contacteur(triph.)
- Protection réglable du moteur de surcharge
- Temps d'intervention de protection 5"
- Sortie d'alarme optique/acoustique 12V 100mA
- 2 sorties d'alarme (contacts secs NC-C-NA)
- Entrée klixon moteur avec signal lumineux
- Condensateur prêt à fonctionner
- Connexions faciles avec des borniers amovibles
- Protection contre le fonctionnement à sec pour un minimum courant, réglable
- Auto-apprentissage des données motrices
- Contrôle de la tension d'alimentation min-max
- Contrôle de séquence de phase de manque de tension alimentation (vers. triphasée uniquement)
- Predisposition des modules WiFi, 4÷20mA (mesure pression/niveau/débit), ModBus en option
- Possibilité d'exclusion des l'échange moteurs



# STAR-2D



## APPLICAZIONI TIPICHE / STANDARD APPLICATIONS / APPLICATIONS TYPIQUES

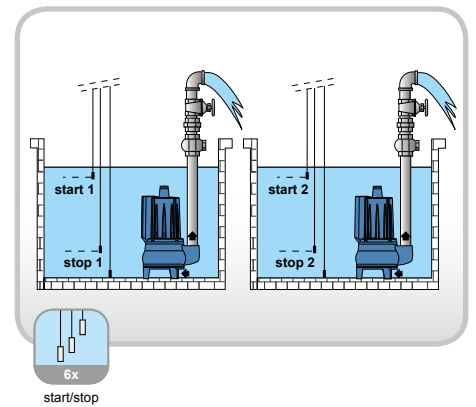
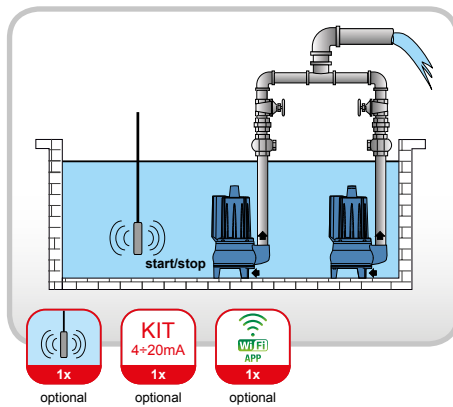
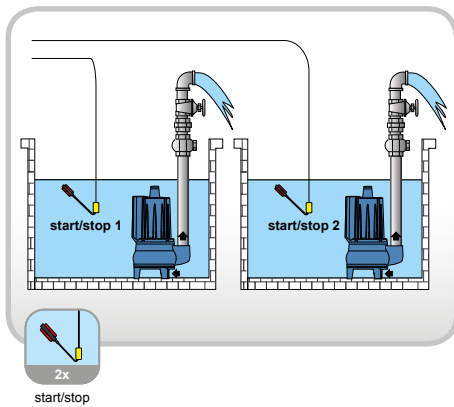
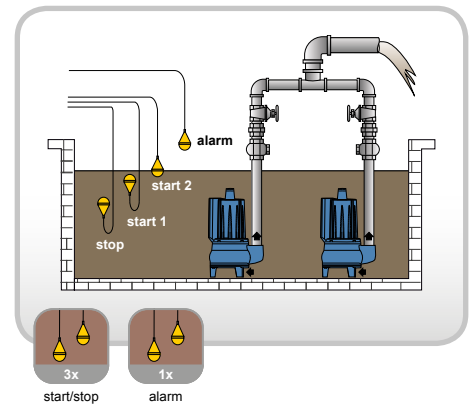
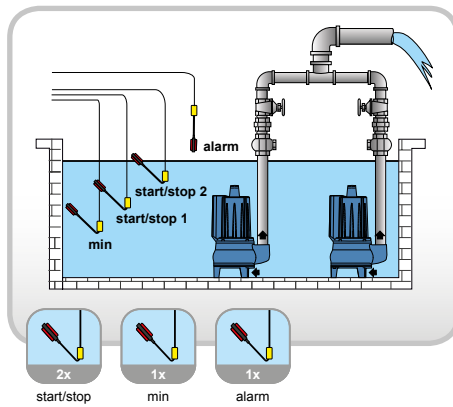
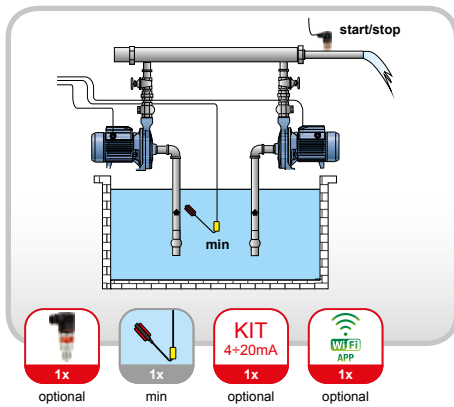

**Quadro elettrico per n.2 motori**  
Control panel for n.2 motors  
Coffret électronique pour n.2 moteurs



V	COD.	MODELLO / MODEL	POTENZA / POWER		CORRENTE / CURRENT	L x W x H			kg	box	
			kW	Hp		H mm	L mm	W mm			
50/60 Hz					Nx [range] A						
1~230V	013.36	STAR 2D-M/3	0,37÷2,2	0,5÷3	2x [2÷16]	340	240	170	1,9	ABS	
	3~400V	013.37	STAR 2D-T/10	0,55÷7,5	0,75÷10	2x [2÷15]	340	240	170	2,4	ABS
		013.38	STAR 2D-T/15	7,5÷11	10÷15	2x [16÷24]	340	240	170	2,6	ABS
	013.39	STAR 2D-T/20	7,5÷15	10÷20	2x [16÷32]	340	240	170	2,7	ABS	
OPTIONAL	013.90	KIT WI-FI	Modulo Wi-fi per App		Wi-fi module for App	Module Wi-fi pour application					
	013.91	KIT 4-20mA	Modulo sensore 4÷20mA per misura pressione/livello/portata		4÷20mA sensor module for pressure/level/flow measurement	Module capteur 4÷20mA pour la mesure de pression/niveau/débit					
	013.92	KIT-BAT	Batteria di backup		Backup battery	Batterie de secours					
	013.93	KIT MODBUS	Connettore per interfaccia Modbus		Connector for Modbus interface	Connecteur pour interface Modbus					

SISTEMA APP / APP SYSTEM / SYSTÈME APP



” **La gestione dei tuoi impianti sempre a portata di mano!**

*The control of your installations always in your hands!*

*La gestion de vos installations toujours à portée de main!*

cerca l'APP su Google play / search APP on Google play / rechercher l'APP sur Google play



residenziale  
residential / résidentiel



commerciale  
commercial / commercial



pubblico  
public / public



industriale  
industrial / industriel



agricolo  
agricultural / agricole

# SISTEMA APP / APP SYSTEM / SYSTÈME APP



## VISUALIZZAZIONI

- Tensione (V) / Frequenza (Hz)
- Assorbimento motori (A)
- CosØ/conta impulsi/conta ore
- Pressione (bar)/livello acqua (cm)
- Storico anomalie

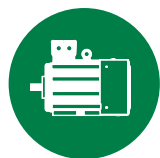

## IMPOSTAZIONE MOTORI

- Auto-apprendimento dati motori
- Min-max corrente (A) e min cosØ
- Ritardo avviamento/arresto
- Max funzionamento continuo
- Max avviamenti ora/minuto
- Max interventi Klixon
- Alternanza motori



## MODALITA' ALLARMI

- Modalità allarme sonoro e luminoso
- Allarmi da relè ritardabili
- Uscita allarme 12V



## ALLARMI E PROTEZIONI

- Min-max livello acqua
- Min-max tensione
- Anomalia fasi/frequenza
- Min-max corrente/cosØ motori
- Max interventi Klixon
- Acqua in camera olio
- Max avviamenti ora / minuto
- Max funzionamento continuo



## 4 PROGRAMMI DI COMANDO

### CLEAN

- Ingresso sonde o galleggiante min livello
- Ingresso pressostati/galleggianti/sonde
- Modalità svuotamento-riempimento
- Se presente ingresso sensore 4÷20mA
- Visualizzazione livello/allarme a display

### DARK

- Ingresso galleggianti di comando (normali o multicontact)
- Ingresso galleggiante max livello
- Autoritenuta
- Modalità svuotamento/riempimento
- Se presente ingresso sensore 4÷20mA
- Set pressioni-livelli di allarme a display

### DIGIT

- Ingresso sonde o galleggiante min livello
- Ingresso sensore pressione-liv. 4÷20mA
- Set pressioni-livelli avviamento/arresto/allarme motori

### MULTITANK

- Comando motori di impianti diversi
- Impostazione programma per ogni motore
- Motore 1 logiche: CLEAN, DARK, DIGIT
- Motore 2 (ed eventuale motore 3) logiche: CLEAN, DARK
- Se presente ingresso sensore 4÷20mA
- Set pressioni-livelli di allarme a display
- Ingresso sonde o galleggiante min livello
- Ingresso sensore pressione-liv. 4÷20mA
- Set pressioni-livelli avviamento/arresto

## DISPLAY VIEWS

- Voltage (V) / Frequency (Hz)
- Motor absorption (A)
- CosØ/pulse counter/running hours
- Pressure (bar)/water level (cm)
- Anomalies history

## MOTOR SETUP

- Self-learning of motor data
- Min-max current (A) and min cosØ
- Start/stop delay setting
- Max continuous operation
- Max start-ups per hours/minute
- Max klixon trips
- Alternated start-up

## ALARM MODE

- Acoustic and luminous alarm mode
- Delayable alarms via relay
- 12V alarm output

## ALARMS & PROTECTIONS

- Min-max water level
- Min-max voltage
- Phase/frequency error
- Motors min-max current/cosØ
- Max klixon trips
- Water in oil chamber
- Max start-ups per hours / per minute
- Max continuous operation

## 4 DEFAULT OPERATING MODES

### CLEAN

- Min level probe or float switch input
- Pressure sw./float sw./level probes input
- Emptying-filling mode
- Input 4÷20mA sensor if present
- Level/alarm views on display

### DARK

- Float switch inputs (normal or multi-contact types)
- Max level float switch input
- Self-holding
- Emptying/filling mode
- Input 4÷20mA sensor if present
- Pressure-level alarm setting on display

### DIGIT

- Min level probe or float switch input
- 4÷20mA pressure-level probe input
- Motor start-up/stop/alarm pressure-level setting

### MULTITANK

- Control of motors on different systems
- Setting program for each motor
- Motor 1 logic: CLEAN, DARK, DIGIT
- Motor 2 (and possible motor 3) logic: CLEAN, DARK
- Input 4÷20mA sensor if present
- Pressure-level alarm setting on display
- Min level probe or float switch input
- 4÷20mA pressure-level probe input
- Start-up/stop pressure-level setting

## AFFICHAGES

- Tension (V) / Fréquence (Hz)
- Absorption moteurs (A)
- CosØ/compteur impulsions/compt. horaire
- Pression (bars)/niveau d'eau (cm)
- Historique des anomalies

## RÉGLAGE MOTEURS

- Autoapprentissage données du moteurs
- Courant min./max. (A) et cosØ min
- Retard démarrage/arrêt
- Fonctionnement continu max
- Démarrages max heure/minutes
- Interventions klixon max
- Démarrage alterné

## MODE ALARMES

- Mode alarme sonore et lumineuse
- Alarmes du relais retardable
- Sortie alarme 12V

## ALARMES ET PROTECTIONS

- Niveau d'eau min-max
- Tension min-max
- Anomalie phases/fréquence
- Courant min-max/cosØ moteurs
- Interventions klixon max
- Eau dans la chambre de l'huile
- Démarrages heure/minutes max
- Fonctionnement continu max

## 4 PROGRAMMES DE COMMANDE

### CLEAN

- Entrée sondes ou flotteur de niveau min.
- Entrée pressostats/flotteur/sondes
- Mode vidange-remplissage
- Si présent entrée capteur 4÷20mA
- Affichage niveau/alarme sur l'écran

### DARK

- Entrée flotteurs de commande (normaux ou multicontacts)
- Entrée flotteur de niveau max.
- Automaintien
- Mode vidange/remplissage
- Si présent entrée capteur 4÷20mA
- Réglage press.-niveaux alarme sur l'écran

### DIGIT

- Entrée sondes ou flotteur de niveau min.
- Entrée capteur pression-niveau 4÷20mA
- Réglage pressions-niveaux démarrage/arrêt/alarme moteurs

### MULTITANK

- Commande moteurs installations différent.
- Param. programme pour chaque moteur
- Moteur 1 logiques: CLEAN, DARK, DIGIT
- Moteur 2 (et éventuellement moteur 3) logiques: CLEAN, DARK
- Si présent entrée capteur 4÷20mA
- Affichage niveau-pression sur l'écran
- Entrée sondes ou flotteur de niveau min
- Entrée capteur pression-niveau 4÷20mA
- Réglage pressions-niveaux démarrage/arrêt

# FULLAPP

Quadro elettronico multifunzione per avviamento diretto di motori monofase o trifase gestibile da APP

Multifunction electronic panel for direct start-up of single or three phase motors manageable with APP

Coffret électronique multifonction pour le démarrage direct de moteurs monophasée ou triphasée contrôlable par APP

0,37 → 15 kW



## SERIE FULLAPP

- **Comando remoto con APP (GSM opzionale)**
- Sezionatore generale con bloccaporta
- Fusibili di protezione
- Pulsanti AUTO-0-MAN
- Spie LED rete, auto, marcia
- 4 ingressi multifunzione configurabili: galleggiante/pressostato(N.A.)/sonde unipolari
- Uscita motore: Relè(monofase)/Contattore(trifase)
- Selettore funzionamento riempimento/svuotam.
- Regolatore sensibilità sonda
- Protezione motore da sovraccarico regolabile
- Ritardo intervento protezioni programmabile
- Uscita allarme programmabile (NC-C-NA)
- Ingresso klixon motore con spia di intervento
- Predisposizione per condensatore di marcia
- Ingresso per sensore 4÷20mA
- Display multilingua con tasti di comandi
- Visualizzazione tensione/corrente/cosØ/allarmi
- **Protezione da marcia a secco da minima corrente o cosØ**
- Ripristino automatico protezione marcia a secco
- **Auto-apprendimento dati motori**
- Protezione max interventi klixon e avviamenti/h
- Possibilità autotest periodico dei motori
- Uscita allarme ottico/acustico 12V 100mA
- Possibilità esclusione motori in avaria

### FULLAPP 2/FULLAPP 3

- Alternanza motori escludibile
- FULLAPP2: 2 Relè/Contattori - 5 ingressi multifunz.
- FULLAPP3: 3 Relè/Contattori - 6 ingressi multifunz.

## FULLAPP SERIES

- **Remote control whit APP (GSM optional)**
- Main switch with door interlock
- Protection fuses
- AUTO-0-MAN buttons
- LED power on, auto operation, motor operating
- 4 configurable multi-function inputs: multi-contact float/pressure switch (NO)/single-pole level probes
- Output: Relay(single ph.)/Contactor(three ph.)
- Selector for filling/emptying operation
- Internal regulator for probes sensitivity
- Adjustable motor overload protection
- Programmable protection activation delay
- Programmable alarm output (NO-COM-NC)
- Klixon input whit indicator light
- Provision for start-up capacitors
- Input of sensor 4÷20mA
- Multilanguage display whit command keys
- Visualization: voltage/motor current/cosØ/alerts
- **Dry running protection from minimum current or cosØ**
- Automatic restoration from dry running
- **Self-learning of motor data**
- Max klixon trips and start-ups/h protection
- Possibility of periodic self-test of motors
- Optical/acoustic alarm output 12V 100mA
- Possibility to exclude a damaged motor

### FULLAPP 2/FULLAPP 3

- Alternated start-up excludable
- FULLAPP2: 2 Relay/Contactors - 5 inputs multifunct.
- FULLAPP3: 3 Relay/Contactors - 6 inputs multifunct.

## SÉRIE FULLAPP

- **Commande à distance avec APP (GSM option)**
- Sectionneur général avec verrouillage de porte
- Fusibles de protection
- Boutons-poussoirs AUTO-0-MAN
- LED présence réseau, auto, moteur en fonction
- 4 entrées multifonct. configurables: multi-contact float/pressure switch/sondes de niveau unipolaire
- Sorties moteur: Relais(monoph.)/Contacteur(triph.)
- Sélecteur pour fonction. en remplissage/vidage
- Sélecteur intérieur pour sensibilité des sondes
- Protection électronique surcharge moteurs réglable
- Retard intervention des protections programmable
- Programmable sortie alarme (NO-COM-NC)
- Entrée Klixon avec voyant lumineux
- Prédispositions condensateur de démarrage
- Entrée capteur 4÷20mA
- Écran multilangue avec boutons de commande
- Visualisation: tension/courant moteur/cosØ/alertes
- **Protection marche à sec réglable courant min. ou cosØ**
- Rétablissement autom. protection marche à sec
- **Autoapprentissage des données des moteurs**
- Protection max interventions klixon et démarrages/h
- Possibilité diagnostic périodique moteurs
- Sortie alarme sonore/lumineuse 12V 100mA
- Possibilité exclusion moteur en avarie

### FULLAPP 2/FULLAPP 3

- Possibilité d'exclusion échange moteurs
- FULLAPP2: 2 Relais/Contacteur - 5 entrées multifoun.
- FULLAPP3: 2 Relais/Contacteur - 6 entrées multifoun.

# FULLAPP 1



## APPLICAZIONI TIPICHE / STANDARD APPLICATIONS / APPLICATIONS TYPIQUES

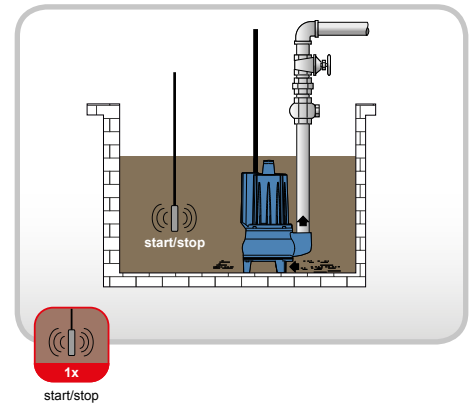
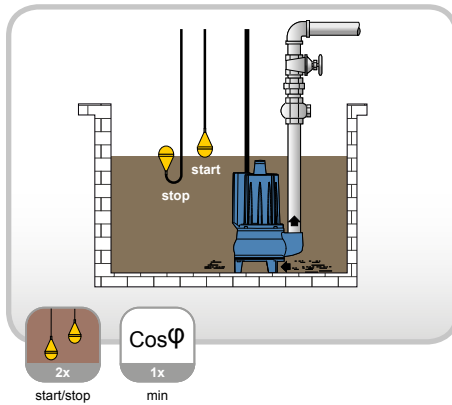
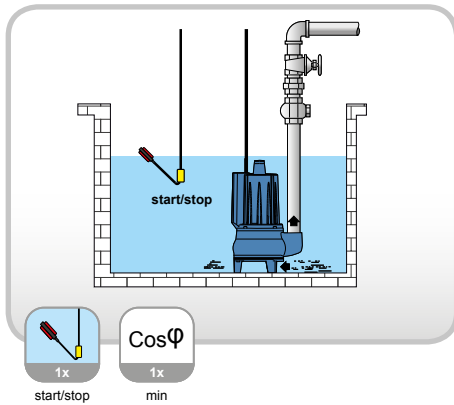
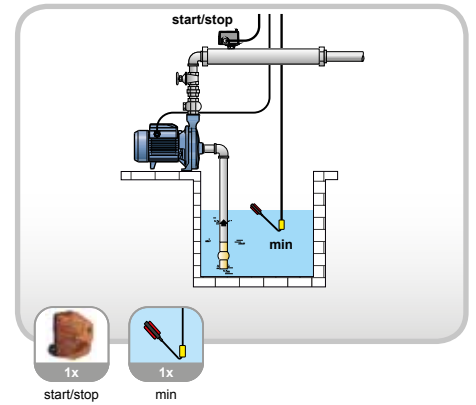
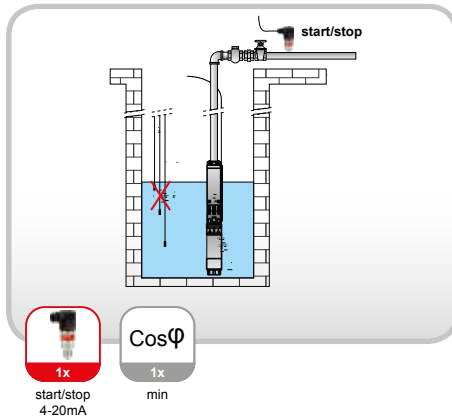
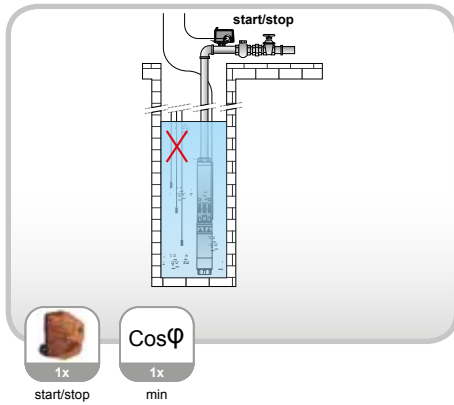

**1** **Quadro elettrico per n.1 motore**  
Control panel for n.1 motor  
Coffret électronique pour n.1 moteur



V	COD.	MODELLO / MODEL	POTENZA / POWER		CORRENTE / CURRENT	L x W x H			kg	box	
			kW	Hp		H mm	L mm	W mm			
50/60 Hz					Nx [range] A						
1~230V	020.09	FULLAPP1-M/3	0,37÷2,2	0,5÷3	1x [2÷16]	340	240	170	2,8	ABS	
	3~400V	020.10	FULLAPP1-T/10	0,55÷7,5	0,75÷10	1x [2÷15]	340	240	170	5,5	ABS
		020.11	FULLAPP1-T/15	7,5÷11	10÷15	1x [16÷24]	340	240	170	5,5	ABS
	020.12	FULLAPP1-T/20	7,5÷15	10÷20	1x [16÷30]	340	240	170	5,5	ABS	
OPTIONAL	108.80	KIT GSM	Programmazione e gestione impianti da remoto con batteria tampone		Remote programming and management of systems, with back-up battery	Programmation et la gestion des installations à distance avec batterie tampon					

# FULLAPP 2



## APPLICAZIONI TIPICHE / STANDARD APPLICATIONS / APPLICATIONS TYPIQUES

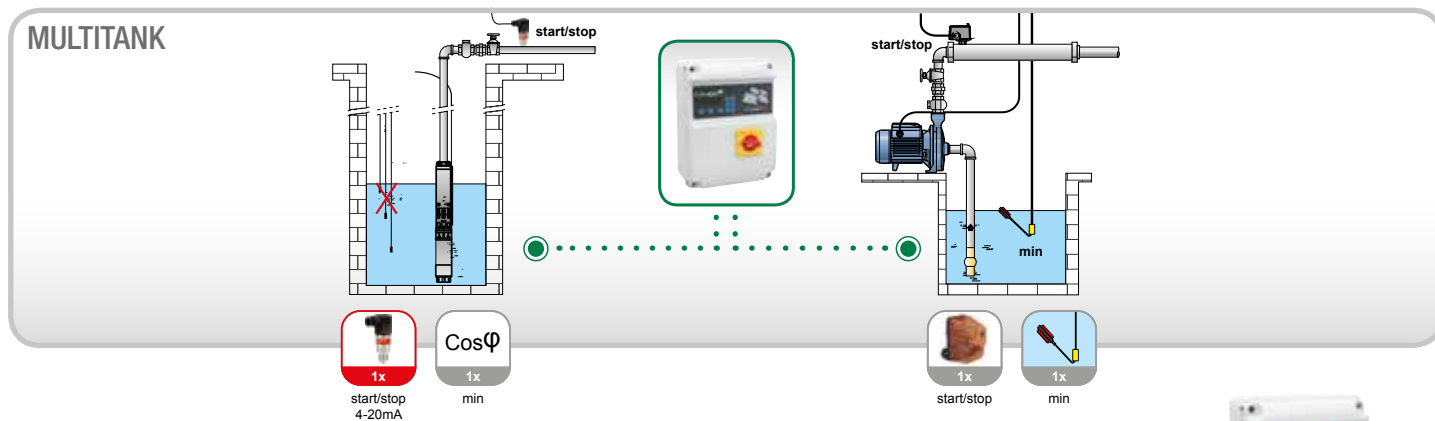
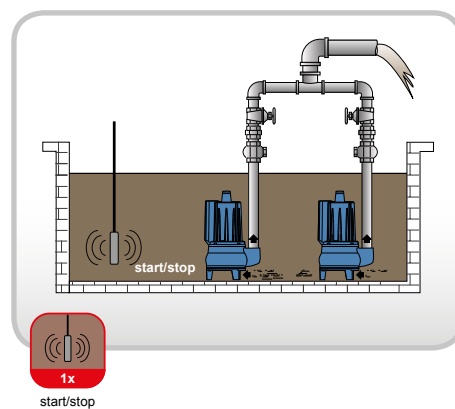
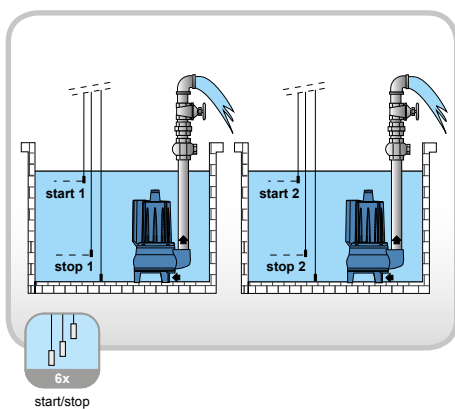
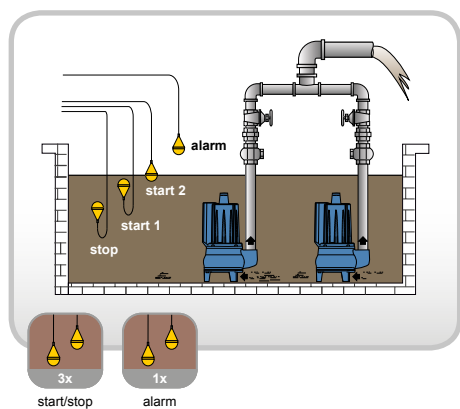
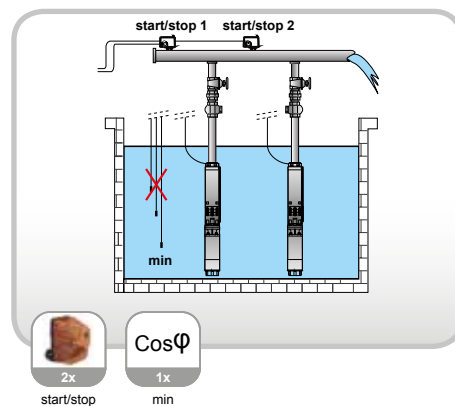
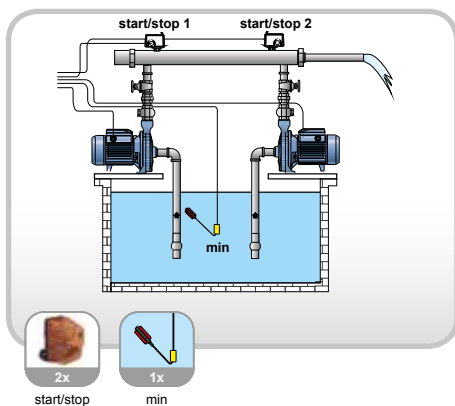
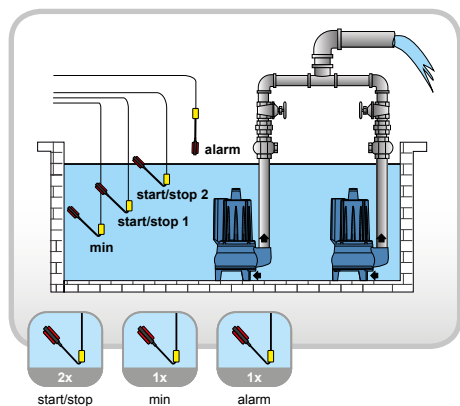

**Quadro elettrico per n.2 motori**  
Control panel for n.2 motors  
Coffret électronique pour n.2 moteurs



V	COD.	MODELLO / MODEL	POTENZA / POWER		CORRENTE / CURRENT	L-W			kg	box	
			kW	Hp		H mm	L mm	W mm			
50/60 Hz					Nx [range] A						
1-230V	020.01	FULLAPP2-M/3	0,37÷2,2	0,5÷3	2x [2÷16]	340	240	170	3	ABS	
	3~400V	020.02	FULLAPP2-T/10	0,55÷7,5	0,75÷10	2x [2÷15]	340	240	170	6	ABS
		020.03	FULLAPP2-T/15	7,5÷11	10÷15	2x [16÷24]	380	300	250	6	ABS
		020.04	FULLAPP2-T/20	7,5÷15	10÷20	2x [16÷30]	380	300	250	6	ABS
OPTIONAL	108.80	KIT GSM	Programmazione e gestione impianti da remoto con batteria tampone		Remote programming and management of systems, with back-up battery	Programmation et la gestion des installations à distance avec batterie tampon					

# FULLAPP 3



## APPLICAZIONI TIPICHE / STANDARD APPLICATIONS / APPLICATIONS TYPIQUES

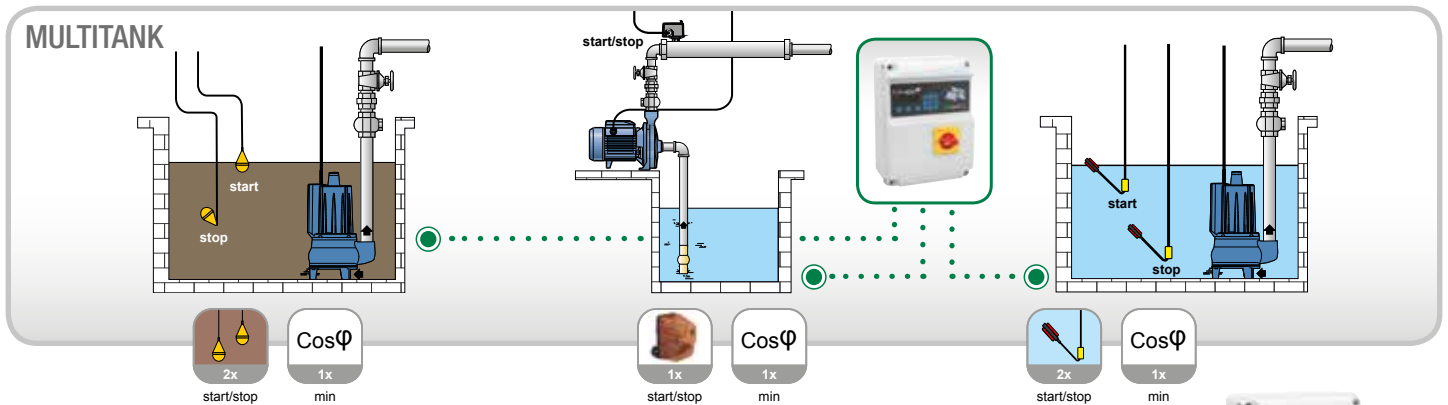
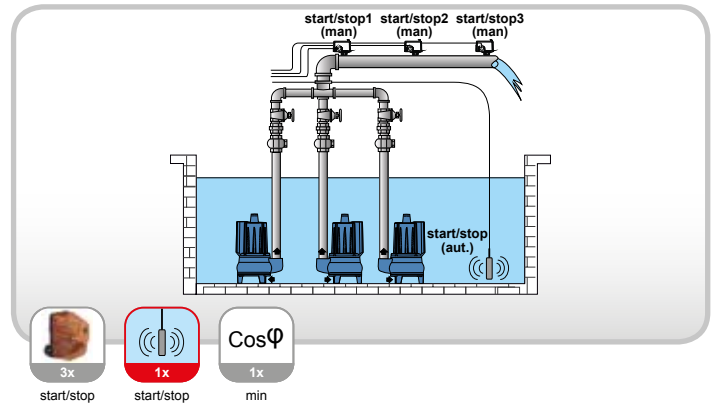
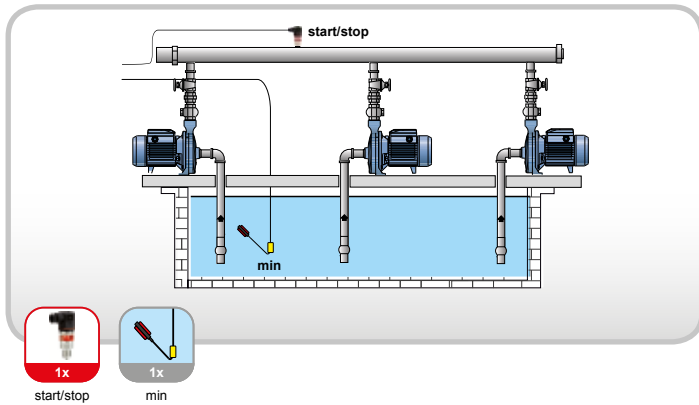
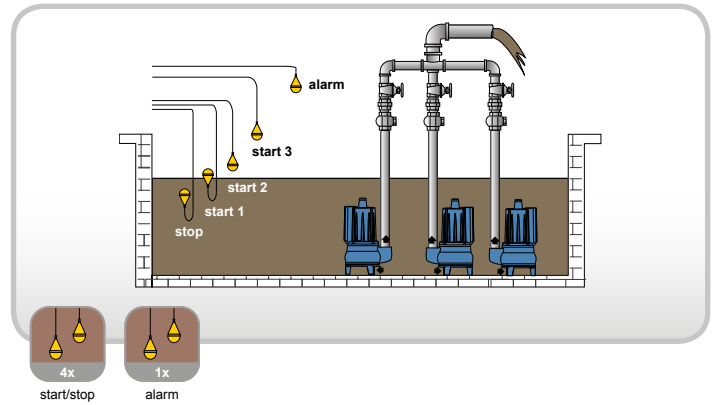
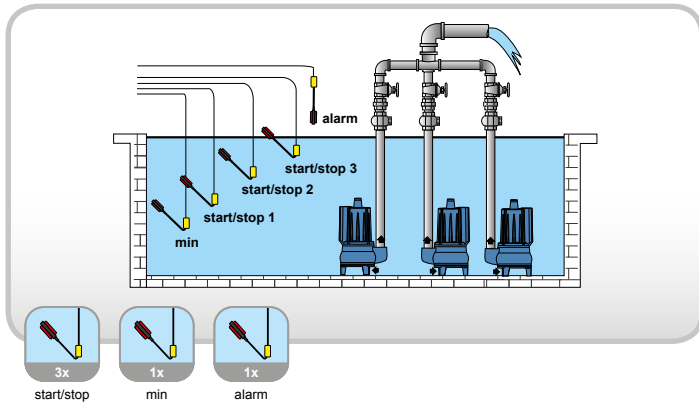

**Quadro elettrico per n.3 motori**  
Control panel for n.3 motors  
Coffret électronique pour n.3 moteurs



V	COD.	MODELLO / MODEL	POTENZA / POWER		CORRENTE / CURRENT	L-W			kg	box
			kW	Hp		H mm	L mm	W mm		
50/60 Hz					Nx [range] A					
1~230V	020.05	FULLAPP3-M/3	0,37÷2,2	0,5÷3	3x [2÷16]	420	300	150	3	ABS
3~400V	020.06	FULLAPP3-T/10	0,55÷7,5	0,75÷10	3x [2÷15]	500	400	230	10	METAL
	020.07	FULLAPP3-T/15	7,5÷11	10÷15	3x [16÷24]	500	400	230	15	METAL
	020.08	FULLAPP3-T/20	7,5÷15	10÷20	3x [16÷30]	500	400	230	15	METAL
OPTIONAL	108.80	<b>KIT GSM</b>	Programmazione e gestione impianti da remoto con batteria tampone		Remote programming and management of systems, with back-up battery	Programmation et la gestion des installations à distance avec batterie tampon				

# SIMPLEX-UP

Quadro elettronico per avviamento diretto di 1 motore monofase o trifase

Electronic panel for direct start-up of 1 single or three phase motor

Coffret électronique pour démarrage direct de 1 moteur monophasée ou triphasée

0,37 → 15 kW



## SERIE SIMPLEX-UP

- Sezionatore generale con bloccaporta
- Fusibili di protezione
- Pulsanti AUTO-0-MAN (momentaneo)
- Spie LED rete, auto, marcia
- Spie LED allarme livello, sovraccarico motore
- Ingresso galleggiante/pressostato com. motore
- Ingresso galleggiante/pressostato Allarme
- Uscita motore: Relè(monofase)/Contattore(trifase)
- Protezione motore da sovraccarico regolabile
- Tempo di intervento protezione 5"
- Uscita allarme ottico/acustico 12V 100mA
- Uscita allarme (contatti puliti NC-C-NA)
- Ingresso klixon motore con spia di intervento
- Predisposizione per condensatore di marcia
- Ingresso per 3 sonde unipolari
- Selettore riempimento/svuotamento
- Regolatore sensibilità sonda

## SIMPLEX-UP SERIES

- Main switch with door interlock
- Protection fuses
- AUTO-0-MAN buttons (manual temporary)
- LED power on, auto operation, motor operating
- LED level alarm, motor overload
- Operating input multi-contact float/pressure switch
- Alarm input multi-contact float/pressure switch
- Output: Relay(single ph.)/Contactor(three ph.)
- Adjustable motor overload protection
- Time for activation of protection 5"
- Optical/acoustic alarm output
- Alarm output (volt free contact NO-COM-NC)
- Klixon input with indicator light
- Provision for start-up capacitors
- Input for 3 single-pole level probes
- Selector for filling/emptying probes
- Internal regulator for probes sensitivity

## SÉRIE SIMPLEX-UP

- Sectionneur général avec verrouillage de porte
- Fusibles de protection
- Boutons-poussoirs AUTO-0-MAN (momentané)
- LED présence réseau, auto, moteur en fonction
- LED alarme niveau, surcharges moteur
- Entrée comande interrupteur à flotteur/pressostat
- Entrée alarme interrupteur à flotteur/pressostat
- Sortie moteur: Relais(monoph.)/Contacteur(triph.)
- Protection électronique surcharge moteurs réglable
- Temps d'intervention protection 5"
- Sortie alarme sonore/lumineuse
- Sortie alarme (NO-COM-NC volts sans contact)
- Entrée klixon avec voyant lumineux
- Prédispositions pour condensateur de démarrage
- Entrée pour sondes de niveau unipolaire
- Sélecteur fonction. en remplissage/vidage
- Sélecteur intérieur pour sensibilité des sondes



# SIMPLEX-UP



## APPLICAZIONI TIPICHE / STANDARD APPLICATIONS / APPLICATIONS TYPIQUES

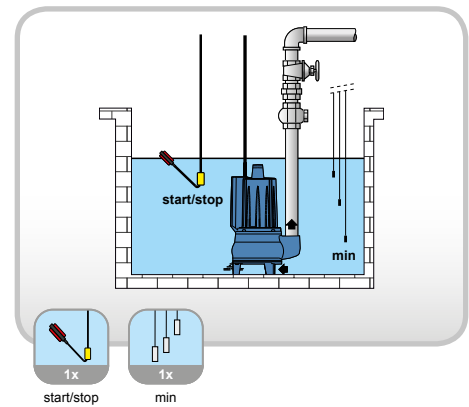
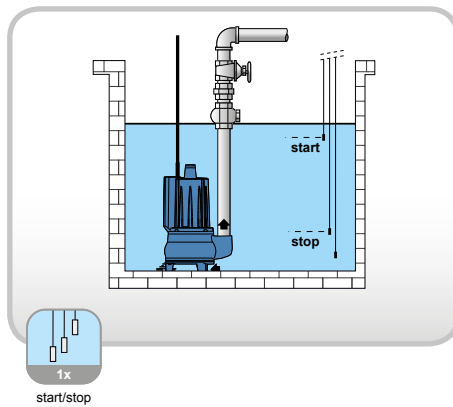
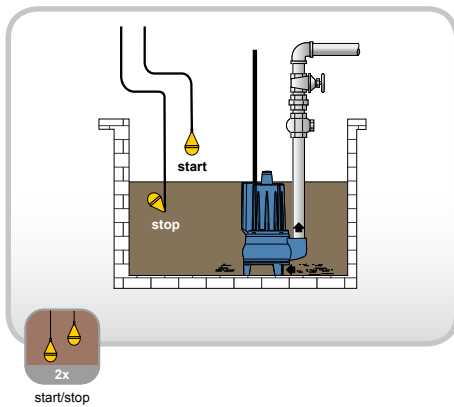
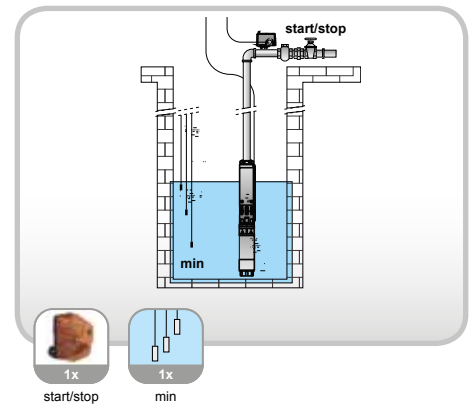
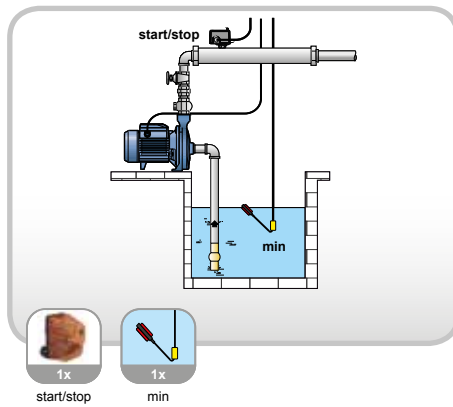
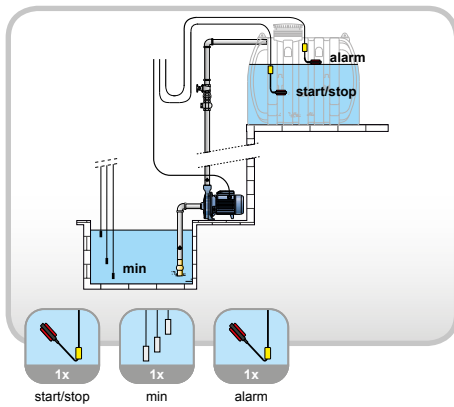

**1** Quadro elettrico per n.1 motore  
Control panel for n.1 motor  
Coffret électronique pour n.1 moteur



V	COD.	MODELLO / MODEL	POTENZA / POWER		CORRENTE / CURRENT	L x W x H			kg	box
			kW	Hp		H mm	L mm	W mm		
50/60 Hz					Nx [range] A					
1~230V	013.00	SIMPLEX-UP-M/3	0,37÷2,2	0,5÷3	1x [2÷16]	340	240	170	1,9	ABS
3~400V	013.03	SIMPLEX-UP-T/10	0,55÷7,5	0,75÷10	1x [2÷15]	340	240	170	2,4	ABS
	013.04	SIMPLEX-UP-T/15	7,5÷11	10÷15	1x [16÷24]	340	240	170	2,6	ABS
	013.10	SIMPLEX-UP-T/20	7,5÷15	10÷20	1x [16÷32]	340	240	170	2,7	ABS

# DUPLEX-UP

Quadro elettronico per avviamento diretto di 2 motori monofase o trifase

Electronic panel for direct start-up of 2 single or three phase motors

Coffret électronique pour démarrage direct de 2 moteurs monophasée ou triphasée

0,37 → 15 kW



## SERIE DUPLEX-UP

- Sezionatore generale con bloccaporta
- Fusibili di protezione
- Pulsanti AUTO-0-MAN (momentaneo)
- Spie LED rete, auto, marcia
- Spie LED allarme livello, sovraccarico motore
- Ingresso galleggiante/pressostato com. motore
- Ingresso galleggiante/pressostato Allarme
- Uscita motore: Relè(monofase)/Contattore(trifase)
- Protezione motore da sovraccarico regolabile
- Tempo di intervento protezione 5"
- Uscita allarme ottico/acustico 12V 100mA
- Uscita allarme (contatti puliti NC-C-NA)
- Ingresso klixon motore con spia di intervento
- Predisposizione per condensatore di marcia
- Alternanza motori escludibile
- 1 ingresso per comando di arresto minimo livello
- 2 Relè/Contattori - 2 ingressi galleggianti

## DUPLEX-UP SERIES

- Main switch with door interlock
- Protection fuses
- AUTO-0-MAN buttons (manual temporary)
- LED power on, auto operation, motor operating
- LED level alarm, motor overload
- Operating input multi-contact float/pressure switch
- Alarm input multi-contact float/pressure switch
- Output: Relay(single ph.)/Contactor(three ph.)
- Adjustable motor overload protection
- Time for activation of protection 5"
- Optical/acoustic alarm output
- Alarm output (volt free contact NO-COM-NC)
- Klixon input with indicator light
- Provision for start-up capacitors
- Alternated start-up excludable
- 1 input for stop command for minimum level
- 2 Relay/Contactors - 2 inputs for float

## SÉRIE DUPLEX-UP

- Sectionneur général avec verrouillage de porte
- Fusibles de protection
- Boutons-poussoirs AUTO-0-MAN (momentané)
- LED présence réseau, auto, moteur en fonction
- LED alarme niveau, surcharges moteur
- Entrée comande interrupteur à flotteur/pressostat
- Entrée alarme interrupteur à flotteur/pressostat
- Sortie moteur: Relais(monoph.)/Contacteur(triph.)
- Protection électronique surcharge moteurs réglable
- Temps d'intervention protection 5"
- Sortie alarme sonore/lumineuse
- Sortie alarme (NO-COM-NC volts sans contact)
- Entrée klixon avec voyant lumineux
- Prédispositions pour condensateur de démarrage
- Possibilité d'exclusion des l'échange moteurs
- 1 entrée pour la commande d'arrêt niveau min.
- 2 Relais/Contacteur - 2 entrées flotteur

# DUPLEX-UP



## APPLICAZIONI TIPICHE / STANDARD APPLICATIONS / APPLICATIONS TYPIQUES

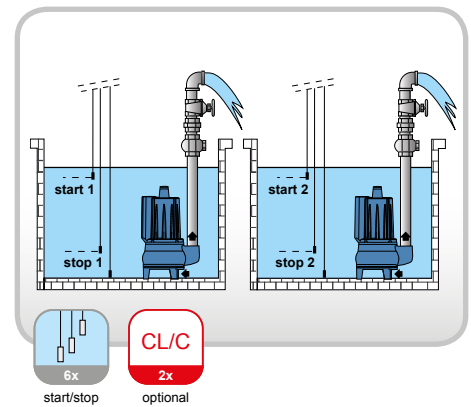
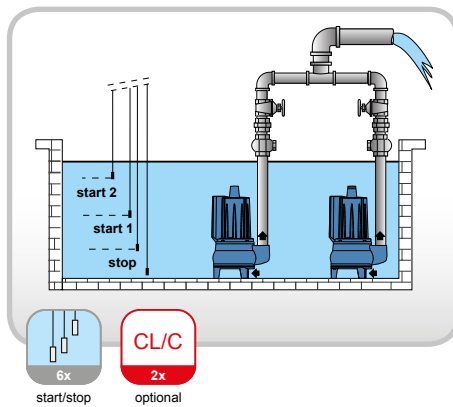
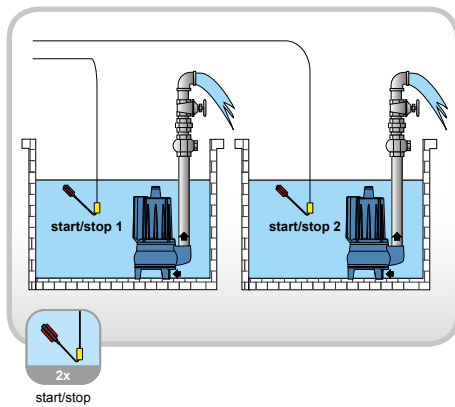
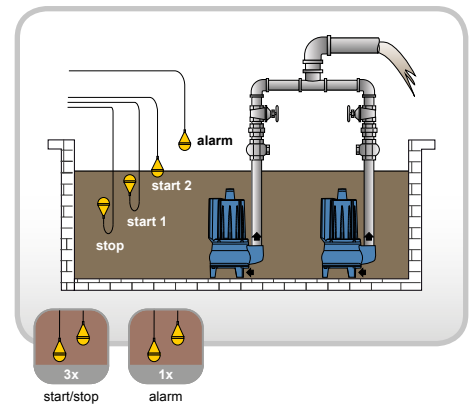
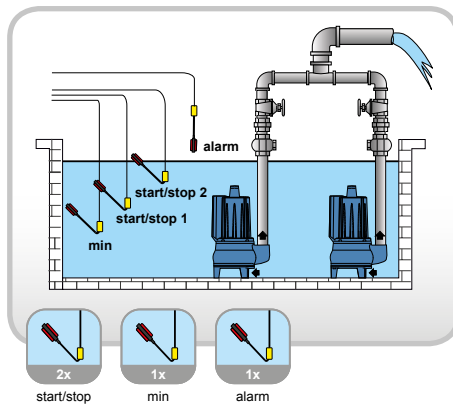
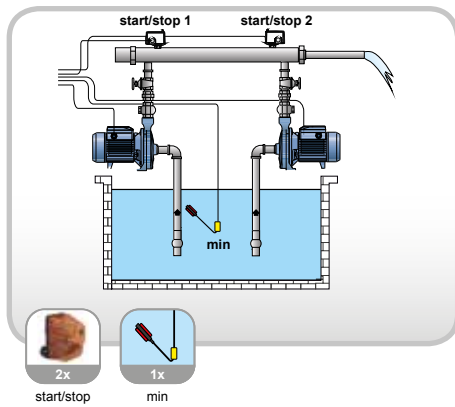

**Quadro elettrico per n.2 motori**  
Control panel for n.2 motors  
Coffret électronique pour n.2 moteurs

V	COD.	MODELLO / MODEL	POTENZA / POWER		CORRENTE / CURRENT	L x W x H			kg	box
			kW	Hp		H mm	L mm	W mm		
50/60 Hz					Nx [range] A					
1~230V	013.05	DUPLEX-UP-M/3	0,37÷2,2	0,5÷3	2x [2÷16]	340	240	170	4	ABS
3~400V	013.08	DUPLEX-UP-T/10	0,55÷7,5	0,75÷10	2x [2÷15]	340	240	170	6,5	ABS
	013.09	DUPLEX-UP-T/15	7,5÷11	10÷15	2x [16÷24]	420	300	150	6,5	ABS
	013.11	DUPLEX-UP-T/20	11÷15	15÷20	2x [16÷32]	420	300	150	6,5	ABS

# DOMINO-UP

Quadro elettronico per avviamento diretto di 1 motore monofase o trifase con controllo  $\cos\phi$  e minima corrente

Electronic panel for direct start-up of 1 single or three phase motor with  $\cos\phi$  control and minimum current

Coffret électronique pour le démarrage direct de 1 moteur monophasée ou triphasée avec contrôle  $\cos\phi$  et courant minimum

0,37 → 15 kW



## SERIE DOMINO-UP

- Sezionatore generale con bloccaporta
- Fusibili di protezione
- Pulsanti AUTO-0-MAN (momentaneo)
- Spie LED auto, marcia
- 1 ingresso per galleggiante/pressostato (N.A.)
- Uscita motore: Relè(monofase)/Contattore(trifase)
- Protezione motore da sovraccarico regolabile
- Predisposizione per condensatore di marcia
- **Protezione da marcia a secco da minima corrente o  $\cos\phi$**
- **Auto-apprendimento dati motori**
- Display con tasti di comando
- Visualizzazione tensione/corrente/ $\cos\phi$ /allarmi
- Ripristino automatico protezione marcia a secco
- Pulsante di ripristino protezioni
- Protezione per errata sequenza fasi
- Protezione min/max tensione

## DOMINO-UP SERIES

- Main switch with door interlock
- Protection fuses
- AUTO-0-MAN buttons (manual temporary)
- LED auto operation, motor operating
- 1 input multi-contact float/pressure switch (NO)
- Output: Relay(single ph.)/Contactor(three ph.)
- Adjustable motor overload protection
- Provision for start-up capacitors
- **Dry running protection from minimum current or  $\cos\phi$**
- **Self-learning of motor data**
- Multifunction display with command keys
- Visualization: voltage/motor current/ $\cos\phi$ /alarms
- Automatic restoration from dry running
- Push-buttons for protection restoration
- Motor protection for wrong phase sequence
- Min/max voltage protection

## SÉRIE DOMINO-UP

- Sectionneur général avec verrouillage de porte
- Fusibles de protection
- Boutons-poussoirs AUTO-0-MAN (momentané)
- LED auto, moteur en fonction
- 1 entrée interrupteur à flotteur/pressostat (N.A.)
- Sortie moteur: Relais(monoph.)/Contacteur(triph.)
- Protection électronique surcharge moteurs réglable
- Predispositions condensateur de démarrage
- **Protection marche à sec réglable courant min. ou  $\cos\phi$**
- **Autoapprentissage des données des moteurs**
- Écran multifonctions avec boutons de commande
- Visualisation: tension/courant moteur/ $\cos\phi$ /alarmes
- Rétablissement autom. protection marche à sec
- Boutons pour rétablissement protection
- Protection moteur erroné séquence des phases
- Protection for min/max tension

# DOMINO-UP



## APPLICAZIONI TIPICHE / STANDARD APPLICATIONS / APPLICATIONS TYPIQUES

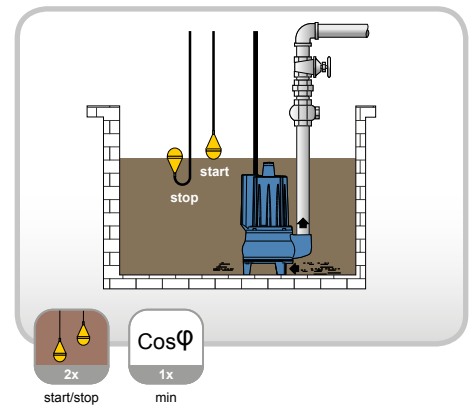
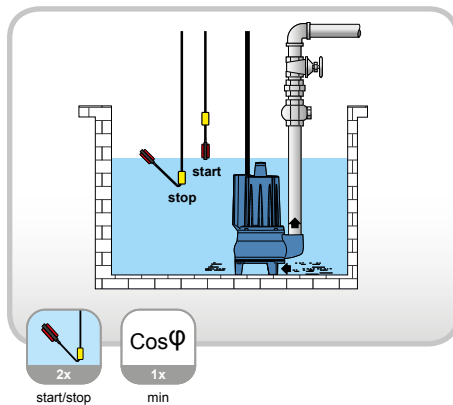
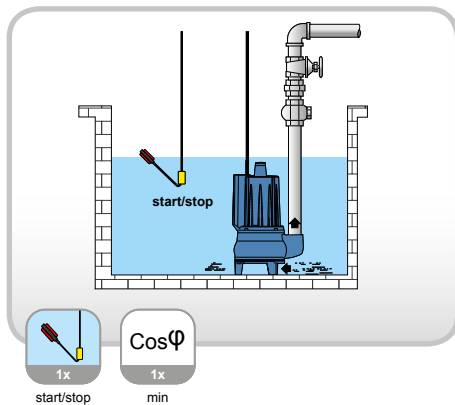
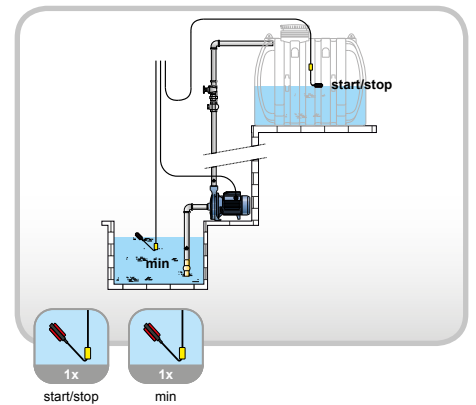
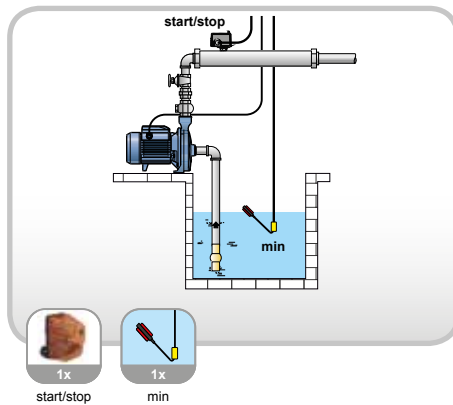
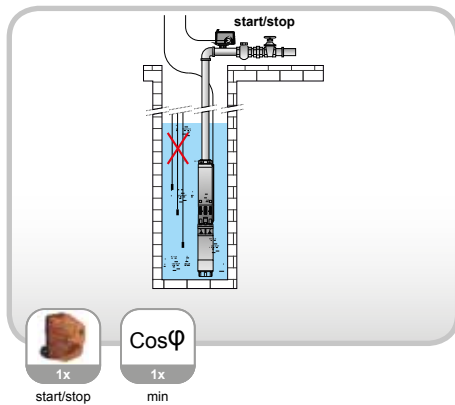

**1** **Quadro elettrico per n.1 motore**  
Control panel for n.1 motor  
Coffret électronique pour n.1 moteur



V	COD.	MODELLO / MODEL	POTENZA / POWER		CORRENTE / CURRENT	L x W x H			kg	box
			kW	Hp		H mm	L mm	W mm		
50/60 Hz					Nx [range] A					
1~230V	101.15	DOMINO-UP-M/3	0,37÷2,2	0,5÷3	1x [2÷16]	340	240	170	1,5	ABS
	101.18	DOMINO-UP-T/10	0,55÷7,5	0,75÷10	1x [2÷15]	340	240	170	2,5	ABS
	101.19	DOMINO-UP-T/15	7,5÷11	10÷15	1x [16÷24]	340	240	170	3	ABS
3~400V	101.20	DOMINO-UP-T/20	7,5÷15	10÷20	1x [16÷30]	340	240	170	3,5	ABS

# RAIN 1

Quadro elettronico per avviamento diretto di 1 motore monofase o trifase per impianti di raccolta di prima pioggia

Electronic panel for direct start-up of 1 single or three phase motor for first rainwater collection systems

Coffret électronique pour démarrage direct de 1 moteur monophasée ou triphasée pour installations de collecte des eaux de pluie

0,37 → 7,5 kW



## SERIE RAIN 1

- Sezionatore generale con bloccaporta
- Fusibili di protezione
- Pulsanti AUTO-0-MAN (momentaneo)
- Spie LED rete, auto, marcia
- Spie LED allarme livello, sovraccarico motore
- Ingresso per 3 sonde unipolari
- 1 ingresso per galleggiante/pressostato (N.A.)
- 1 uscita motore: Relè(Monofase)/Contattori(Trifase)
- Selettore funzionamento riempimento/svuotam.
- Regolatore sensibilità sonda
- Protezione motore da sovraccarico regolabile
- Uscita allarme (contatti puliti NC-C-NA)
- Predisposizione per condensatore di marcia
- Ritardo avviamento motore da 0" a 10gg
- Uscita allarme ottico/acustico 12V 100mA
- 1 ingresso per comando di arresto minimo livello
- 1 ingresso allarme
- Possibilità esclusione motori in avaria
- Pulsante di ripristino protezioni

## RAIN 1 SERIES

- Main switch with door interlock
- Protection fuses
- AUTO-0-MAN buttons (manual temporary)
- LED power on, auto operation, motor operating
- LED level alarm, motor overload
- Input for 3 single-pole level probes
- 1 input multi-contact float/pressure switch (NO)
- 1 output: Relay(single ph.)/Contactor(three ph.)
- Selector for filling/emptying operation
- Internal regulator for probes sensitivity
- Adjustable motor overload protection
- Alarm output (volt free contact NO-COM-NC)
- Provision for start-up capacitors
- Timer delay motor activation from 0" till 10 days
- Optical/acoustic alarm output
- 1 input for stop command for minimum level
- 1 alarm input
- Possibility to exclude a damaged motor
- Push-buttons for protection restoration

## SÉRIE RAIN 1

- Sectionneur général avec verrouillage de porte
- Fusibles de protection
- Boutons-poussoirs AUTO-0-MAN (momentané)
- LED présence réseau, auto, moteur en fonction
- LED alarme niveau, surcharges moteur
- Entrée sondes de niveau unipolaire
- 1 entrée interrupteur à flotteur/pressostat (N.A.)
- 1 sortie moteur: Relais(monoph.)/Contacteur(triph.)
- Sélecteur fonctionnement en remplissage/vidage
- Sélecteur intérieur sensibilité des sondes
- Protection électronique surcharge moteurs réglable
- Sortie alarme (NO-COM-NC volts sans contact)
- Predispositions condensateur de démarrage
- Temporisateur retard activation de 0" à 10 jours
- Sortie alarme sonore/lumineuse
- 1 entrée pour la commande d'arrêt niveau min.
- 1 entrée pour commande de l'alarme
- Possibilité exclusion moteur en avarie
- Boutons pour rétablissement protection

# RAIN 1



## APPLICAZIONI TIPICHE / STANDARD APPLICATIONS / APPLICATIONS TYPIQUES

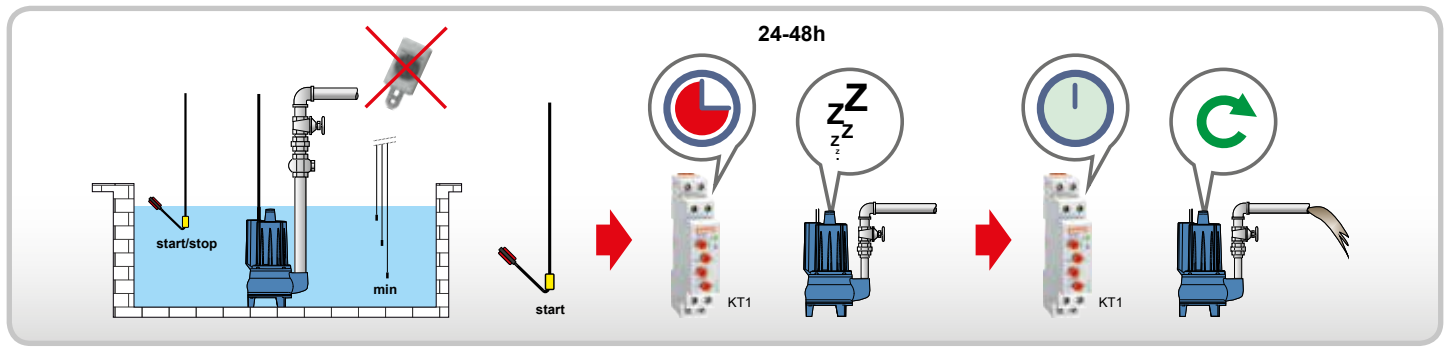

Applicazione con comando tramite galleggiante o sonde di livello senza sensore pioggia.

Application with command via float or level probe, without rain sensor.

Application avec commande par flotteur ou sondes de niveau sans capteur de pluie.

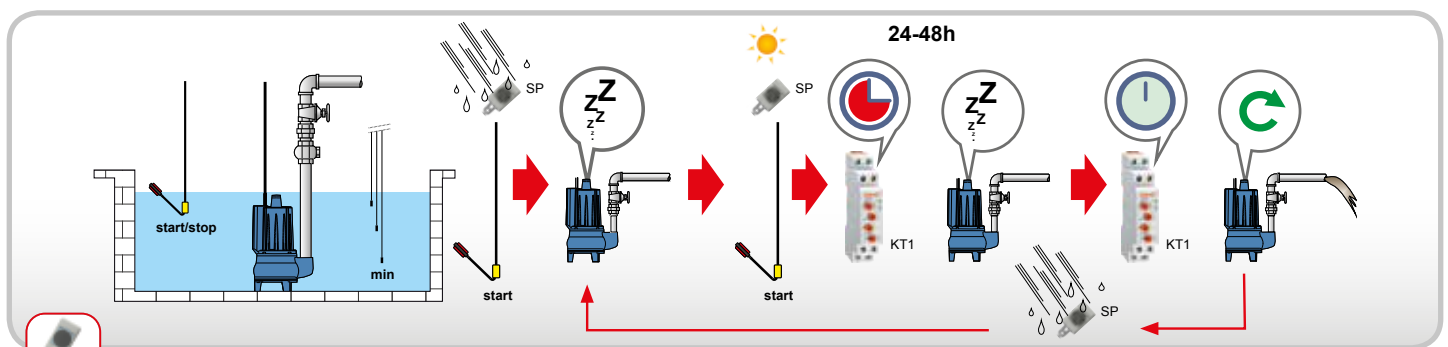

Applicazione con comando tramite galleggiante o sonde di livello con sensore pioggia.

Application with command via float or level probe, with rain sensor.

Application avec commande par flotteur ou sondes de niveau avec capteur de pluie.



**Quadro elettrico per n.1 motore**  
Control panel for n.1 motor  
Coffret électronique pour n.1 moteur



V	COD.	MODELLO / MODEL	POTENZA / POWER		CORRENTE / CURRENT	L x W x H			kg	box
			kW	Hp		H mm	L mm	W mm		
50/60 Hz					Nx [range] A					
1~230V	001.12	RAIN 1-M/3	0,37÷2,2	0,5÷3	1x [2÷16]	340	240	170	2,5	ABS
3~400V	001.15	RAIN 1-T/10	0,55÷7,5	0,75÷10	1x [2÷15]	340	240	170	3	ABS
OPTIONAL	100.50	SP/1	Sensore di pioggia		Rain sensor	Capteur de pluie				

# RAIN 2

Quadro elettronico per avviamento diretto di 2 motori monofase o trifase per impianti di raccolta di prima pioggia

Electronic panel for direct start-up of 2 single or three phase motors for first rainwater collection systems

Coffret électronique pour démarrage direct de 2 moteurs monophasée ou triphasée pour installations de collecte des eaux de pluie

0,37 → 7,5 kW



## SERIE RAIN 2

- Sezionatore generale con bloccaporta
- Fusibili di protezione
- Pulsanti AUTO-0-MAN (momentaneo)
- Spie LED rete, auto, marcia
- Spie LED allarme livello, sovraccarico motore
- 2 ingressi per galleggiante/pressostato (N.A.)
- 2 uscite motori: Relè(Monofase)/Contattori(Trifase)
- Selettore funzionamento riempimento/svuotam.
- Protezione motore da sovraccarico regolabile
- Uscita allarme (contatti puliti NC-C-NA)
- Predisposizione per condensatore di marcia
- Ritardo avviamento motori da 0" a 10gg
- Uscita allarme ottico/acustico 12V 100mA
- 1 ingresso per comando di arresto minimo livello
- 1 ingresso allarme
- Possibilità esclusione motori in avaria
- Pulsante di ripristino protezioni
- Alternanza motori escludibile

## RAIN 2 SERIES

- Main switch with door interlock
- Protection fuses
- AUTO-0-MAN buttons (manual temporary)
- LED power on, auto operation, motor operating
- LED level alarm, motor overload
- 2 inputs multi-contact float/pressure switch (NO)
- 2 outputs: Relay(single ph.)/Contactor(three ph.)
- Selector for filling/emptying operation
- Adjustable motor overload protection
- Alarm output (volt free contact NO-COM-NC)
- Provision for start-up capacitors
- Timer delay motor activation from 0" till 10 days
- Optical/acoustic alarm output
- 1 input for stop command for minimum level
- 1 alarm input
- Possibility to exclude a damaged motor
- Push-buttons for protection restoration
- Alternated start-up excludable

## SÉRIE RAIN 2

- Sectionneur général avec verrouillage de porte
- Fusibles de protection
- Boutons-poussoirs AUTO-0-MAN (momentané)
- LED présence réseau, auto, moteur en fonction
- LED alarme niveau, surcharges moteur
- 2 entrées interrupteur à flotteur/pressostat (N.A.)
- 2 sorties moteur: Relais(monoph.)/Contacteur(triph.)
- Sélecteur fonctionnement en remplissage/vidage
- Protection électronique surcharge moteurs réglable
- Sortie alarme (NO-COM-NC volts sans contact)
- Predispositions condensateur de démarrage
- Temporisateur retard activation de 0" à 10 jours
- Sortie alarme sonore/lumineuse
- 1 entrée pour la commande d'arrêt niveau min.
- 1 entrée pour commande de l'alarme
- Possibilité exclusion moteur en avaria
- Boutons pour rétablissement protection
- Possibilité d'exclusion des l'échange moteurs



# RAIN 2



## APPLICAZIONI TIPICHE / STANDARD APPLICATIONS / APPLICATIONS TYPIQUES

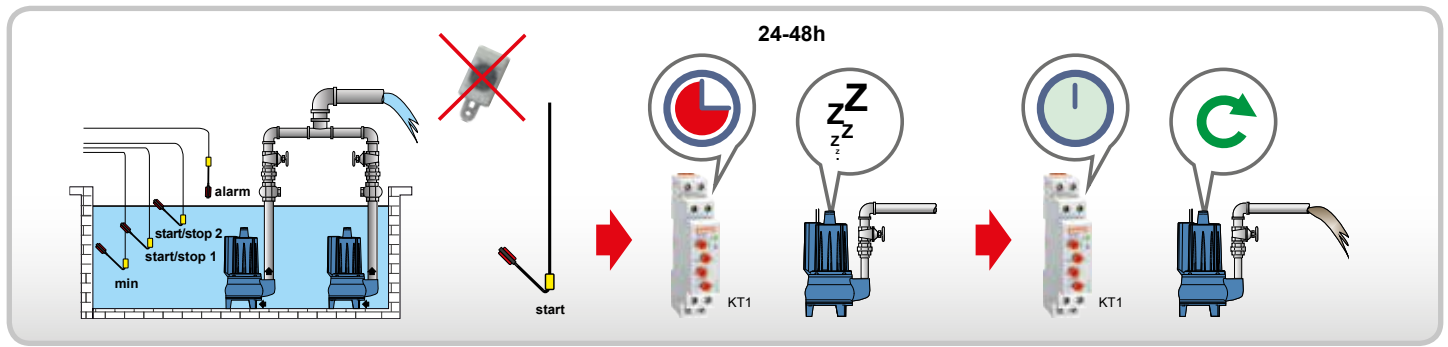

Applicazione con comando tramite galleggianti o sonde di livello senza sensore pioggia.

Application with command via float or level probe, without rain sensor.

Application avec commande par flotteur ou sondes de niveau sans capteur de pluie.

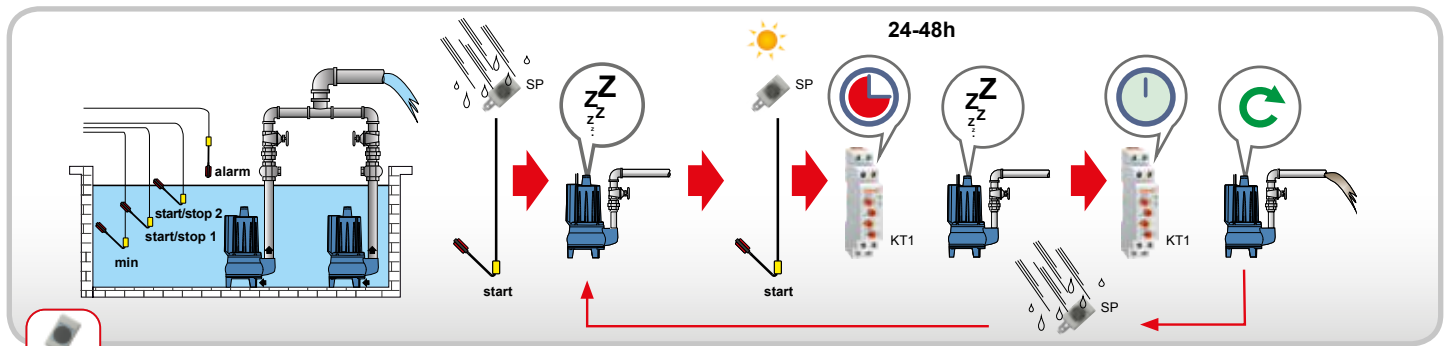

Applicazione con comando tramite galleggianti o sonde di livello con sensore pioggia.

Application with command via float or level probe, with rain sensor.

Application avec commande par flotteur ou sondes de niveau avec capteur de pluie.



**Quadro elettrico per n.2 motori**  
Control panel for n.2 motors  
Coffret électronique pour n.2 moteurs



V	COD.	MODELLO / MODEL	POTENZA / POWER		CORRENTE / CURRENT	L x W x H			kg	box
			kW	Hp		H mm	L mm	W mm		
50/60 Hz					Nx [range] A					
1~230V	001.16	RAIN 2-M/3	0,37÷2,2	0,5÷3	2x [2÷16]	340	240	170	2,5	ABS
3~400V	001.18	RAIN 2-T/10	0,55÷7,5	0,75÷10	2x [2÷15]	380	300	150	7	ABS
OPTIONAL	100.50	SP/1	Sensore di pioggia		Rain sensor	Capteur de pluie				

# DELTA APP 1

**Quadro elettromeccanico con controllo elettronico per avviamento stella-triangolo di 1 motore trifase gestibile da APP**

Electromechanical panel with electronic control for star-delta starting of 1 three phase motor manageable with APP

Coffret électromécanique avec contrôle électronique démarrage étoile-triangle de 1 moteur triphasée contrôlable par APP

2,2 → 220 kW



## SERIE DELTA APP 1

- **Comando remoto con APP (GSM opzionale)**
- Sezionatore generale con bloccaporta
- Fusibili di protezione
- Pulsanti AUTO-0-MAN (momentaneo)
- Spie LED rete, auto, marcia
- 4 ingressi multifunzione configurabili: galleggiante/pressostato(N.A.)/sonde unipolari
- Contattori di linea/stella/triangolo in AC3
- Selettore funzionamento riempimento/svuotam.
- Regolatore sensibilità sonda
- Protezione motore da sovraccarico regolabile
- Ritardo intervento protezioni programmabile
- Uscita allarme programmabile (NC-C-NA)
- Ingresso klixon motore con spia di intervento
- Ingresso per sensore 4-20mA
- Display multilingua con tasti di comandi
- Visualizzazione tensione/corrente/cos $\phi$ /allarmi
- **Protezione marcia a secco da cos $\phi$  (regolabile)**
- Ripristino automatico protezione marcia a secco
- **Auto-apprendimento dati motori**
- Protezione max interventi klixon e avviamenti/h
- Possibilità autotest periodico dei motori
- Uscita allarme ottico/acustico 12V 100mA
- Temporizzatore scambio stella-triangolo 0÷30sec.

## DELTA APP 1 SERIES

- **Remote control whit APP (GSM optional)**
- Main switch with door interlock
- Protection fuses
- AUTO-0-MAN buttons (manual temporary)
- LED power on, auto operation, motor operating
- 4 configurable multi-function inputs: multi-contact float/pressure switch (NO)/single-pole level probes
- Line/star/delta contactors AC3
- Selector for filling/emptying operation
- Internal regulator for probes sensitivity
- Adjustable motor overload protection
- Programmable protection activation delay
- Programmable alarm output (NO-COM-NC)
- Klixon input whit indicator light
- Input of sensor 4÷20mA
- Multilanguage display whit command keys
- Visualization: voltage/motor current/cos $\phi$ /alarms
- **Dry running protection adjustable from cos $\phi$**
- Automatic restoration from dry running
- **Self-learning of motor data**
- Max klixon trips and start-ups/hour protection
- Possibility of periodic self-test of motors
- Optical/acoustic alarm output
- Timer for star/delta exchange 0÷30sec.

## SÉRIE DELTA APP 1

- **Commande à distance avec APP (GSM option)**
- Sectionneur général avec verrouillage de porte
- Fusibles de protection
- Boutons-poussoirs AUTO-0-MAN (momentané)
- LED présence réseau, auto, moteur en fonction
- 4 entrées multifonct. configurables: multi-contact float/pressure switch/sondes de niveau unipolaire
- Contacteurs de ligne/étoile/triangle AC3
- Sélecteur fonctionnement en remplissage/vidage
- Sélecteur intérieur pour sensibilité des sondes
- Protection électronique surcharge moteurs réglable
- Retard intervention des protections programmable
- Programmable sortie alarme (NO-COM-NC)
- Entrée Klixon avec voyant lumineux
- Entrée capteur 4÷20mA
- Écran multilingue avec boutons de commande
- Visualisation: tension/courant moteur/cos $\phi$ /alarmes
- **Protection marche à sec réglable cos $\phi$**
- Rétablissement autom. protection marche à sec
- **Autoapprentissage des données des moteurs**
- Protection max interventions Klixon et démarrages/h
- Possibilité d'activer diagnostic périodique moteurs
- Sortie alarme sonore/lumineuse
- Temporisateur pour échange étoile-triangle 0÷30sec.

# DELTA APP 1



## APPLICAZIONI TIPICHE / STANDARD APPLICATIONS / APPLICATIONS TYPIQUES

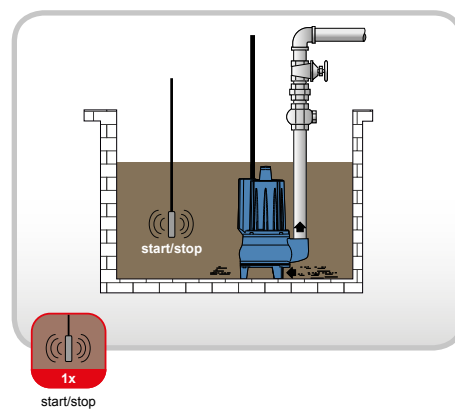
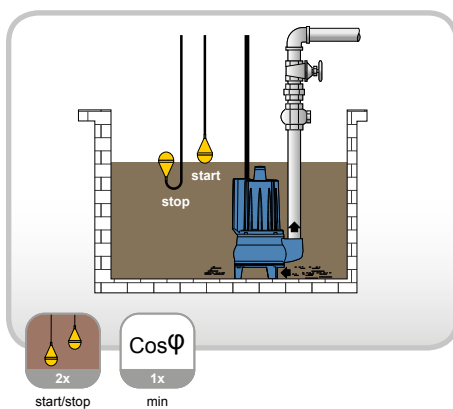
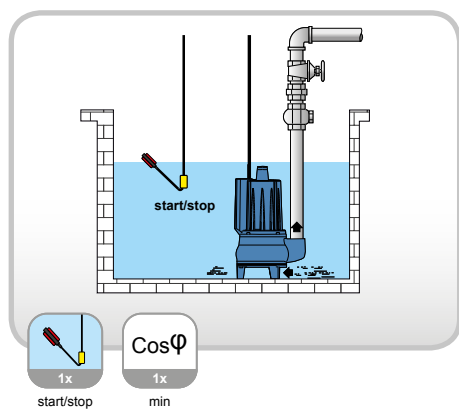
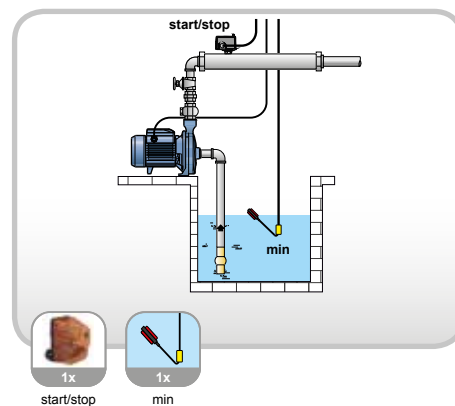
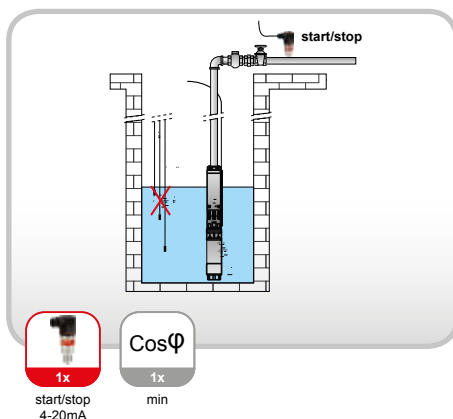
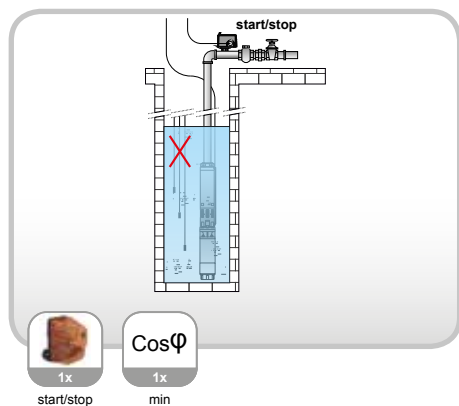

**Quadro elettrico per n.1 motore**  
Control panel for n.1 motor  
Coffret électronique pour n.1 moteur

V	COD.	MODELLO / MODEL	POTENZA / POWER		CORRENTE / CURRENT	L x W x H			kg	box
			kW	Hp		H mm	L mm	W mm		
50/60 Hz					Nx [range] A					
3~400V	006.20	DELTA APP 1/3	2,2	3	1x [5÷8]	530	400	230	16	METAL
	006.21	DELTA APP 1/5,5	4	5,5	1x [8÷11,5]	530	400	230	16	METAL
	006.22	DELTA APP 1/7,5	5,5	7,5	1x [10÷14]	530	400	230	16	METAL
	006.23	DELTA APP 1/10	7,5	10	1x [10÷16]	530	400	230	16	METAL
	006.24	DELTA APP 1/15	11	15	1x [15÷20]	530	400	230	16	METAL
	006.25	DELTA APP 1/20	15	20	1x [24÷31]	630	400	230	20	METAL
	006.26	DELTA APP 1/25	18,5	25	1x [24÷36]	630	400	230	25	METAL
	006.27	DELTA APP 1/30	22	30	1x [34÷50]	630	400	230	35	METAL
	006.28	DELTA APP 1/40	30	40	1x [48÷62]	630	400	230	30	METAL
	006.29	DELTA APP 1/50	37	50	1x [60÷77]	730	500	280	35	METAL
	006.30	DELTA APP 1/60	45	60	1x [79÷98]	840	600	330	60	METAL
	006.31	DELTA APP 1/75	55	75	1x [93÷124]	840	600	330	65	METAL
	006.32	DELTA APP 1/100	75	100	1x [125÷135]	840	600	330	70	METAL
	006.33	DELTA APP 1/125	92	125	1x [125÷155]	1240	800	330	90	METAL
	006.34	DELTA APP 1/150	110	150	1x [130÷195]	1240	800	330	95	METAL
006.35	DELTA APP 1/180	132	180	1x [155÷241]	1240	800	330	100	METAL	
006.36	DELTA APP 1/220	162	220	1x [210÷290]	1240	800	330	100	METAL	
006.37	DELTA APP 1/300	220	300	1x [260÷410]	1400	800	330	250	METAL	
OPTIONAL	108.80	KIT GSM	Programmazione e gestione impianti da remoto con batteria tampone		Remote programming and management of systems, with back-up battery	Programmation et la gestion des installations à distance avec batterie tampon				

Su richiesta è possibile realizzare il quadro per funzionamento per 2 o 3 motori. La logica di funzionamento a pag. 19

On request it is possible to realize the panel for 2 or 3 motors operation. Operating logic on pag. 19

Sur demande, il est possible de réaliser le panneau pour le fonctionnement de 2 ou 3 moteurs. Logique de fonction. page 19

Accessori a pag. 100

Accessories on pag. 100

Accessoires à la page 100

Optionals pag.107

# STATOR APP 1

Quadro elettromeccanico con controllo elettronico per avviamento di 1 motore trifase con impedenza gestibile da APP  
 Electromechanical panel with electronic control for 1 three phase motor starting with impedance manageable with APP  
 Coffret électromécanique avec contrôle électronique de 1 moteur triphasée à impédance contrôlable par APP

4 → 257 kW



## SERIE STATOR APP 1

- **Comando remoto con APP (GSM opzionale)**
- Sezionatore generale con bloccaporta
- Fusibili di protezione
- Pulsanti AUTO-0-MAN (momentaneo)
- Spie LED rete, auto, marcia
- 4 ingressi multifunzione configurabili: galleggiante/pressostato(N.A.)/sonde unipolari
- Contattori di linea/impedenza in AC3
- Impedenza di avviamento con contattore in AC3
- Selettore funzionamento riempimento/svuotam.
- Regolatore sensibilità sonda
- Protezione motore da sovraccarico regolabile
- Ritardo intervento protezioni programmabile
- Uscita allarme programmabile (NC-C-NA)
- Ingresso klixon motore con spia di intervento
- Ingresso per sensore 4-20mA
- Display multilingua con tasti di comandi
- Visualizzazione tensione/corrente/cos $\phi$ /allarmi
- **Protezione marcia a secco da cos $\phi$  (regolabile)**
- Ripristino automatico protezione marcia a secco
- **Auto-apprendimento dati motori**
- Protezione max interventi klixon e avviamenti/h
- Possibilità autotest periodico dei motori
- Uscita allarme ottico/acustico 12V 100mA
- 4 manovre/ora di cui max. 2 consecutive
- Tempo di accelerazione 15 sec. max
- Temporizzatore scambio impedenza 0÷30sec.

## STATOR APP 1 SERIES

- **Remote control whit APP (GSM optional)**
- Main switch with door interlock
- Protection fuses
- AUTO-0-MAN buttons (manual temporary)
- LED power on, auto operation, motor operating
- 4 configurable multi-function inputs: multi-contact float/pressure switch (NO)/single-pole level probes
- Line/impedance contactors AC3
- Impedance starter whit contactor in AC3
- Selector for filling/emptying operation
- Internal regulator for probes sensitivity
- Adjustable motor overload protection
- Programmable protection activation delay
- Programmable alarm output (NO-COM-NC)
- Klixon input whit indicator light
- Input of sensor 4÷20mA
- Multilanguage display whit command keys
- Visualization: voltage/motor current/cos $\phi$ /alarms
- **Dry running protection adjustable from cos $\phi$**
- Automatic restoration from dry running
- **Self-learning of motor data**
- Max klixon trips and start-ups/h protection
- Possibility of periodic self-test of motors
- Optical/acoustic alarm output
- 4 start/h of which not more than 2 consecutively
- Acceleration time max 15 sec.
- Timer for impedance exchange 0÷30sec.

## SÉRIE STATOR APP 1

- **Commande à distance avec APP (GSM option)**
- Sectionneur général avec verrouillage de porte
- Fusibles de protection
- Boutons-poussoirs AUTO-0-MAN (momentané)
- LED présence réseau, auto, moteur en fonction
- 4 entrées multifonct. configurables: multi-contact float/pressure switch/sondes de niveau unipolaire
- Contacteurs de ligne/impédance AC3
- Démarrage impédance avec contacteur en AC3
- Sélecteur fonctionnement en remplissage/vidage
- Sélecteur intérieur pour sensibilité des sondes
- Protection électronique surcharge moteurs réglable
- Retard intervention des protections programmable
- Programmable sortie alarme (NO-COM-NC)
- Entrée klixon avec voyant lumineux
- Entrée capteur 4÷20mA
- Écran multilingue avec boutons de commande
- Visualisation: tension/courant moteur/cos $\phi$ /alarmes
- **Protection marche à sec réglable cos $\phi$**
- Rétablissement autom. protection marche à sec
- **Autoapprentissage des données des moteurs**
- Protection max interventions klixon et démarrages/h
- Possibilité d'activer diagnostic périodique moteurs
- Sortie alarme sonore/lumineuse
- 4 démarrages/h, pas plus que 2 consécutives
- Temps d'accélération max 15 sec.
- Horloge pour échange d'impédance 0÷30sec.

# STATOR APP 1



## APPLICAZIONI TIPICHE / STANDARD APPLICATIONS / APPLICATIONS TYPIQUES

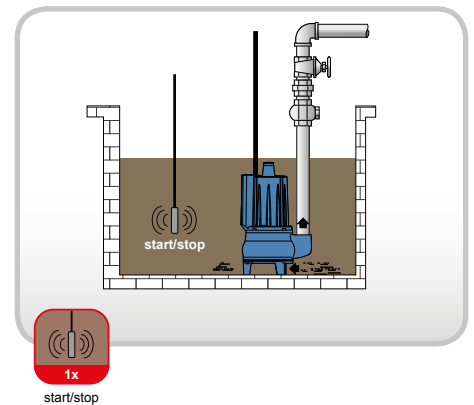
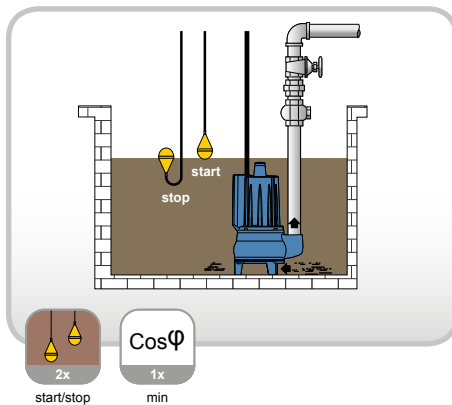
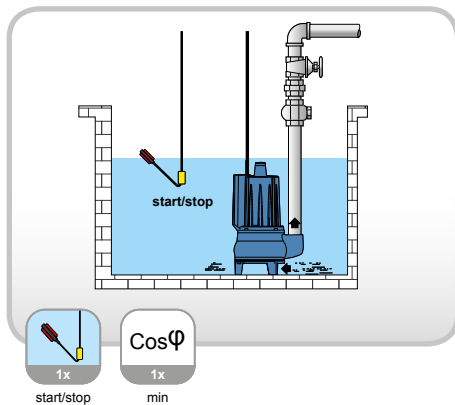
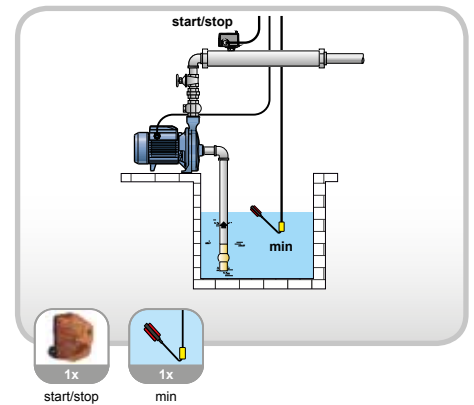
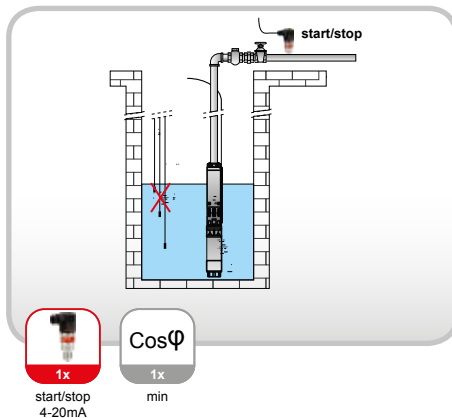
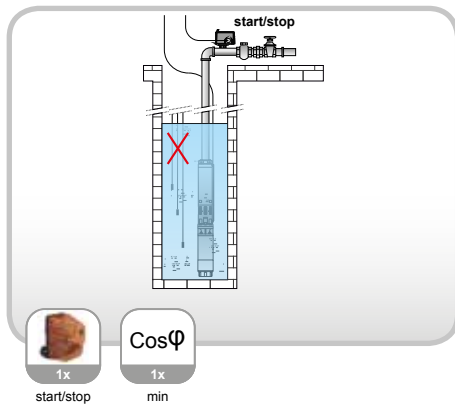

**Quadro elettrico per n.1 motore**  
Control panel for n.1 motor  
Coffret électronique pour n.1 moteur



V	COD.	MODELLO / MODEL	POTENZA / POWER		CORRENTE / CURRENT	L x W x H			kg	box
			kW	Hp		H mm	L mm	W mm		
50/60 Hz	008.20	STATOR APP 1 /5,5	4	5,5	1x [7,6÷12]	630	400	230	25	METAL
	008.21	STATOR APP 1 /7,5	5,5	7,5	1x [11÷15]	630	400	230	30	METAL
	008.22	STATOR APP 1 /10	7,5	10	1x [14÷19]	630	400	230	30	METAL
	008.23	STATOR APP 1 /12,5	9,2	12,5	1x [17÷21]	630	400	230	36	METAL
	008.24	STATOR APP 1 /15	11	15	1x [20÷27]	630	400	230	36	METAL
	008.25	STATOR APP 1 /20	15	20	1x [27÷32]	730	500	280	38	METAL
	008.26	STATOR APP 1 /25	18,5	25	1x [30÷42]	730	500	280	41	METAL
	008.27	STATOR APP 1 /35	22÷25,7	30÷35	1x [39÷55]	840	600	330	43	METAL
	008.28	STATOR APP 1 /40	30	40	1x [51÷69]	1040	800	330	105	METAL
	008.29	STATOR APP 1 /50	37	50	1x [60÷80]	1040	800	330	110	METAL
	008.30	STATOR APP 1 /60	44	60	1x [77÷93]	1040	800	330	110	METAL
	008.31	STATOR APP 1 /80	55÷59	75÷80	1x [77÷127]	1040	800	330	115	METAL
	008.32	STATOR APP 1 /90	66	90	1x [102÷155]	1400	800	430	130	METAL
	008.33	STATOR APP 1 /100	75	100	1x [102÷170]	1400	800	430	140	METAL
	008.34	STATOR APP 1 /150	110	150	1x [127÷212]	1600	1000	430	240	METAL
	008.35	STATOR APP 1 /180	132	180	1x [153÷255]	1600	1000	430	250	METAL
	008.36	STATOR APP 1 /250	184	250	1x [212÷357]	1800	1000	430	280	METAL
	008.37	STATOR APP 1 /300	220	300	1x [255÷425]	2000	1600	500	370	METAL
008.38	STATOR APP 1 /350	257	350	1x [306÷510]	2000	1600	500	380	METAL	
OPTIONAL	108.80	KIT GSM	Programmazione e gestione impianti da remoto con batteria tampone		Remote programming and management of systems, with back-up battery	Programmation et la gestion des installations à distance avec batterie tampon				

Su richiesta è possibile realizzare il quadro per funzionamento per 2 o 3 motori. La logica di funzionamento a pag. 19

On request it is possible to realize the panel for 2 or 3 motors operation. Operating logic on pag. 19

Sur demande, il est possible de réaliser le panneau pour le fonctionnement de 2 ou 3 moteurs. Logique de fonction. page 19

Accessori a pag. 100

Accessories on pag. 100

Accessoires à la page 100

Optionals pag.107

# SOFT APP 1

Quadro elettromeccanico con controllo elettronico per avviamento soft-start di 1 motore trifase gestibile da APP

Electromechanical panel with electronic control for soft start of 1 three phase motor manageable with APP

Coffret électromécanique avec contrôle électronique pour le démarrage progressif de 1 moteur triphasée contrôlable par APP

5,5 → 132 kW



## SERIE SOFT APP 1

- **Comando remoto con APP (GSM opzionale)**
- Sezionatore generale con bloccaporta
- Fusibili di protezione
- Pulsanti AUTO-0-MAN (momentaneo)
- Spie LED rete, auto, marcia
- 4 ingressi multifunzione configurabili: galleggiante/pressostato(N.A.)/sonde unipolari
- Contattore di linea in AC3
- Selettore funzionamento riempimento/svuotam.
- Regolatore sensibilità sonde
- Protezione motore da sovraccarico regolabile
- Ritardo intervento protezioni programmabile
- Uscita allarme programmabile (NC-C-NA)
- Ingresso klixon motore con spia di intervento
- Ingresso per sensore 4-20mA
- Display multilingua con tasti di comandi
- Visualizzazione tensione/corrente/cos $\phi$ /allarmi
- **Protezione marcia a secco da cos $\phi$  (regolabile)**
- Ripristino automatico protezione marcia a secco
- **Auto-apprendimento dati motori**
- Protezione max interventi klixon e avviamenti/h
- Possibilità autotest periodico dei motori
- Uscita allarme ottico/acustico 12V 100mA
- Kit ventilazione forzata
- Soft-starter interno con: display LCD multilingua, menù di programmazione (base, esteso e funzioni), orologio datario, controllo remoto a PC con RS232/RS485
- Protezioni mancanza fase, minima e massima tensione, sequenza fasi

## SOFT APP 1 SERIES

- **Remote control whit APP (GSM optional)**
- Main switch with door interlock
- Protection fuses
- AUTO-0-MAN buttons (manual temporary)
- LED power on, auto operation, motor operating
- 4 configurable multi-function inputs: multi-contact float/pressure switch (NO)/single-pole level probes
- Line contactor AC3
- Selector for filling/emptying operation
- Internal regulator for probes sensitivity
- Adjustable motor overload protection
- Programmable protection activation delay
- Programmable alarm output (NO-COM-NC)
- Klixon input whit indicator light
- Input of sensor 4÷20mA
- Multilanguage display whit command keys
- Visualization: voltage/motor current/cos $\phi$ /alarms
- **Dry running protection adjustable from cos $\phi$**
- Automatic restoration from dry running
- **Self-learning of motor data**
- Max klixon trips and start-ups/h protection
- Possibility of periodic self-test of motors
- Optical/acoustic alarm output
- Forced ventilation kit
- Internal soft starter with: LCD multilanguage, set-up menu (base, extended and functions), clock datary, remote control by pc RS232/RS485
- Lack of phases protection, min and max voltage, phase sequence

## SÉRIE SOFT APP 1

- **Commande à distance avec APP (GSM option)**
- Sectionneur général avec verrouillage de porte
- Fusibles de protection
- Boutons-poussoirs AUTO-0-MAN (momentané)
- LED présence réseau, auto, moteur en fonction
- 4 entrées multifonct. configurables: multi-contact float/pressure switch/sondes de niveau unipolaire
- Contacteur de ligne AC3
- Sélecteur fonctionnement en remplissage/vidage
- Sélecteur intérieur pour sensibilité des sondes
- Protection électronique surcharge moteurs réglable
- Retard intervention des protections programmable
- Programmable sortie alarme (NO-COM-NC)
- Entrée klixon avec voyant lumineux
- Entrée capteur 4÷20mA
- Écran multilangue avec boutons de commande
- Visualisation: tension/courant moteur/cos $\phi$ /alarmes
- **Protection marche à sec réglable cos $\phi$**
- Rétablissement autom. protection marche à sec
- **Autoapprentissage des données des moteurs**
- Protection max interventions klixon et démarrages/h
- Possibilité d'activer diagnostic périodique moteurs
- Sortie alarme sonore/lumineuse
- Kit de ventilation forcée
- Démarrage progressif avec: écran multilingue, menu de programmation (base, étendu et fonctions), horloge, calendrier, contrôle éloigné par RS232 avec ordinateur
- Protection en absence de phase, min et max tension, séquence des phases

# SOFT APP 1



## APPLICAZIONI TIPICHE / STANDARD APPLICATIONS / APPLICATIONS TYPIQUES

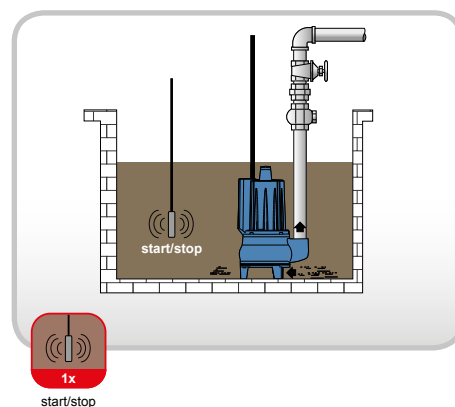
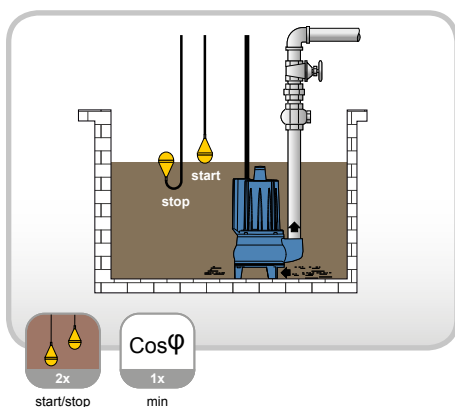
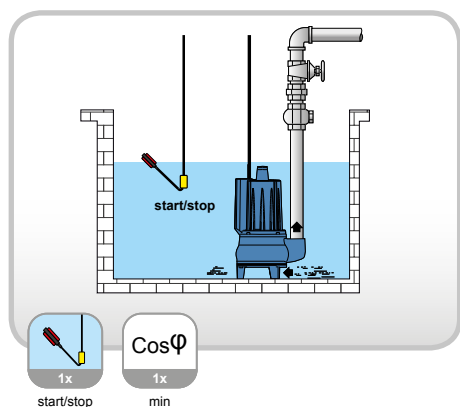
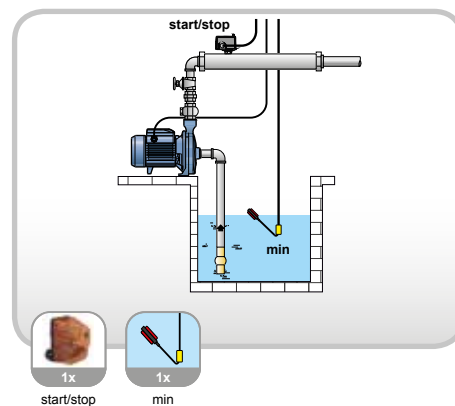
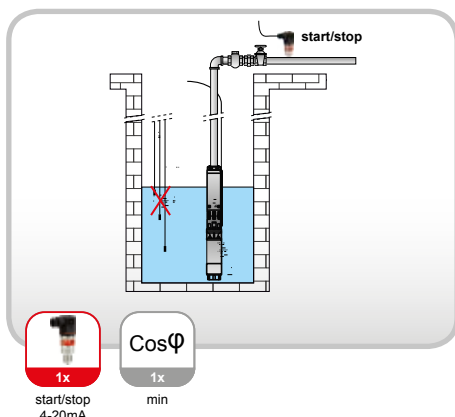
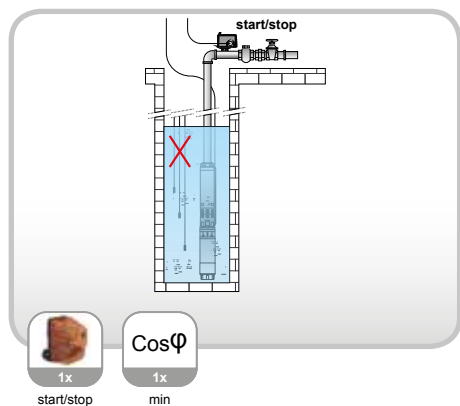

**Quadro elettrico per n.1 motore**  
Control panel for n.1 motor  
Coffret électronique pour n.1 moteur



V	COD.	MODELLO / MODEL	POTENZA / POWER		CORRENTE / CURRENT	L x W x H			kg	box
			kW	Hp		H mm	L mm	W mm		
50/60 Hz					Nx [range] A					
3~400V	009.19	SOFT APP 1 /7,5	5,5	7,5	1x [11÷15]	730	500	280	38	METAL
	009.20	SOFT APP 1 /15	11	15	1x [20÷27]	730	500	280	38	METAL
	009.21	SOFT APP 1 /25	18,5	25	1x [30÷42]	730	500	280	40	METAL
	009.22	SOFT APP 1 /30	22	30	1x [39÷55]	730	500	280	40	METAL
	009.23	SOFT APP 1 /40	30	40	1x [51÷69]	830	600	330	50	METAL
	009.24	SOFT APP 1 /50	37	50	1x [60÷80]	830	600	330	50	METAL
	009.25	SOFT APP 1 /60	44	60	1x [77÷93]	830	600	330	55	METAL
	009.26	SOFT APP 1 /80	55÷59	75÷80	1x [77÷127]	1030	800	300	70	METAL
	009.27	SOFT APP 1 /100	75	100	1x [102÷156]	1030	800	300	80	METAL
	009.28	SOFT APP 1 /125	92	125	1x [102÷182]	1400	800	430	130	METAL
	009.29	SOFT APP 1 /150	110	150	1x [127÷212]	1400	800	430	140	METAL
009.30	SOFT APP 1 /180	132	180	1x [153÷255]	1400	800	430	150	METAL	
OPTIONAL	108.80	KIT GSM	Programmazione e gestione impianti da remoto con batteria tampone		Remote programming and management of systems, with back-up battery	Programmation et la gestion des installations à distance avec batterie tampon				
	111.091	TR/ADX	Kit display esterno		External display kit	Kit écran extérieur				

Su richiesta è possibile realizzare il quadro per funzionamento per 2 o 3 motori. La logica di funzionamento a pag. 19

On request it is possible to realize the panel for 2 or 3 motors operation. Operating logic on pag. 19

Sur demande, il est possible de réaliser le panneau pour le fonctionnement de 2 ou 3 moteurs. Logique de fonction. page 19

Accessori a pag. 100

Accessories on pag. 100

Accessoires à la page 100

Optionals pag.107

# INVERTER APP 1

Quadro elettromeccanico con controllo elettronico per avviamento di 1 motore trifase con inverter di frequenza gestibile da APP  
 Electromechanical panel with electronic control for start-up with frequency inverter of 1 three phase motor manageable with APP  
 Coffret électromécanique avec contrôle électronique pour le démarrage avec convertisseur de fréq. de 1 moteur triph. contrôlable par APP

1,1 → 200 kW



## SERIE INVERTER APP 1

- **Comando remoto con APP (GSM opzionale)**
- Sezionatore generale con bloccaporta
- Fusibili di protezione
- Pulsanti AUTO-0-MAN (momentaneo)
- Spie LED rete, auto, marcia
- 4 ingressi multifunzione configurabili: galleggiante/pressostato(N.A.)/sonde unipolari
- Contattore di linea in AC3
- Selettore funzionamento riempimento/svuotam.
- Regolatore sensibilità sonda
- Protezione motore da sovraccarico regolabile
- Ritardo intervento protezioni programmabile
- Uscita allarme programmabile (NC-C-NA)
- Ingresso klixon motore con spia di intervento
- Ingresso per sensore 4-20mA
- Display multilingua con tasti di comandi
- Visualizzazione tensione/corrente/allarmi
- Ripristino automatico protezione marcia a secco
- **Auto-apprendimento dati motori**
- Protezione max interventi klixon e avviamenti/h
- Possibilità autotest periodico dei motori
- Uscita allarme ottico/acustico 12V 100mA
- Kit ventilazione forzata
- Inverter di Frequenza con: display LCD, orologio datario+eventi, controllo remoto a PC con RS232/RS485
- Protezioni mancanza fase, minima e massima tensione, sequenza fasi

## INVERTER APP 1 SERIES

- **Remote control whit APP (GSM optional)**
- Main switch with door interlock
- Protection fuses
- AUTO-0-MAN buttons (manual temporary)
- LED power on, auto operation, motor operating
- 4 configurable multi-function inputs: multi-contact float/pressure switch (NO)/single-pole level probes
- Line contactor AC3
- Selector for filling/emptying operation
- Internal regulator for probes sensitivity
- Adjustable motor overload protection
- Programmable protection activation delay
- Programmable alarm output (NO-COM-NC)
- Klixon input whit indicator light
- Input of sensor 4÷20mA
- Multilanguage display whit command keys
- Visualization: voltage/motor current/alarms
- Automatic restoration from dry running
- **Self-learning of motor data**
- Maximum klixon trips and start-ups/h protection
- Possibility of periodic self-test of motors
- Optical/acoustic alarm output
- Forced ventilation kit
- Electronic frequency inverter with: back-lighted LCD, clock datary+events, remote control by pc whit RS232/RS485
- Phase failure protection, min/max voltage protection, phase-sequence protection

## SÉRIE INVERTER APP 1

- **Commande à distance avec APP (GSM option)**
- Sectionneur général avec verrouillage de porte
- Fusibles de protection
- Boutons-poussoirs AUTO-0-MAN (momentané)
- LED présence réseau, auto, moteur en fonction
- 4 entrées multifonct. configurables: multi-contact float/pressure switch/sondes de niveau unipolaire
- Contacteur de ligne AC3
- Sélecteur fonctionnement en remplissage/vidage
- Sélecteur intérieur pour sensibilité des sondes
- Protection électronique surcharge moteurs réglable
- Retard intervention des protections programmable
- Programmable sortie alarme (NO-COM-NC)
- Entrée klixon avec voyant lumineux
- Entrée capteur 4÷20mA
- Écran multilangue avec boutons de commande
- Visualisation: tension/courant moteur/alarms
- Rétablissement autom. protection marche à sec
- **Autoapprentissage des données des moteurs**
- Protection max interventions klixon et démarrages/h
- Possibilité d'activer diagnostic périodique moteurs
- Sortie alarme sonore/lumineuse
- Kit de ventilation forcée
- Variateur de fréquence électronique avec: écran, horloge calendrier+événements, contrôle par RS232/RS485 avec ordinateur
- Protection en absence de phase, min et max tension, séquence des phases



# INVERTER APP 1



## APPLICAZIONI TIPICHE / STANDARD APPLICATIONS / APPLICATIONS TYPIQUES

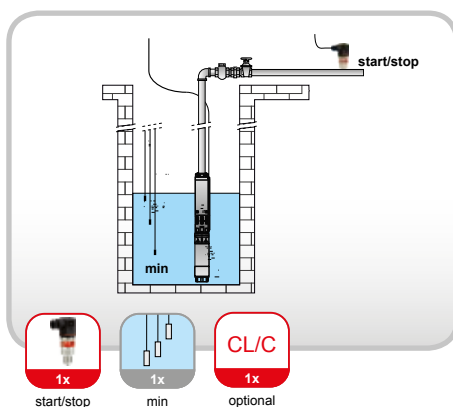
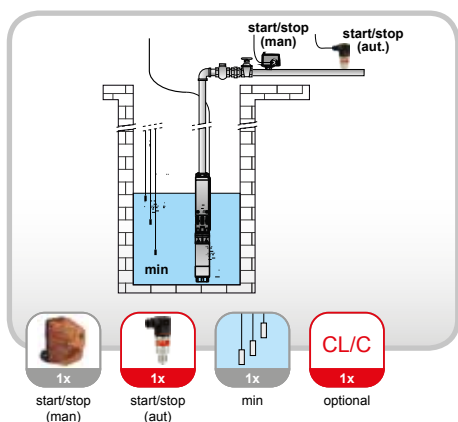
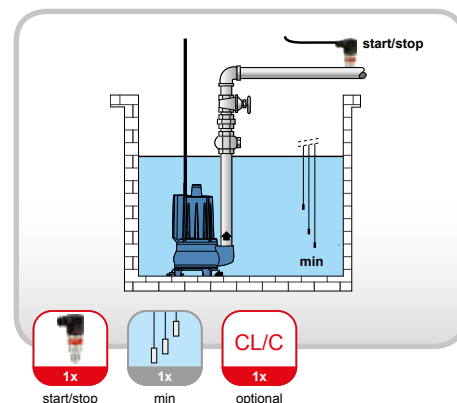
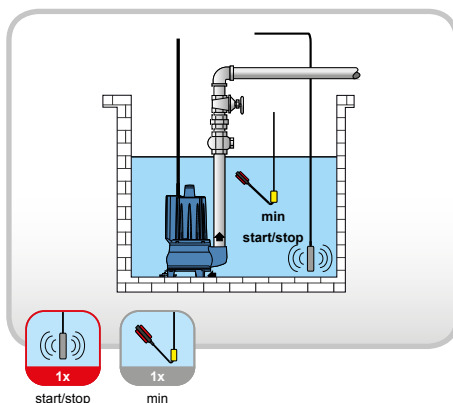
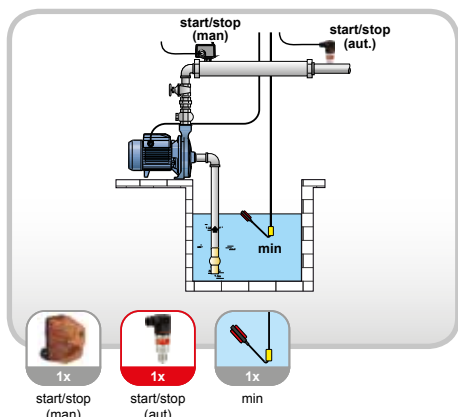

**Quadro elettrico per n.1 motore**  
Control panel for n.1 motor  
Coffret électronique pour n.1 moteur

V	COD.	MODELLO / MODEL	POTENZA / POWER		CORRENTE / CURRENT	L x W x H			kg	box
			kW	Hp		H mm	L mm	W mm		
50/60 Hz					Nx [range] A					
3~400V	016.222	INVERTER APP 1/1.5	1,1	1,5	1x [1 ÷ 3,6]	730	500	280	20	METAL
	016.223	INVERTER APP 1/2	1,5	2	1x [1,5 ÷ 4,5]	730	500	280	20	METAL
	016.224	INVERTER APP 1/3	2,2	3	1x [2 ÷ 6,2]	730	500	280	25	METAL
	016.225	INVERTER APP 1/4	3	4	1x [2,5 ÷ 8]	730	500	280	25	METAL
	016.226	INVERTER APP 1/5.5	4	5,5	1x [3 ÷ 9,7]	730	500	280	25	METAL
	016.227	INVERTER APP 1/7.5	5,5	7,5	1x [4 ÷ 13,8]	730	500	280	25	METAL
	016.228	INVERTER APP 1/10	7,5	10	1x [5 ÷ 17,2]	730	500	280	25	METAL
	016.229	INVERTER APP 1/15	11	15	1x [7,5 ÷ 25,4]	730	500	280	25	METAL
	016.230	INVERTER APP 1/20	15	20	1x [10,5 ÷ 34,1]	1030	800	330	50	METAL
	016.231	INVERTER APP 1/25	18,5	25	1x [12,5 ÷ 41,8]	1030	800	330	50	METAL
	016.232	INVERTER APP 1/30	22	30	1x [14,5 ÷ 48,4]	1030	800	330	50	METAL
	016.233	INVERTER APP 1/40	30	40	1x [11 ÷ 62]	1500	800	530	55	METAL
	016.234	INVERTER APP 1/50	37	50	1x [13 ÷ 73]	1500	800	530	55	METAL
	016.235	INVERTER APP 1/60	45	60	1x [15 ÷ 88]	1700	1000	540	55	METAL
	016.236	INVERTER APP 1/75	55	75	1x [18 ÷ 106]	1700	1000	540	80	METAL
	016.237	INVERTER APP 1/100	75	100	1x [25 ÷ 145]	1700	1000	540	85	METAL
	016.238	INVERTER APP 1/125	90	125	1x [29 ÷ 169]	1700	1000	540	90	METAL
016.239	INVERTER APP 1/150	110	150	1x [35 ÷ 206]	1700	1000	540	100	METAL	
016.240	INVERTER APP 1/180	132	180	1x [41 ÷ 246]	2300	1200	630	180	METAL	
016.241	INVERTER APP 1/220	160	220	1x [49 ÷ 293]	2300	1200	630	190	METAL	
016.242	INVERTER APP 1/270	200	270	1x [61 ÷ 363]	2300	1200	630	200	METAL	
OPTIONAL	108.80	KIT GSM	Programmazione e gestione impianti da remoto con batteria tampone		Remote programming and management of systems, with back-up battery	Programmation et la gestion des installations à distance avec batterie tampon				

Su richiesta è possibile realizzare il quadro per funzionamento per 2 o 3 motori. La logica di funzionamento a pag. 19

On request it is possible to realize the panel for 2 or 3 motors operation. Operating logic on pag. 19

Sur demande, il est possible de réaliser le panneau pour le fonctionnement de 2 ou 3 moteurs. Logique de fonction. page 19

Accessori a pag. 100

Accessories on pag. 100

Accessoires à la page 100

Optionals pag.107 ↑

# AMM AMMC ATT

Quadro elettromeccanico per avviamento diretto 1 motore monofase o trifase

Electromechanical panel for direct start-up of 1 single or three phase motor

Coffret électromécanique pour le démarrage direct de 1 moteur monophasée ou triphasée

0,37 → 2,2 kW



## SERIE AMM AMMC ATT

- Compatto ed economico
- Ingresso per comando di marcia
- Condensatore di marcia
- Protezione termica sovraccarico ripristinabile esternamente

### AMM

- Interruttore generale bipolare luminoso 0-1

### AMMC

- Interruttore generale bipolare a camme 0-1
- Spia LED verde di motore in funzione

### ATT

- Pulsante START e STOP motore
- Contattore di linea in AC3

## AMM AMMC ATT SERIES

- Compact and economical
- Input for start command
- Starting capacitor
- Thermal protection with external reset switch

### AMM

- Luminous main switch 0-1

### AMMC

- Sélecteur lumineux 0-1
- Green led for motor operating

### ATT

- START and STOP motor pushbuttons
- Line contactor AC3

## SÉRIE AMM AMMC ATT

- Compact et économique
- Entrée pour command de démarrage
- Condenseur de démarrage
- Protection thermique de surcharge à rétablissement extérieur

### AMM

- Sélecteur lumineux 0-1

### AMMC

- Interrupteur à cammes 0-1
- LED vert de moteur en fonction

### ATT

- Boutons START et STOP moteur
- Contacteur de ligne AC3

# AMM AMMC ATT



## APPLICAZIONI TIPICHE / STANDARD APPLICATIONS / APPLICATIONS TYPIQUES

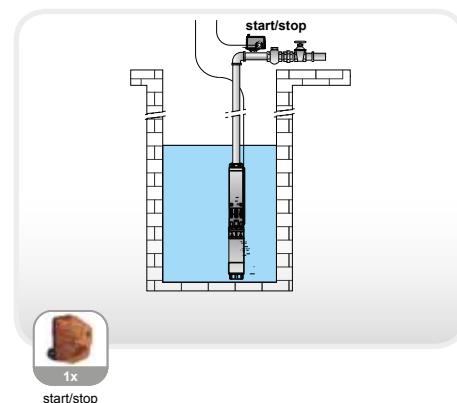
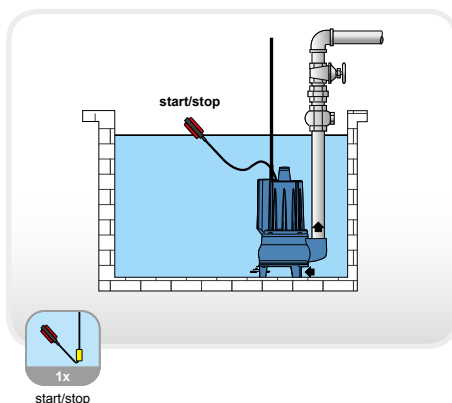
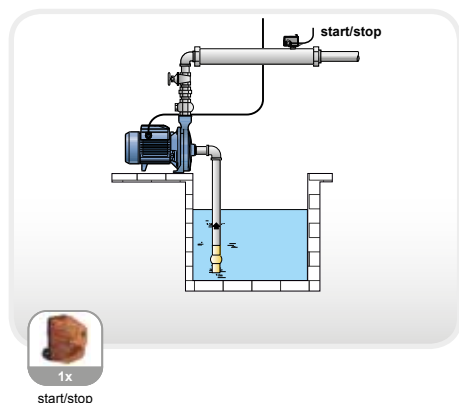

**1** Quadro elettrico per n.1 motore  
Control panel for n.1 motore  
Coffret électronique pour n.1 moteur

V	COD.	MODELLO / MODEL	POTENZA / POWER		PROTEZIONE / PROTECTION	COND. / CAPAC.	L x W x H			kg	box
			kW	Hp	termica / thermal A		H mm	L mm	W mm		
50/60 Hz						µF					
1~230V	200.01	AMM1/0,5	0,37	0,5	4	16	210	120	85	0,6	ABS
	200.02	AMM1/0,5	0,37	0,5	4	20	210	120	85	0,6	ABS
	200.03	AMM1/0,5	0,37	0,5	4	25	210	120	85	0,6	ABS
	200.04	AMM1/0,75	0,55	0,75	6	20	210	120	85	0,6	ABS
	200.05	AMM1/0,75	0,55	0,75	6	25	210	120	85	0,6	ABS
	200.06	AMM1/0,75	0,55	0,75	6	30	210	120	85	0,6	ABS
	200.07	AMM1/1	0,75	1	8	25	210	120	85	0,6	ABS
	200.08	AMM1/1	0,75	1	8	30	210	120	85	0,6	ABS
	200.09	AMM1/1	0,75	1	8	35	210	120	85	0,6	ABS
	200.10	AMM1/1,5	1,1	1,5	10	35	210	120	85	0,6	ABS
	200.11	AMM1/1,5	1,1	1,5	10	40	210	120	85	0,6	ABS
	200.12	AMM1/1,5	1,1	1,5	10	45	210	120	85	0,6	ABS
	200.13	AMM1/2	1,5	2	16	40	210	120	85	0,6	ABS
	200.14	AMM1/2	1,5	2	16	45	210	120	85	0,6	ABS
	200.15	AMM1/2	1,5	2	16	50	210	120	85	0,6	ABS
	200.16	AMM1/3	2,2	3	18	70	210	120	85	0,6	ABS
	200.17	AMM1/3	2,2	3	18	75	210	120	85	0,6	ABS
	200.18	AMM1/3	2,2	3	18	80	210	120	85	0,6	ABS
1~230V	210.01	AMM/C -0,5	0,37	0,5	4	16	160	150	80	0,8	ABS
	210.02	AMM/C -0,5	0,37	0,5	4	20	160	150	80	0,8	ABS
	210.03	AMM/C -0,5	0,37	0,5	4	25	160	150	80	0,8	ABS
	210.04	AMM/C -0,75	0,55	0,75	6	20	160	150	80	0,8	ABS
	210.05	AMM/C -0,75	0,55	0,75	6	25	160	150	80	0,8	ABS
	210.06	AMM/C -0,75	0,55	0,75	6	30	160	150	80	0,8	ABS
	210.07	AMM/C -1	0,75	1	8	25	160	150	80	0,8	ABS
	210.08	AMM/C -1	0,75	1	8	30	160	150	80	0,8	ABS
	210.09	AMM/C -1	0,75	1	8	35	160	150	80	0,8	ABS
	210.10	AMM/C -1,5	1,1	1,5	10	35	160	150	80	0,8	ABS
	210.11	AMM/C -1,5	1,1	1,5	10	40	160	150	80	0,8	ABS
	210.12	AMM/C -1,5	1,1	1,5	10	45	160	150	80	0,8	ABS
	210.13	AMM/C -2	1,5	2	16	40	160	150	80	0,8	ABS
	210.14	AMM/C -2	1,5	2	16	45	160	150	80	0,8	ABS
	210.15	AMM/C -2	1,5	2	16	50	160	150	80	0,8	ABS
	210.16	AMM/C -3	2,2	3	18	70	160	150	80	0,8	ABS
	210.17	AMM/C -3	2,2	3	18	75	160	150	80	0,8	ABS
	210.18	AMM/C -3	2,2	3	18	80	160	150	80	0,8	ABS
V	COD.	MODELLO / MODEL	CORRENTE / CURRENT			L x W x H			kg	box	
50/60 Hz			Nx [range] A			H mm	L mm	W mm			
3~400V	005.01	ATT/0.5	1x [0,9÷1,5]			184	88	140	0,8	ABS	
	005.02	ATT/0.75	1x [1,4÷2,3]			184	88	140	0,8	ABS	
	005.03	ATT/1.5	1x [2÷3,3]			184	88	140	0,8	ABS	
	005.04	ATT/2	1x [3÷5]			184	88	140	0,8	ABS	
	005.05	ATT/3	1x [4,5÷7,5]			184	88	140	0,8	ABS	
	005.06	ATT/5.5	1x [6÷10]			184	88	140	0,8	ABS	
	005.07	ATT/7.5	1x [9÷14]			184	88	140	1	ABS	
	005.08	ATT/10	1x [13÷18]			184	88	140	1	ABS	

# DEEP 1

**Quadro elettromeccanico per avviamento diretto di 1 motore monofase o trifase**

Electromechanical panel for direct start-up of 1 single or three phase motor

Coffret électromécanique pour le démarrage direct de 1 moteur monophasée ou triphasée

**0,37 → 11 kW**



## SERIE DEEP 1

- Fusibili di protezione
- Trasformatore 400/24V per circuiti ausiliari (solo DEEP-T)
- 1 Ingresso per comando di marcia
- 1 ingresso per comando di arresto minimo livello
- Selettore AUTO-0-MAN
- Spia LED verde motore in funzione
- Spia LED rossa allarme motore in protezione
- Contattore di linea in AC3
- Relé termico di sovraccarico ripristinabile internamente

## DEEP 1 SERIES

- Protection fuses
- Transformer 400/24V for auxiliary circuits (DEEP-T only)
- 1 input for start command
- 1 input for stop command for minimum level
- Selector AUTO-0-MAN
- Green LED for motor operating
- Red LED for motor protection alarm
- Line contactor AC3
- Overload thermal relay internally restorable

## SÉRIE DEEP 1

- Fusibles de protection
- Transformateur 400/24V circuits auxiliaires (DEEP-T seulement)
- 1 entrée pour command de démarrage
- 1 entrée pour la commande d'arrêt niveau min.
- Sélecteur AUTO-0-MAN
- LED vert de moteur en fonction
- LED rouge d'alarme moteur en protection
- Contacteur de ligne AC3
- Relais thermique de surcharge à rétablissement manuel

# DEEP 1



## APPLICAZIONI TIPICHE / STANDARD APPLICATIONS / APPLICATIONS TYPIQUES

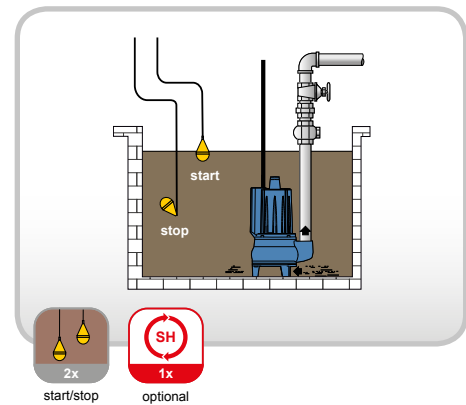
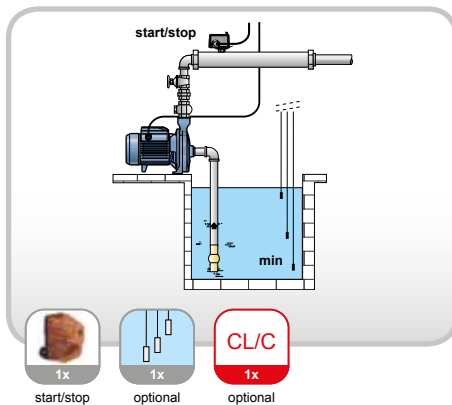
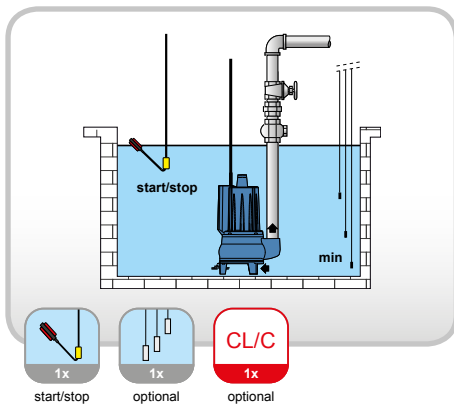
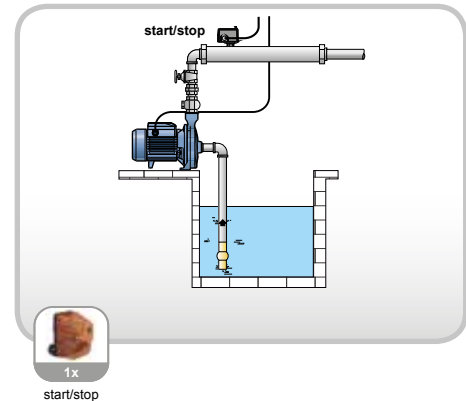
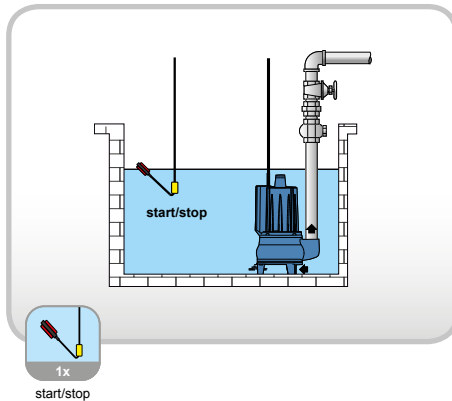
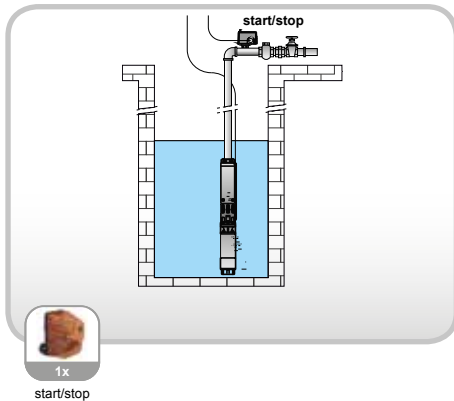

**Quadro elettrico per n.1 motore**  
Control panel for n.1 motor  
Coffret électronique pour n.1 moteur

V	COD.	MODELLO / MODEL	POTENZA / POWER		CORRENTE / CURRENT	TERMICA / THERM	L x W x H			kg	box
			kW	Hp			H mm	L mm	W mm		
50/60 Hz					Nx [range] A	[range] A					
1~230V	001.30	DEEP 1-M/0,5	0,37	0,5	1x [3÷4,5]	3÷5	340	240	170	3,5	ABS
	001.31	DEEP 1-M/0,75	0,55	0,75	1x [4,5 ÷6,5]	4,5÷7,5	340	240	170	3,5	ABS
	001.32	DEEP 1-M/1	0,75	1	1x [6÷9]	6÷10	340	240	170	3,5	ABS
	001.33	DEEP 1-M/1,5	1,1	1,5	1x [9÷10,5]	9÷15	340	240	170	3,5	ABS
	001.34	DEEP 1-M/2	1,5	2	1x [9÷13,5]	9÷15	340	240	170	3,5	ABS
	001.35	DEEP 1-M/3	2,2	3	1x [14÷18]	17÷23	340	240	170	3,5	ABS
3~400V	003.70	DEEP 1-T/0,5	0,37	0,5	1x [0,9 ÷1,3]	0,9÷1,5	340	240	170	3,5	ABS
	003.71	DEEP 1-T/0,75	0,55	0,75	1x [1,4 ÷2]	1,4÷2,3	340	240	170	3,5	ABS
	003.72	DEEP 1-T/1,5	0,75÷1,1	1÷1,5	1x [2÷3,2]	2÷3,3	340	240	170	3,5	ABS
	003.73	DEEP 1-T/2	1,5	2	1x [3÷4,5]	3-5	340	240	170	3,5	ABS
	003.74	DEEP 1-T/3	2,2	3	1x [4,5 ÷6,8]	4,5÷7,5	340	240	170	3,5	ABS
	003.75	DEEP 1-T/5,5	3 ÷ 4	4 ÷ 5,5	1x [6÷9]	6÷10	340	240	170	3,5	ABS
	003.76	DEEP 1-T/7,5	5,5	7,5	1x [9÷12]	9÷15	340	240	170	4	ABS
	003.77	DEEP 1-T/10	7,5	10	1x [10÷16]	13÷18	340	240	170	4	ABS
003.78	DEEP 1-T/15	11	15	1x [15÷20]	17÷23	340	240	170	4,5	ABS	

# DEEP 2

**Quadro elettromeccanico per avviamento diretto di 2 motori monofase o trifasi**

Electromechanical panel for direct start-up of 1 single or three phase motors

Coffret électromécanique pour le démarrage direct de 2 moteurs monophasée ou triphasée

**0,37 → 11 kW**



## SERIE DEEP 2

- Fusibili di protezione
- Trasformatore 400/24V per circuiti ausiliari (solo DEEP-T)
- 2 ingressi per comando di marcia
- 2 ingressi per comando di arresto minimo livello
- 2 selettori AUTO-0-MAN
- 2 spie LED verdi motori in funzione
- 2 spie LED rosse allarme motore in protezione
- 2 contattori di linea in AC3
- 2 Relé termici di sovraccarico ripristinabili internamente

## DEEP 2 SERIES

- Protection fuses
- Transformer 400/24V for auxiliary circuits (DEEP-T only)
- 2 inputs for start command
- 2 inputs for stop command for minimum level
- 2 selectors AUTO-0-MAN
- 2 green LED for motors operating
- 2 red LED for motors protection alarm
- 2 line contactors AC3
- 2 overload thermal relays internally restorable

## SÉRIE DEEP 2

- Fusibles de protection
- Transformateur 400/24V circuits auxiliaires (DEEP-T seulement)
- 2 entrées pour command de démarrage
- 2 entrées pour la commande d'arrêt niveau min.
- 2 sélecteur AUTO-0-MAN
- 2 LED vert de moteurs en fonction
- 2 LED rouge d'alarme moteurs en protection
- 2 contacteurs de ligne AC3
- 2 relais thermique de surcharge à rétablissement manuel

# DEEP 2



## APPLICAZIONI TIPICHE / STANDARD APPLICATIONS / APPLICATIONS TYPIQUES

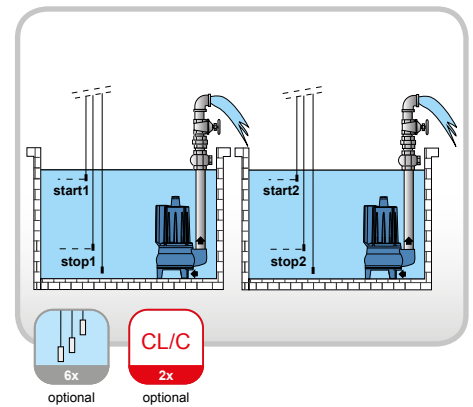
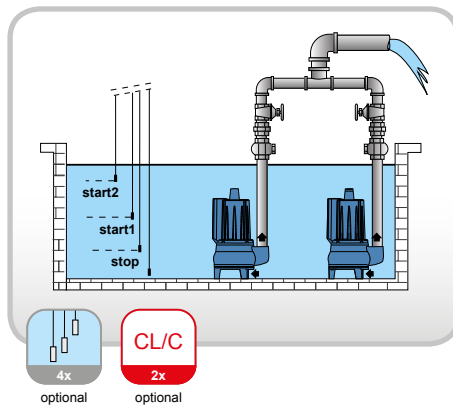
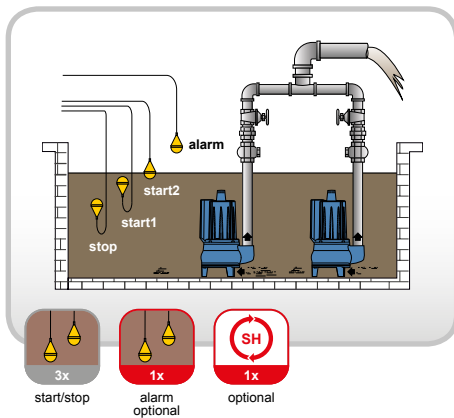
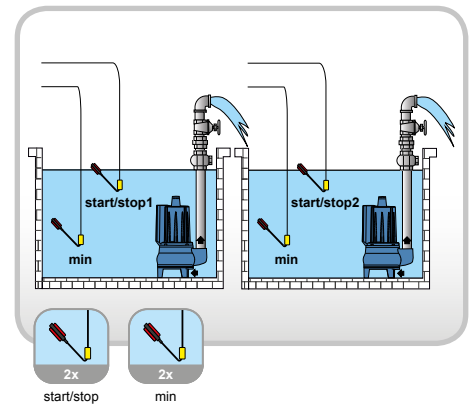
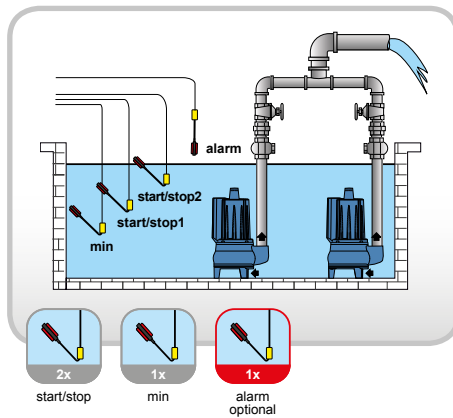
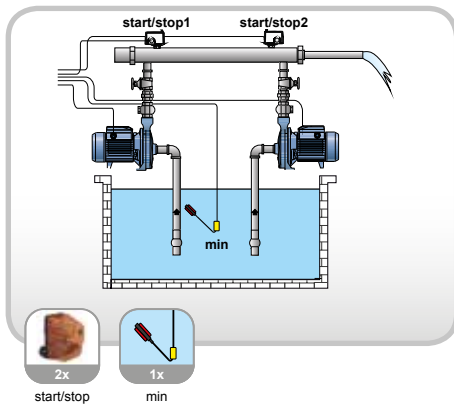

**Quadro elettrico per n.2 motori**  
Control panel for n.2 motors  
Coffret électronique pour n.2 moteurs

V	COD.	MODELLO / MODEL	POTENZA / POWER		CORRENTE / CURRENT	TERMICA / THERM	L <sub>W</sub>			kg	box
			kW	Hp			H mm	L mm	W mm		
50/60 Hz					Nx [range] A	[range] A					
1~230V	001.61	DEEP 2-M/0,5	0,37	0,5	2x [3.4÷5.5]	3÷5	420	300	150	7	ABS
	001.63	DEEP 2-M/0,75	0,55	0,75	2x [4.5÷6.5]	4,5÷7,5	420	300	150	7	ABS
	001.64	DEEP 2-M/1	0,55÷0,75	0,75÷1	2x [5.3÷8.5]	6÷10	420	300	150	7	ABS
	001.65	DEEP 2-M/1,5	1,1	1,5	2x [7.6÷12]	9÷15	420	300	150	7	ABS
	001.66	DEEP 2-M/2	1,5	2	2x [11÷15]	9÷15	420	300	150	8	ABS
	001.67	DEEP 2-M/3	2,2	3	2x [14÷19]	17÷23	420	300	150	8	ABS
3~400V	001.68	DEEP 2-T/0,5	0,37	0,5	2x [0.8÷1.3]	0,9÷1,5	420	300	150	7	ABS
	001.69	DEEP 2-T/0,75	0,55	0,75	2x [1.3÷2.1]	1,4÷2,3	420	300	150	7	ABS
	001.70	DEEP 2-T/1,5	0,75÷1,1	1÷1,5	2x [2.1÷3.4]	2÷3,3	420	300	150	7	ABS
	001.71	DEEP 2-T/2	1,5	2	2x [3.4÷5.5]	3÷5	420	300	150	7	ABS
	001.72	DEEP 2-T/3	2,2	3	2x [5.3÷8.5]	4,5÷7,5	420	300	150	7	ABS
	001.74	DEEP 2-T/5,5	4	5,5	2x [7.6÷12]	6÷10	420	300	150	7	ABS
	001.75	DEEP 2-T/7,5	5,5	7,5	2x [11÷15]	9÷15	420	300	150	8	ABS
	001.76	DEEP 2-T/10	7,5	10	2x [14÷19]	13÷18	420	300	150	8	ABS
	001.77	DEEP 2-T/15	11	15	2x [20÷27]	17÷23	530	400	230	14	METAL

# EDOL

**Quadro elettromeccanico per avviamento diretto di motori monofase o trifase**

Electromechanical panel for direct start-up of single or three phase motors

Coffret électromécanique à démarrage direct de moteurs monophasée ou triphasée

**0,37 → 75 kW**



## SERIE EDOL

- Sezionatore generale con bloccaporta
- Fusibili di protezione
- Trasformatore 230-400/24V per circuiti ausiliari
- 1 ingresso per comando di marcia
- 1 ingresso per comando di arresto minimo livello
- Selettore AUTO-0-MAN (man stabile)
- Spia LED blu presenza rete
- Spia LED verde motore in funzione
- Spia LED rossa allarme motore in protezione
- Contattore di linea in AC3
- Relé termico di sovraccarico ripristinabile internamente

### EDOL 2

- 2 ingressi per comando di marcia
- 2 ingressi per comando di arresto minimo livello
- 2 uscite motori: Contattori in AC3

### EDOL 3

- 3 ingressi per comando di marcia
- 3 ingressi per comando di arresto minimo livello
- 3 uscite Motori: Contattori in AC3

## EDOL SERIES

- Main switch with door interlock
- Protection fuses
- Transformer 230-400/24V for auxiliary circuits
- 1 input for start command
- 1 input for stop command for minimum level
- Selector AUTO-0-MAN (man stable)
- Blue LED for power on
- Green LED for motor operating
- Red LED for motor protection alarm
- Line contactor AC3
- Overload thermal relay internally restorable

### EDOL 2

- 2 inputs for start command
- 2 inputs for stop command for minimum level
- 2 outputs: Contactors in AC3

### EDOL 3

- 3 inputs for start command
- 3 inputs for stop command for minimum level
- 3 outputs: Contactors in AC3

## SÉRIE EDOL

- Sectionneur général avec verrouillage de porte
- Fusibles de protection
- Transformateur 230-400/24V circuits auxiliaires
- 1 entrée pour command de démarrage
- 1 entrée pour la commande d'arrêt niveau min.
- Sélecteur AUTO-0-MAN (manuel stable)
- LED bleu de présence réseau
- LED vert de moteur en fonction
- LED rouge d'alarme moteur en protection
- Contacteur de ligne AC3
- Relais thermique de surcharge à rétablissement manuel

### EDOL 2

- 2 entrées pour command de démarrage
- 2 entrées pour la commande d'arrêt niveau min.
- 2 sorties moteur: Contacteurs en AC3

### EDOL 3

- 3 entrées pour command de démarrage
- 3 entrées pour la commande d'arrêt niveau min.
- 3 sorties moteurs: Contacteurs en AC3



# EDOL 1



## APPLICAZIONI TIPICHE / STANDARD APPLICATIONS / APPLICATIONS TYPIQUES

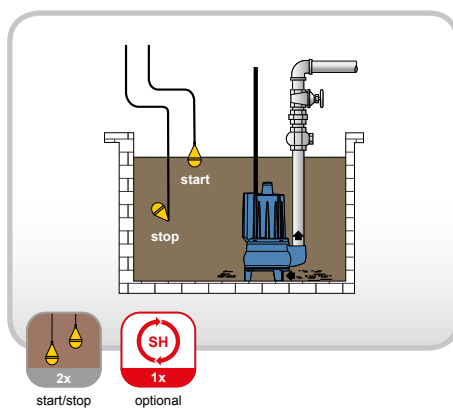
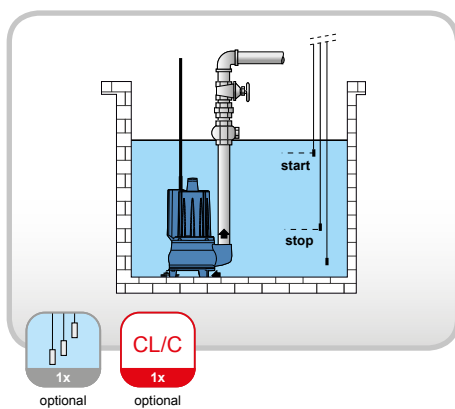
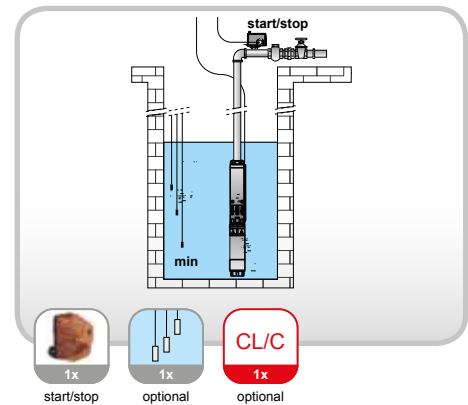
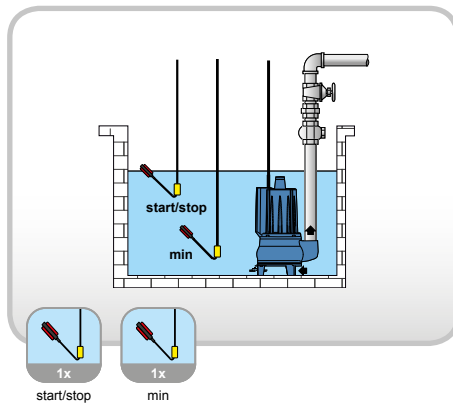
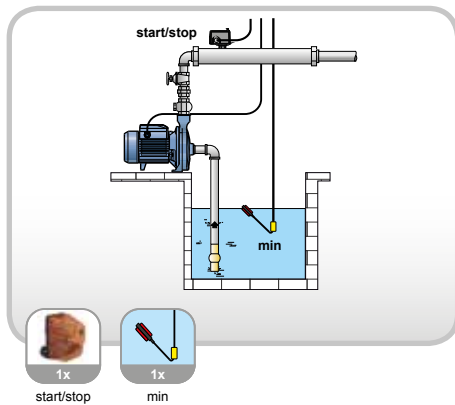

**Quadro elettrico per n.1 motore**  
Control panel for n.1 motor  
Coffret électronique pour n.1 moteur

V	COD.	MODELLO / MODEL	POTENZA / POWER		CORRENTE / CURRENT	TERMICA / THERM	L x W x H			kg	box
			kW	Hp			H mm	L mm	W mm		
50/60 Hz					Nx [range] A	[range] A					
1~230V	001.20	EDOL 1-M /0,5	0,37	0,5	1x [3.4÷5.5]	4÷6,5	340	240	170	4	ABS
	001.22	EDOL 1-M /1	0,55÷0,75	0,75÷1	1x [5.3÷8.5]	6,3÷10	340	240	170	4	ABS
	001.23	EDOL 1-M /1,5	1,1	1,5	1x [7.6÷12]	9÷14	340	240	170	5	ABS
	001.24	EDOL 1-M /2	1,5	2	1x [11÷15]	13÷18	340	240	170	5	ABS
	001.25	EDOL 1-M /3	2,2	3	1x [14÷19]	17÷23	340	240	170	5	ABS
3~400V	003.50	EDOL 1-T /0,5	0,37	0,5	1x [0.8÷1.3]	1÷1,6	340	240	170	4	ABS
	003.51	EDOL 1-T /0,75	0,55	0,75	1x [1.3÷2.1]	1,6÷2,5	340	240	170	4	ABS
	003.52	EDOL 1-T /1,5	0,75÷1,1	1÷1,5	1x [2.1÷3.4]	2,5÷4	340	240	170	4	ABS
	003.53	EDOL 1-T /2	1,5	2	1x [3.4÷5.5]	4÷6,5	340	240	170	4	ABS
	003.54	EDOL 1-T /3	2,2	3	1x [5.3÷8.5]	6,3÷10	340	240	170	4	ABS
	003.55	EDOL 1-T /5,5	4	5,5	1x [7.6÷12]	9 ÷ 14	340	240	170	5	ABS
	003.56	EDOL 1-T /7,5	5,5	7,5	1x [11÷15]	13 ÷ 18	340	240	170	5	ABS
	003.57	EDOL 1-T /10	7,5	10	1x [14÷19]	17÷23	340	240	170	5	ABS
	003.58	EDOL 1-T /12,5	9,2	12,5	1x [17÷21]	20÷25	340	240	170	6	ABS
	003.59	EDOL 1-T /15	11	15	1x [20÷27]	24÷32	420	300	150	12	ABS
	003.60	EDOL 1-T /20	15	20	1x [27÷32]	32÷38	420	300	150	12	ABS
	003.61	EDOL 1-T /25	18,5	25	1x [30÷42]	35÷50	530	400	230	15	METAL
	003.67	EDOL 1-T /35	22÷25,7	30÷35	1x [39÷55]	46÷65	530	400	230	15	METAL
	003.63	EDOL 1-T /40	30	40	1x [51÷69]	60÷82	530	400	230	15	METAL
	003.64	EDOL 1-T /50	37	50	1x [60÷80]	70÷95	530	400	230	15	METAL
003.65	EDOL 1-T /60	44	60	1x [77÷93]	90÷110	530	400	230	16	METAL	
003.66	EDOL 1-T /80	55÷59	75÷80	1x [77÷127]	90÷150	700	500	280	25	METAL	
003.68	EDOL 1-T /100	75	100	1x [102÷170]	120÷200	700	500	280	30	METAL	

# EDOL 2



## APPLICAZIONI TIPICHE / STANDARD APPLICATIONS / APPLICATIONS TYPIQUES

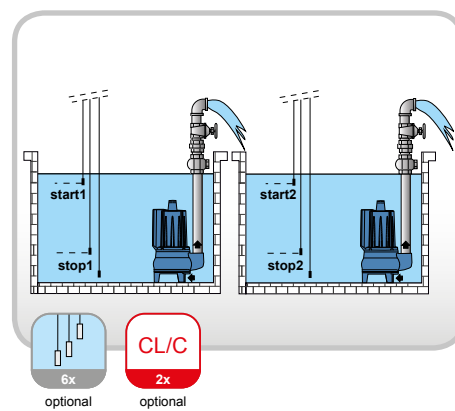
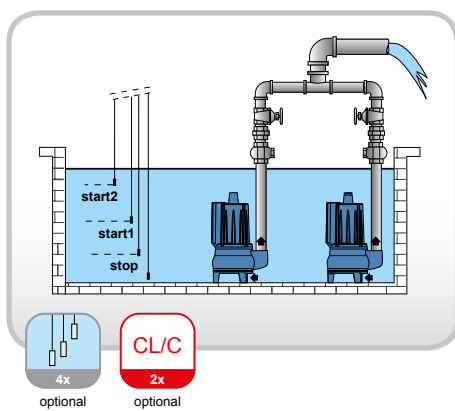
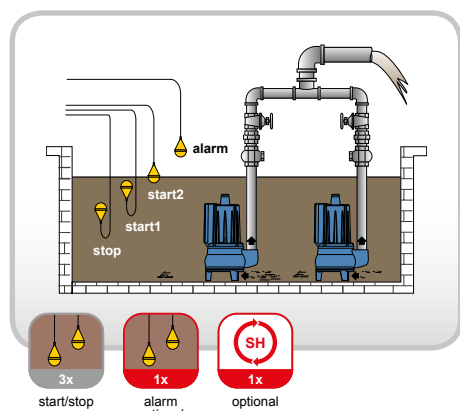
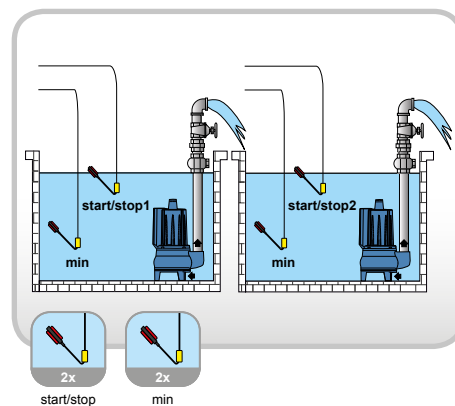
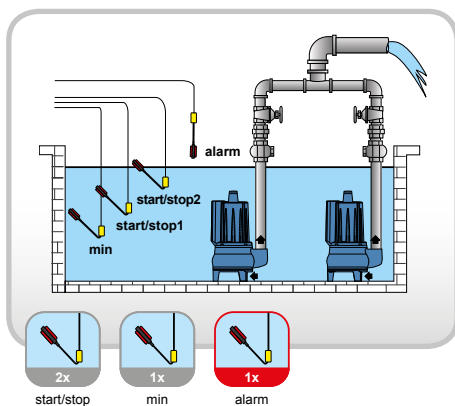
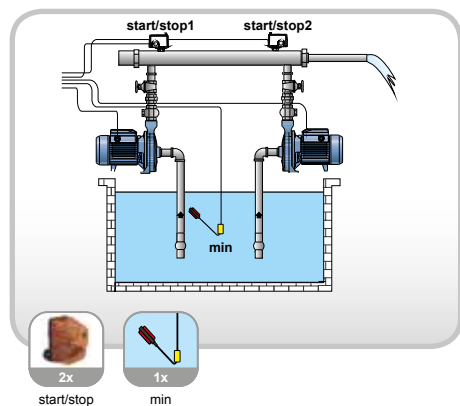

**Quadro elettrico per n.2 motori**  
Control panel for n.2 motors  
Coffret électronique pour n.2 moteurs

V	COD.	MODELLO / MODEL	POTENZA / POWER		CORRENTE / CURRENT	TERMICA / THERM	L x W x H			kg	box	
			kW	Hp			H mm	L mm	W mm			
50/60 Hz												
	1-230V	002.20	EDOL 2-M /0,5	0,37	0,5	2x [3.4÷5.5]	4÷6,5	420	300	150	7	ABS
		002.22	EDOL 2-M /1	0,55÷0,75	0,75÷1	2x [5.3÷8.5]	6,3÷10	420	300	150	7	ABS
		002.23	EDOL 2-M /1,5	1,1	1,5	2x [7.6÷12]	9÷14	420	300	150	7	ABS
		002.24	EDOL 2-M /2	1,5	2	2x [11÷15]	13÷18	420	300	150	8	ABS
002.25		EDOL 2-M /3	2,2	3	2x [14÷19]	17÷23	420	300	150	8	ABS	
3-400V	004.50	EDOL 2-T /0,5	0,37	0,5	2x [0.8÷1.3]	1÷1,6	420	300	150	7	ABS	
	004.51	EDOL 2-T /0,75	0,55	0,75	2x [1.3÷2.1]	1,6÷2,5	420	300	150	7	ABS	
	004.52	EDOL 2-T /1,5	0,75÷1,1	1÷1,5	2x [2.1÷3.4]	2,5÷4	420	300	150	7	ABS	
	004.53	EDOL 2-T /2	1,5	2	2x [3.4÷5.5]	4÷6,5	420	300	150	7	ABS	
	004.54	EDOL 2-T /3	2,2	3	2x [5.3÷8.5]	6,3÷10	420	300	150	7	ABS	
	004.55	EDOL 2-T /5,5	4	5,5	2x [7.6÷12]	9 ÷14	420	300	150	7	ABS	
	004.56	EDOL 2-T /7,5	5,5	7,5	2x [11÷15]	13 ÷18	420	300	150	8	ABS	
	004.57	EDOL 2-T /10	7,5	10	2x [14÷19]	17÷23	420	300	150	8	ABS	
	004.58	EDOL 2-T /12,5	9,2	12,5	2x [17÷21]	20÷25	420	300	150	14	ABS	
	004.59	EDOL 2-T /15	11	15	2x [20÷27]	24÷32	530	400	230	15	METAL	
	004.60	EDOL 2-T /20	15	20	2x [27÷32]	32÷38	530	400	230	15	METAL	
	004.61	EDOL 2-T /25	18,5	25	2x [30÷42]	35÷50	530	400	230	15	METAL	
	004.65	EDOL 2-T /35	22÷25,7	30÷35	2x [39÷55]	46÷65	700	500	280	30	METAL	
	004.66	EDOL 2-T /40	30	40	2x [51÷69]	60÷82	700	500	280	30	METAL	
	004.67	EDOL 2-T /50	37	50	2x [60÷80]	70÷95	800	600	330	30	METAL	
	004.68	EDOL 2-T /60	44	60	2x [77÷93]	90÷110	800	600	330	32	METAL	
	004.69	EDOL 2-T /80	55÷59	75÷80	2x [77÷127]	90÷150	1000	800	330	50	METAL	
004.70	EDOL 2-T /100	75	100	2x [102÷170]	120÷200	1000	800	330	60	METAL		

- 2 ingressi per comando di marcia
- 2 ingressi per comando di minima
- 2 uscite motori: Contattori in AC3

- 2 inputs for start command
- 2 inputs for "minimum" contact
- 2 outputs: Contactors in AC3

- 2 entrées pour command de démarrage
- 2 entrées pour command de minimum
- 2 sorties moteurs: Contacteurs en AC3

# EDOL 3

IP 55

+40°  
-5°  
°C

50%  
@ 40°C

## APPLICAZIONI TIPICHE / STANDARD APPLICATIONS / APPLICATIONS TYPIQUES

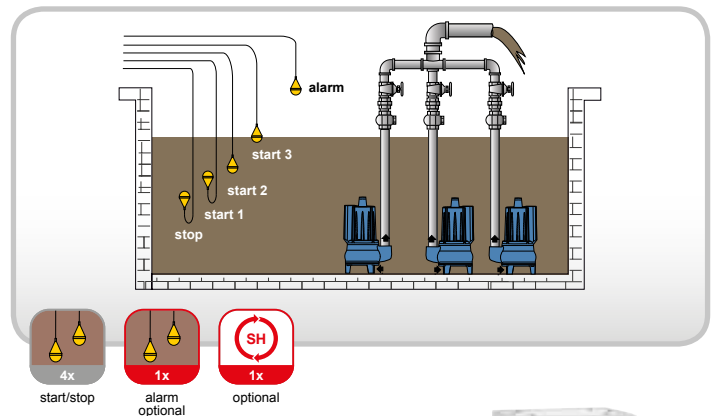
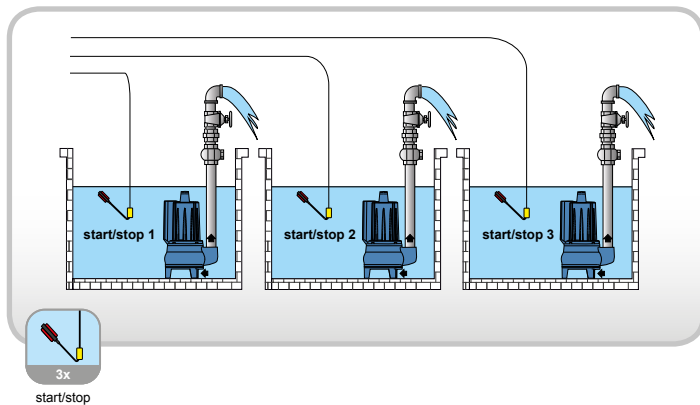
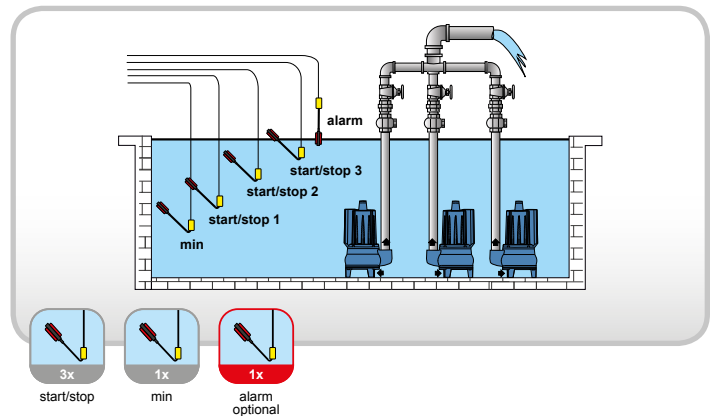
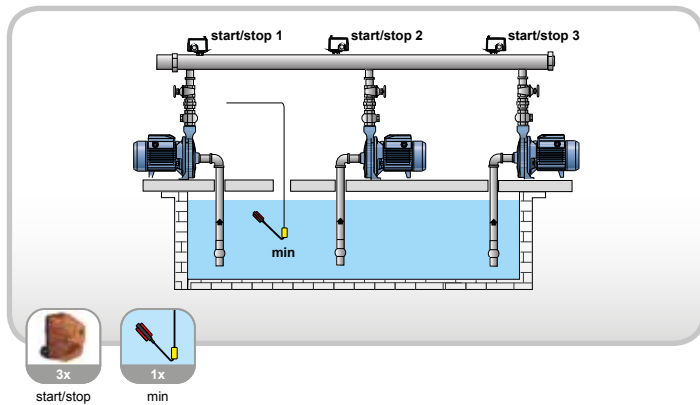

**Quadro elettrico per n.3 motori**  
Control panel for n.3 motors  
Coffret électronique pour n.3 moteurs

V	COD.	MODELLO / MODEL	POTENZA / POWER		CORRENTE / CURRENT	TERMICA / THERM	L x W x H			kg	box
			kW	Hp			H mm	L mm	W mm		
50/60 Hz					Nx [range] A	[range] A					
1~230V	040.40	EDOL 3-M /0,5	0,37	0,5	3x [3.4÷5.5]	4÷6,5	530	400	230	8	METAL
	040.42	EDOL 3-M /1	0,55÷0,75	0,75÷1	3x [5.3÷8.5]	6,3÷10	530	400	230	14	METAL
	040.43	EDOL 3-M /1,5	1,1	1,5	3x [7.6÷12]	9÷14	530	400	230	14	METAL
3~400V	040.50	EDOL 3-T /0,5	0,37	0,5	3x [0.8÷1.3]	1÷1,6	530	400	230	14	METAL
	040.51	EDOL 3-T /0,75	0,55	0,75	3x [1.3÷2.1]	1,6÷2,5	530	400	230	14	METAL
	040.52	EDOL 3-T /1,5	0,75÷1,1	1÷1,5	3x [2.1÷3.4]	2,5÷4	530	400	230	14	METAL
	040.53	EDOL 3-T /2	1,5	2	3x [3.4÷5.5]	4÷6,5	530	400	230	14	METAL
	040.54	EDOL 3-T /3	2,2	3	3x [5.3÷8.5]	6,3÷10	530	400	230	14	METAL
	040.55	EDOL 3-T /5,5	4	5,5	3x [7.6÷12]	9 ÷ 14	530	400	230	14	METAL
	040.56	EDOL 3-T /7,5	5,5	7,5	3x [11÷15]	13 ÷ 18	530	400	230	14	METAL
	040.57	EDOL 3-T /10	7,5	10	3x [14÷19]	17÷23	640	400	230	15	METAL
	040.68	EDOL 3-T /12,5	9,2	12,5	3x [17÷21]	20÷25	640	400	230	15	METAL
	040.58	EDOL 3-T /15	11	15	3x [20÷27]	24÷32	640	400	230	15	METAL
	040.59	EDOL 3-T /20	15	20	3x [27÷32]	32÷38	800	600	330	23	METAL
	040.60	EDOL 3-T /25	18,5	25	3x [30÷42]	35÷50	800	600	330	23	METAL
	040.69	EDOL 3-T /35	22÷25,7	30÷35	2x [39÷55]	46÷65	800	600	330	45	METAL
	040.62	EDOL 3-T /40	30	40	3x [51÷69]	60÷82	1000	800	330	45	METAL
	040.63	EDOL 3-T /50	37	50	3x [60÷80]	70÷95	1000	800	330	45	METAL
040.65	EDOL 3-T /60	44	60	3x [77÷93]	90÷110	1000	800	330	50	METAL	
040.66	EDOL 3-T /80	55÷59	75÷80	3x [77÷127]	90÷150	1200	800	330	75	METAL	
040.67	EDOL 3-T /100	75	100	3x [102÷170]	120÷200	1200	800	330	90	METAL	

- 3 ingressi per comando di marcia
- 3 ingressi per comando di minima
- 3 uscite Motori: Contattori in AC3

- 3 inputs for start command
- 3 inputs for "minimum" contact
- 3 outputs: Contactors in AC3

- 3 entrées pour command de démarrage
- 3 entrées pour command de minimum
- 3 sorties moteurs: Contacteurs en AC3

# QAR-E 1

Quadro elettromeccanico per avviamento diretto di 1 motore monofase o trifase

Electromechanical panel for direct start-up of 1 single or three phase motor

Coffret électromécanique à démarrage direct de 1 moteur monophasée ou triphasée

0,37 → 18,5 kW



## SERIE QAR-E 1

- Sezionatore generale con bloccaporta
- Fusibili di protezione
- Trasformatore 230-400/24V per circuiti ausiliari
- 1 ingressi per comando di marcia
- 1 ingresso per comando di arresto
- 1 ingresso per comando di allarme
- 1 ingressi per klixon motori
- 1 selettore AUTO-O-MAN (manuale stabile)
- Spia LED verde motore in funzione
- Spia LED rossa allarme motore in protezione
- Kit voltmetro con commutatore, amperometro e contaore per ogni motore
- Contattore di linea in AC3
- Relé termico di sovraccarico ripristinabile internamente
- Uscita allarme (contatti puliti NC-C-NA)
- Predisposizione per condensatore di marcia
- Autoritenuta

## QAR-E 1 SERIES

- Main switch with door interlock
- Protection fuses
- Transformer 230-400/24V for auxiliary circuits
- 1 inputs for start command
- 1 inputs for stop command
- 1 input for alarm
- 1 inputs for motors klixon
- 1 selector for AUTO-O-MAN (manual stable)
- Green LED for motor operating
- Red LED for motor protection alarm
- Voltmeter with selector, ammeter and hourcounter for each motor
- Line contactor AC3
- Thermal overload relays internally restorable
- Alarm output (volt free contact NO-COM-NC)
- Adapted for the insertion of capacitors
- Self-retaining

## SÉRIE QAR-E 1

- Sectionneur général avec verrouillage de porte
- Fusibles de protection
- Transformateur 230-400/24V circuits auxiliaires
- 1 entrées pour command de démarrage d'arrêt
- 1 entrée pour command d'arrêt
- 1 entrée pour command d'allarme
- 1 entrées pour klixon moteurs
- 1 sélecteur AUTO-O-MAN (manuel stable)
- LED vert de moteur en fonction
- LED rouge d'allarme moteur en protection
- Voltmètre avec sélecteur voltométrique, ampèremètre, compteurs horaires pour chaque moteur
- Contacteur de ligne AC3
- Relais thermique de surcharge à rétablissement interne
- Sortie allarme (NO-COM-NC volts sans contact)
- Predispositions condensateur de démarrage
- Automaintien

# QAR-E 1



## APPLICAZIONI TIPICHE / STANDARD APPLICATIONS / APPLICATIONS TYPIQUES

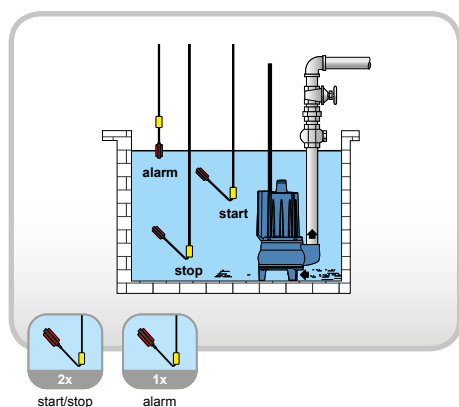
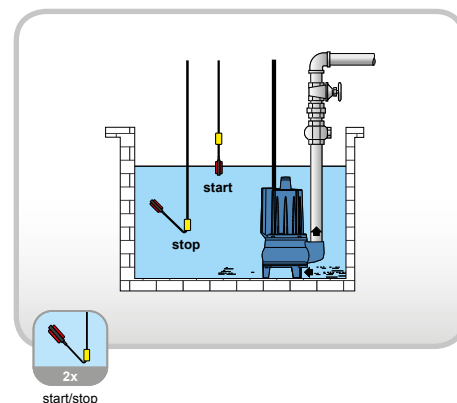
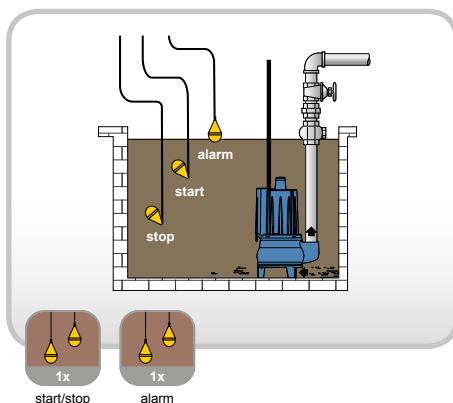
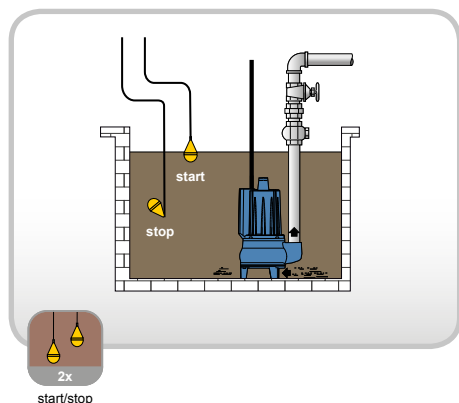

**Quadro elettrico per n.1 motore**  
Control panel for n.1 motor  
Coffret électronique pour n.1 moteur

V	COD.	MODELLO / MODEL	POTENZA / POWER		CORRENTE / CURRENT	L x W x H			kg	box
			kW	Hp		H mm	L mm	W mm		
50/60 Hz					Nx [range] A					
1~230V	010.40	QAR-E 1-M /0,5	0,37	0,5	1x [3.4÷5.5]	460	325	240	7	ABS
	010.42	QAR-E 1-M /1	0,55÷0,75	0,75÷1	1x [5.3÷8.5]	460	325	240	7	ABS
	010.43	QAR-E 1-M /1,5	1,1	1,5	1x [7.6÷12]	460	325	240	8	ABS
	010.44	QAR-E 1-M /2	1,5	2	1x [11÷15]	460	325	240	8	ABS
	010.45	QAR-E 1-M /3	2,2	3	1x [14÷19]	460	325	240	9	ABS
	010.64	QAR-E 1-M /4	3	4	1x [17÷21]	460	325	240	9	ABS
	010.65	QAR-E 1-M /5,5	4	5,5	1x [20÷27]	540	430	240	11	ABS
3~400V	010.46	QAR-E 1-T /0,5	0,37	0,5	1x [0.8÷1.3]	460	325	240	7	ABS
	010.47	QAR-E 1-T /0,75	0,55	0,75	1x [1.3÷2.1]	460	325	240	7	ABS
	010.48	QAR-E 1-T /1,5	0,75÷1,1	1÷1,5	1x [2.1÷3.4]	460	325	240	7	ABS
	010.49	QAR-E 1-T /2	1,5	2	1x [3.4÷5.5]	460	325	240	7	ABS
	010.50	QAR-E 1-T /3	2,2	3	1x [5.3÷8.5]	460	325	240	7	ABS
	010.51	QAR-E 1-T /5,5	4	5,5	1x [7.6÷12]	460	325	240	7	ABS
	010.52	QAR-E 1-T /7,5	5,5	7,5	1x [11÷15]	460	325	240	8	ABS
	010.53	QAR-E 1-T /10	7,5	10	1x [14÷19]	460	325	240	8	ABS
	010.66	QAR-E 1-T /12,5	9,2	12,5	1x [17÷21]	460	325	240	11	ABS
	010.54	QAR-E 1-T /15	11	15	1x [20÷27]	540	430	240	12	ABS
	010.55	QAR-E 1-T /20	15	20	1x [27÷32]	540	430	240	12	ABS
	010.56	QAR-E 1-T /25	18,5	25	1x [30÷42]	540	430	240	12	ABS

# QAR-E 2

Quadro elettromeccanico per avviamento diretto di 2 motori monofase o trifase

Electromechanical panel for direct start-up of 2 single or three phase motors

Coffret électromécanique à démarrage direct de 2 moteurs monophasée ou triphasée

0,37 → 18,5 kW



## SERIE QAR-E 2

- Sezionatore generale con bloccaporta
- Fusibili di protezione
- Trasformatore 230-400/24V per circuiti ausiliari
- 2 ingressi per comando di marcia
- 1 ingresso per comando di arresto
- 1 ingresso per comando di allarme
- 2 ingressi per klixon motori
- Circuito di alternanza/contemporaneità motori integrato
- 2 selettori AUTO-0-MAN (manuale stabile)
- 2 spie LED verdi motori in funzione
- 2 spie LED rosse allarme motori in protezione
- Kit voltmetro con commutatore, amperometro e contaore per ogni motore
- Contattori di linea in AC3
- Relé termici di sovraccarico ripristinabili internamente
- Uscita allarme (contatti puliti NC-C-NA)
- Predisposizione per condensatore di marcia
- Autoritenuta

## QAR-E 2 SERIES

- Main switch with door interlock
- Protection fuses
- Transformer 230-400/24V for auxiliary circuits
- 2 inputs for start command
- 1 inputs for stop command
- 1 input for alarm
- 2 inputs for motors klicson
- Motors exchanger circuit
- 2 selectors AUTO-0-MAN (manual stable)
- 2 green LED for motors operating
- 2 red LED for motors protection alarm
- Voltmeter with selector, ammeter and hourcounter for each motor
- Line contactors AC3
- Thermal overload relays internally restorable
- Alarm output (volt free contact NO-COM-NC)
- Adapted for the insertion of capacitors
- Self-retaining

## SÉRIE QAR-E 2

- Sectionneur général avec verrouillage de porte
- Fusibles de protection
- Transformateur 230-400/24V circuits auxiliaires
- 2 entrées pour command de démarrage d'arrêt
- 1 entrée pour command d'arrêt
- 1 entrée pour command d'alarme
- 2 entrées pour klicson moteurs
- Circuit d'échange moteurs
- 2 sélecteurs AUTO-0-MAN (manuel stable)
- 2 LED vert de moteurs en fonction
- 2 LED rouge d'alarme moteurs en protection
- Voltmètre avec sélecteur voltmétrique, ampèremètre, compteurs horaires pour chaque moteur
- Contacteurs de ligne AC3
- Relais thermique de surcharge à rétablissement interne
- Sortie alarme (NO-COM-NC volts sans contact)
- Prédispositions condensateur de démarrage
- Automaintien

# QAR-E 2



## APPLICAZIONI TIPICHE / STANDARD APPLICATIONS / APPLICATIONS TYPIQUES

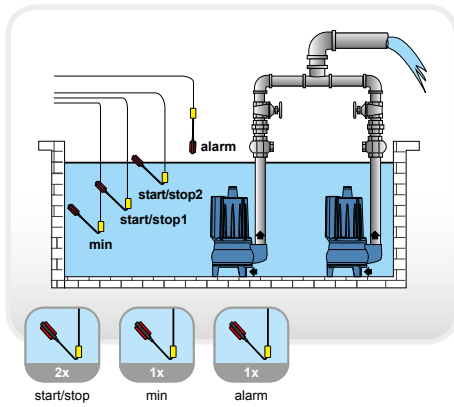
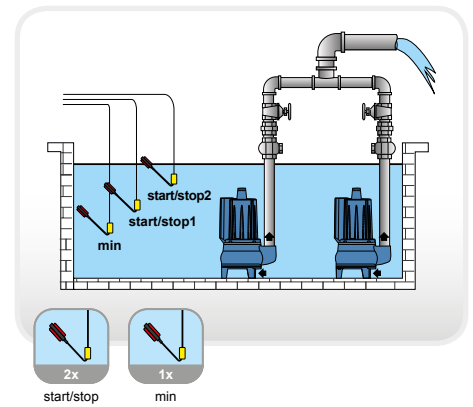
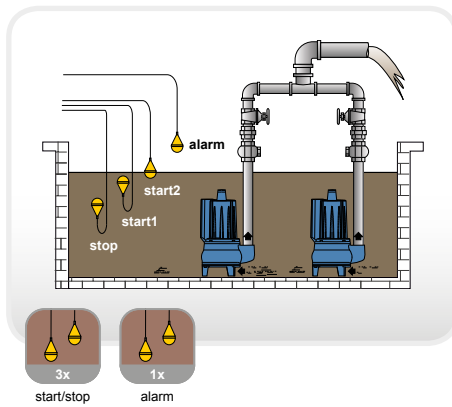
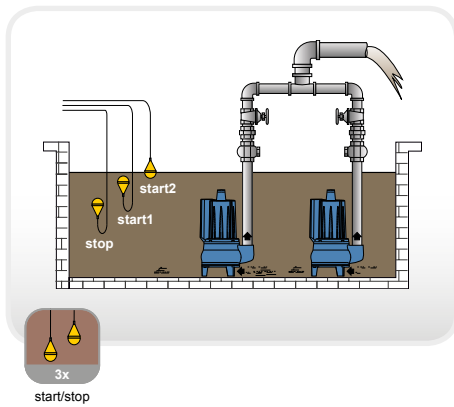

**Quadro elettrico per n.2 motori**  
Control panel for n.2 motors  
Coffret électronique pour n.2 moteurs

V	COD.	MODELLO / MODEL	POTENZA / POWER		CORRENTE / CURRENT	L x W x H			kg	box	
			kW	Hp		H mm	L mm	W mm			
50/60 Hz											
	1~230V	009.40	QAR-E 2-M /0,5	0,37	0,5	2x [3.4÷5.5]	540	430	240	12	ABS
		009.42	QAR-E 2-M /1	0,55÷0,75	0,75÷1	2x [5.3÷8.5]	540	430	240	12	ABS
		009.43	QAR-E 2-M /1,5	1,1	1,5	2x [7.6÷12]	540	430	240	12	ABS
		009.44	QAR-E 2-M /2	1,5	2	2x [11÷15]	540	430	240	12	ABS
		009.45	QAR-E 2-M /3	2,2	3	2x [14÷19]	540	430	240	12	ABS
		009.37	QAR-E 2-M /4	3	4	2x [17÷21]	540	430	240	12	ABS
009.38	QAR-E 2-M /5,5	4	5,5	2x [20÷27]	640	400	300	16	METAL		
3~400V	009.51	QAR-E 2-T /0,5	0,37	0,5	2x [0.8÷1.3]	540	430	240	12	ABS	
	009.52	QAR-E 2-T /0,75	0,55	0,75	2x [1.3÷2.1]	540	430	240	12	ABS	
	009.53	QAR-E 2-T /1,5	0,75÷1,1	1÷1,5	2x [2.1÷3.4]	540	430	240	12	ABS	
	009.54	QAR-E 2-T /2	1,5	2	2x [3.4÷5.5]	540	430	240	12	ABS	
	009.55	QAR-E 2-T /3	2,2	3	2x [5.3÷8.5]	540	430	240	12	ABS	
	009.56	QAR-E 2-T /5,5	4	5,5	2x [7.6÷12]	540	430	240	12	ABS	
	009.57	QAR-E 2-T /7,5	5,5	7,5	2x [11÷15]	540	430	240	12	ABS	
	009.58	QAR-E 2-T /10	7,5	10	2x [14÷19]	640	400	300	16	METAL	
	009.59	QAR-E 2-T /12,5	9,2	12,5	2x [17÷21]	640	400	300	16	METAL	
	009.60	QAR-E 2-T /15	11	15	2x [20÷27]	640	400	300	16	METAL	
	009.61	QAR-E 2-T /20	15	20	2x [27÷32]	640	400	300	16	METAL	
009.62	QAR-E 2-T /25	18,5	25	2x [30÷42]	740	500	300	18	METAL		

# DELTA

**Quadro elettromeccanico per avviamento stella-triangolo di motori trifase**

Electromechanical panel for star-delta start-up of three phase motors

Coffret électromécanique pour le démarrage étoile-triangle de moteurs triphasés

2,2 → 220 kW



## SERIE DELTA

- Sezionatore generale con bloccaporta
- Fusibili di protezione
- Trasformatore 230-400/24V per circuiti ausiliari
- 1 ingresso per comando di marcia
- 1 ingresso per comando di arresto minimo livello
- Selettore AUTO-0-MAN (manuale stabile)
- Spia LED blu presenza rete
- Spia LED verde motore in funzione
- Spia LED rossa allarme motore in protezione
- Contattori di linea/stella/triangolo in AC3
- Relé termico di sovraccarico ripristinabile internamente
- Temporizzatore scambio stella-triangolo 0÷30sec.

### DELTA 2

- 2 ingressi per comando di marcia
- 2 ingressi per comando di arresto minimo livello
- 2 uscite motori: Contattore in AC3

### DELTA 3

- 3 ingressi per comando di marcia
- 3 ingressi per comando di arresto minimo livello
- 3 uscite motori: Contattori in AC3

## DELTA SERIES

- Main switch with door interlock
- Protection fuses
- Transformer 230-400/24V for auxiliary circuits
- 1 input for start command
- 1 input for stop command for minimum level
- Selector AUTO-0-MANUAL (manual stable)
- Blue LED for power on
- Green LED for motor operating
- Red LED for motor protection alarm
- Line/star/delta contactors AC3
- Overload thermal relay internally restorable
- Timer for star/delta exchange 0÷30sec.

### DELTA 2

- 2 inputs for start command
- 2 inputs for stop command for minimum level
- 2 output motors: Contactors in AC3

### DELTA 3

- 3 inputs for start command
- 3 inputs for stop command for minimum level
- 3 outputs motors: Contactors in AC3

## SÉRIE DELTA

- Sectionneur général avec verrouillage de porte
- Fusibles de protection
- Transformateur 230-400/24V circuits auxiliaires
- 1 entrée pour command de démarrage
- 1 entrée pour la commande d'arrêt niveau min.
- Sélecteur AUTO-0-MAN (manuel stable)
- LED bleu de présence réseau
- LED vertes de moteur en fonction
- LED rouges d'alarme moteur en protection
- Contacteurs de ligne/étoile/triangle AC3
- Relais thermique de surcharge à rétablissement interne
- Temporisateur échange étoile-triangle 0÷30sec.

### DELTA 2

- 2 entrées pour command de démarrage
- 2 entrées pour la commande d'arrêt niveau min.
- 2 sorties moteurs: Contacteurs en AC3

### DELTA 3

- 3 entrées pour command de démarrage
- 3 entrées pour la commande d'arrêt niveau min.
- 3 sorties moteurs: Contacteurs en AC3



# DELTA 1



## APPLICAZIONI TIPICHE / STANDARD APPLICATIONS / APPLICATIONS TYPIQUES

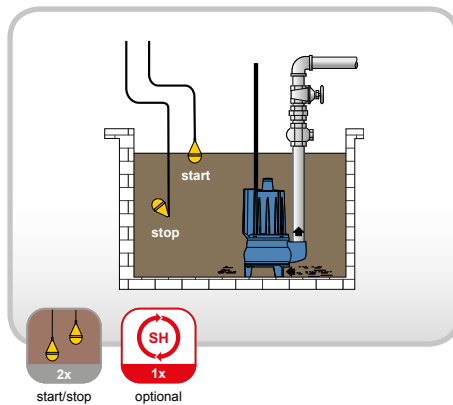
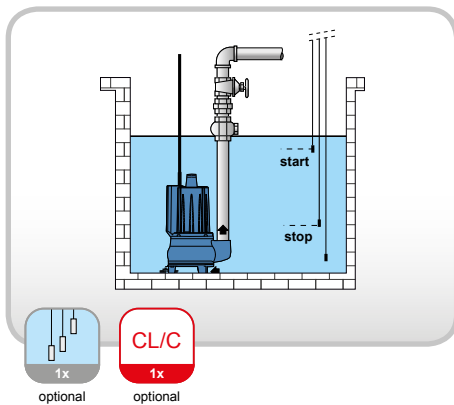
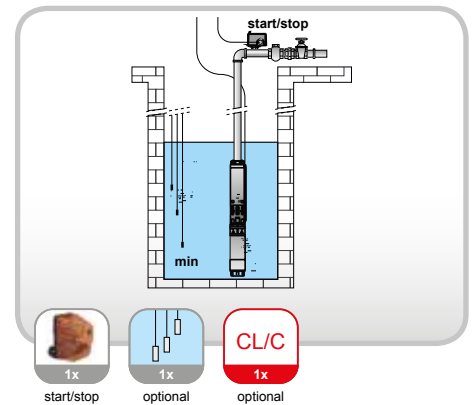
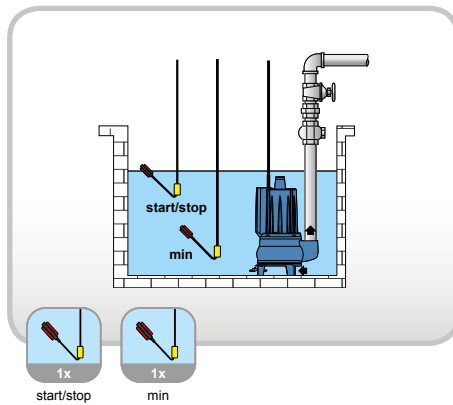
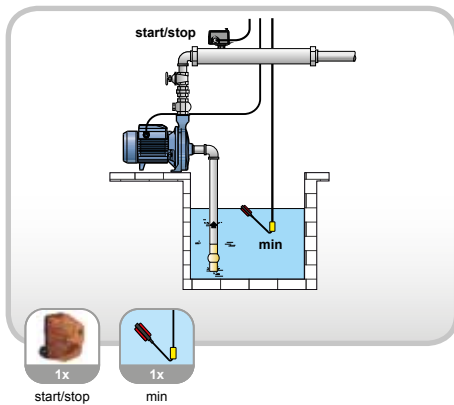

**Quadro elettrico per n.1 motore**  
Control panel for n.1 motor  
Coffret électronique pour n.1 moteur

V	COD.	MODELLO / MODEL	POTENZA / POWER		CORRENTE / CURRENT	L x W x H			kg	box
			kW	Hp		H mm	L mm	W mm		
50/60 Hz					Nx [range] A					
3~400V	006.01	DELTA1/3	2,2	3	1x [5÷8]	420	320	170	6	ABS
	006.02	DELTA1/5,5	4	5,5	1x [8÷11,5]	420	320	170	6	ABS
	006.03	DELTA1/7,5	5,5	7,5	1x [10÷14]	420	320	170	6	ABS
	006.04	DELTA1/10	7,5	10	1x [10÷16]	420	320	170	6	ABS
	006.05	DELTA1/15	11	15	1x [15÷20]	420	320	170	6	ABS
	006.06	DELTA1/20	15	20	1x [24÷31]	530	400	230	16	METAL
	006.07	DELTA1/25	18,5	25	1x [24÷36]	530	400	230	16	METAL
	006.08	DELTA1/30	22	30	1x [34÷50]	530	400	230	16	METAL
	006.09	DELTA1/40	30	40	1x [48÷62]	530	400	230	20	METAL
	006.10	DELTA1/50	37	50	1x [60÷77]	630	400	230	30	METAL
	006.11	DELTA1/60	45	60	1x [79÷98]	730	500	280	30	METAL
	006.12	DELTA1/75	55	75	1x [93÷124]	730	500	280	40	METAL
	006.13	DELTA1/100	75	100	1x [125÷135]	730	500	230	40	METAL
	006.14	DELTA1/125	92	125	1x [125÷155]	840	600	330	65	METAL
	006.15	DELTA1/150	110	150	1x [130÷195]	1040	800	330	65	METAL
	006.16	DELTA1/180	132	180	1x [155÷241]	1040	800	330	70	METAL
	006.17	DELTA1/220	162	220	1x [210÷290]	1040	800	330	80	METAL
	006.18	DELTA1/300	220	300	1x [260÷410]	1240	800	330	100	METAL
	006.19	DELTA1/340	250	340	1x [310÷510]	1240	800	330	120	METAL

# DELTA 2

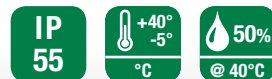

## APPLICAZIONI TIPICHE / STANDARD APPLICATIONS / APPLICATIONS TYPIQUES

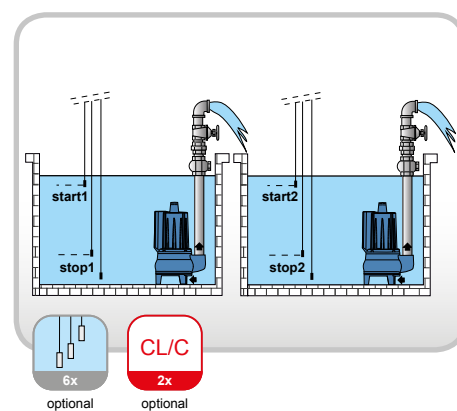
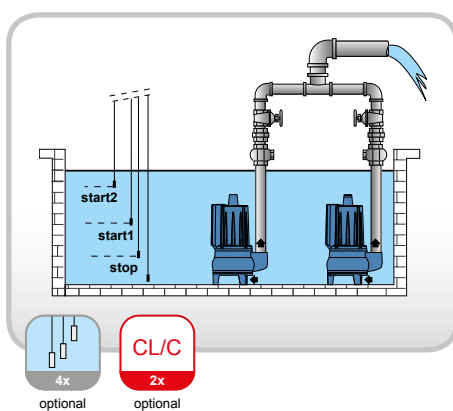
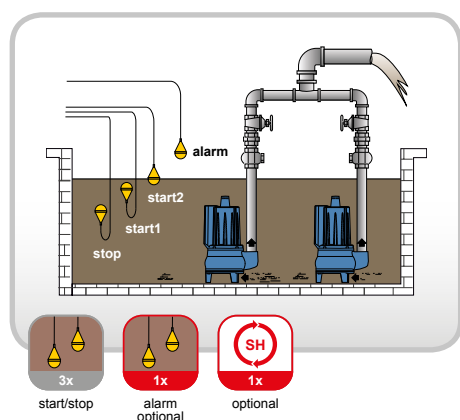
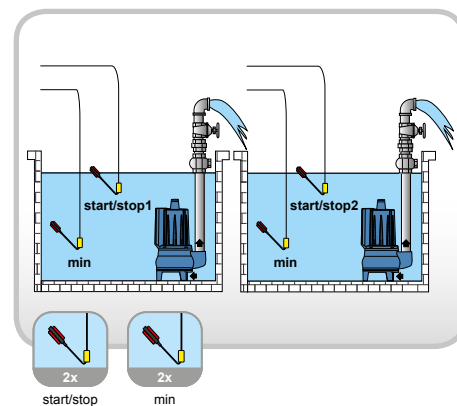
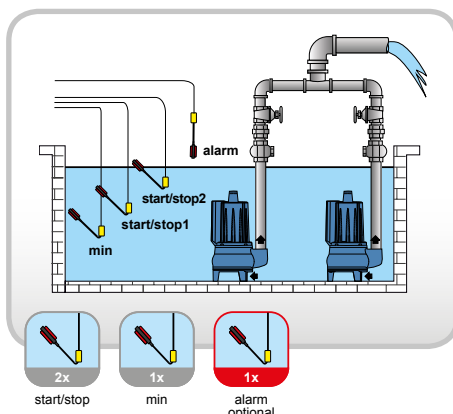
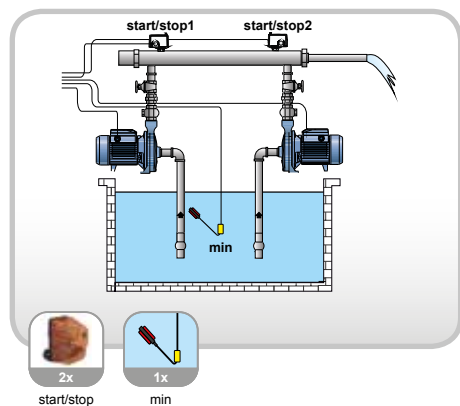

**Quadro elettrico per n.2 motori**  
Control panel for n.2 motors  
Coffret électronique pour n.2 moteurs

V	COD.	MODELLO / MODEL	POTENZA / POWER		CORRENTE / CURRENT	L x W x H			kg	box
			kW	Hp		H mm	L mm	W mm		
50/60 Hz	007.01	DELTA2/3	2,2	3	2x [5÷8]	630	400	230	12	METAL
	007.02	DELTA2/5,5	4	5,5	2x [8÷11,5]	630	400	230	12	METAL
	007.03	DELTA2/7,5	5,5	7,5	2x [10÷14]	630	400	230	12	METAL
	007.04	DELTA2/10	7,5	10	2x [10÷16]	630	400	230	12	METAL
	007.05	DELTA2/15	11	15	2x [15÷20]	630	400	230	12	METAL
	007.06	DELTA2/20	15	20	2x [24÷31]	690	500	230	32	METAL
	007.07	DELTA2/25	18,5	25	2x [24÷36]	740	500	230	40	METAL
	007.08	DELTA2/30	22	30	2x [34÷50]	740	500	230	40	METAL
	007.09	DELTA2/40	30	40	2x [48÷62]	840	600	330	60	METAL
	007.10	DELTA2/50	37	50	2x [60÷77]	1040	800	330	60	METAL
	007.11	DELTA2/60	45	60	2x [79÷98]	1040	800	330	80	METAL
	007.12	DELTA2/75	55	75	2x [93÷124]	1200	800	330	240	METAL
	007.13	DELTA2/100	75	100	2x [125÷135]	1400	800	330	260	METAL
	007.14	DELTA2/125	92	125	2x [125÷155]	1400	800	430	300	METAL
	007.15	DELTA2/150	110	150	2x [130÷195]	1600	1000	430	335	METAL
	007.16	DELTA2/180	132	180	2x [155÷241]	1800	1000	430	360	METAL
	007.17	DELTA2/220	162	220	2x [210÷290]	2000	1600	500	390	METAL
	007.18	DELTA2/300	220	300	2x [260÷410]	2000	1600	500	450	METAL

- 2 ingressi per comando di marcia
- 2 ingressi per comando di arresto minimo livello
- 2 uscite motori: Contattore in AC3

- 2 inputs for start command
- 2 inputs for stop command for minimum level
- 2 output motors: Contactors in AC3

- 2 entrées pour command de démarrage
- 2 entrées pour la commande d'arrêt niveau min.
- 2 sorties moteurs: Contacteurs en AC3

# DELTA 3

IP 55

+40°  
-5°  
°C

50%  
@ 40°C

## APPLICAZIONI TIPICHE / STANDARD APPLICATIONS / APPLICATIONS TYPIQUES

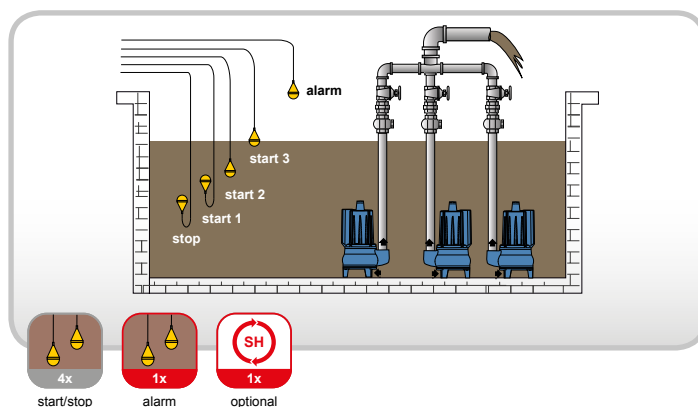
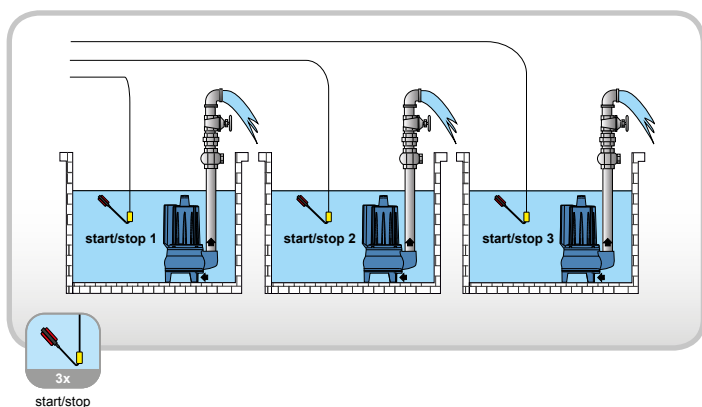
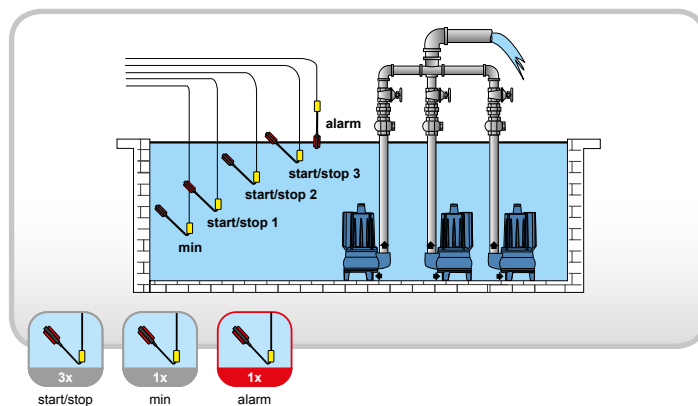
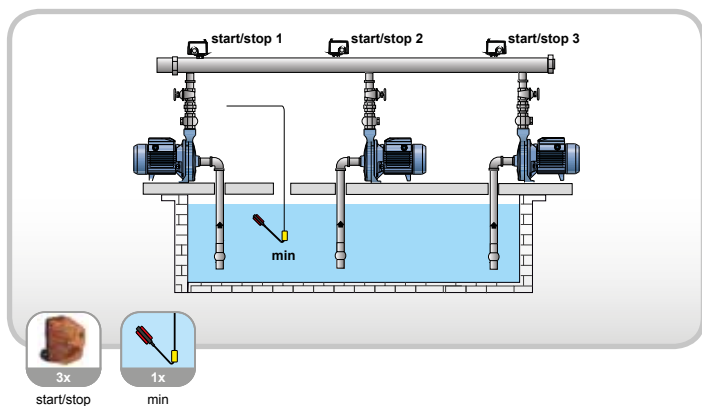

**Quadro elettrico per n.3 motori**  
Control panel for n.3 motors  
Coffret électronique pour n.3 moteurs

V	COD.	MODELLO / MODEL	POTENZA / POWER		CORRENTE / CURRENT	L x W x H			kg	box
			kW	Hp		H mm	L mm	W mm		
50/60 Hz					Nx [range] A					
3~400V	007.20	DELTA3/3	2,2	3	3x [5÷8]	740	500	230	12	METAL
	007.21	DELTA3/5,5	4	5,5	3x [8÷11,5]	740	500	230	12	METAL
	007.22	DELTA3/7,5	5,5	7,5	3x [10÷14]	740	500	230	12	METAL
	007.23	DELTA3/10	7,5	10	3x [10÷16]	740	500	230	12	METAL
	007.24	DELTA3/15	11	15	3x [15÷20]	740	500	230	12	METAL
	007.25	DELTA3/20	15	20	3x [24÷31]	740	500	230	32	METAL
	007.26	DELTA3/25	18,5	25	3x [24÷36]	840	600	280	40	METAL
	007.27	DELTA3/30	22	30	3x [34÷50]	840	600	280	40	METAL
	007.28	DELTA3/40	30	40	3x [48÷62]	1040	800	330	60	METAL
	007.29	DELTA3/50	37	50	3x [60÷77]	1040	800	330	70	METAL
	007.30	DELTA3/60	45	60	3x [79÷98]	1240	800	330	80	METAL
	007.31	DELTA3/75	55	75	3x [93÷124]	1800	1200	500	240	METAL
	007.32	DELTA3/100	75	100	3x [125÷135]	1800	1200	500	260	METAL
	007.33	DELTA3/125	92	125	3x [125÷155]	2000	1400	500	300	METAL
	007.34	DELTA3/150	110	150	3x [130÷195]	2000	1400	500	335	METAL
007.35	DELTA3/180	132	180	3x [155÷241]	2000	1600	500	360	METAL	
007.36	DELTA3/220	162	220	3x [210÷290]	2000	1600	500	390	METAL	
007.37	DELTA3/300	220	300	3x [260÷410]	2000	1600	500	450	METAL	

- 3 ingressi per comando di marcia
- 3 ingressi per comando di arresto minimo livello
- 3 uscite motori: Contattori in AC3

- 3 inputs for start command
- 3 inputs for stop command for minimum level
- 3 outputs motors: Contactors in AC3

- 3 entrées pour command de démarrage
- 3 entrées pour la commande d'arrêt niveau min.
- 3 sorties moteurs: Contacteurs en AC3

# STATOR

Quadro elettromeccanico per avviamento con impedenza di 1 motore trifase

Electromechanical panel for start-up with impedance of 1 three phase motor

Coffret électromécanique de démarrage avec impédance de 1 moteur triphasé

4 → 257 kW



## SERIE STATOR

- Sezionatore generale con bloccaporta
- Fusibili di protezione
- Trasformatore 230-400/24V per circuiti ausiliari
- 1 ingresso per comando di marcia
- 1 ingresso per comando di arresto minimo livello
- Selettore AUTO-0-MAN (manuale stabile)
- Spia LED blu presenza rete
- Spia LED verde motore in funzione
- Spia LED rossa allarme motore in protezione
- Contattori di linea/impedenza in AC3
- 4 manovre/ora di cui max. 2 consecutive
- Tempo di accelerazione 15 sec. max
- Relé termico di sovraccarico ripristinabile internamente
- Temporizzatore scambio impedenza 0÷30sec.

## STATOR SERIES

- Main switch with door interlock
- Protection fuses
- Transformer 230-400/24V for auxiliary circuits
- 1 input for start command
- 1 input for stop command for minimum level
- Selector AUTO-0-MAN (manual stable)
- Blue LED for power on
- Green LED for motor operating
- Red LED for motor protection alarm
- Line/impedance contactors AC3
- 4 start/h of which not more than 2 consecutively
- Acceleration time max 15 sec.
- Overload thermal relay internally restorable
- Timer for impedance exchange 0÷30sec.

## SÉRIE STATOR

- Sectionneur général avec verrouillage de porte
- Fusibles de protection
- Transformateur 230-400/24V circuits auxiliaires
- 1 entrée pour command de démarrage
- 1 entrée pour la commande d'arrêt niveau min.
- Sélecteur AUTO-0-MAN (manuel stable)
- LED bleu de présence réseau
- LED vert de moteur en fonction
- LED rouge d'alarme moteur en protection
- Contacteurs de ligne/impédance AC3
- 4 démarrages/h, pas plus que 2 consécutives
- Temps d'accélération max 15 sec.
- Relais thermique de surcharge à rétablissement interne
- Horloge pour échange d'impédance 0÷30sec.

# STATOR

IP 55

+40°  
-5°  
°C

50%  
@ 40°C

## APPLICAZIONI TIPICHE / STANDARD APPLICATIONS / APPLICATIONS TYPIQUES

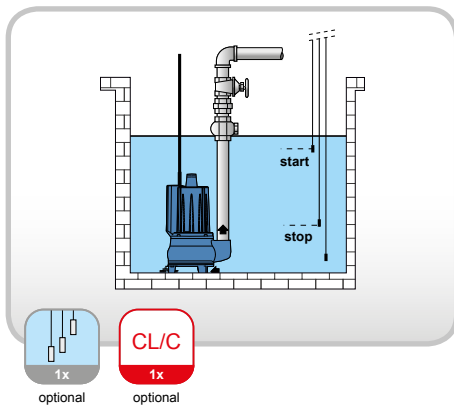
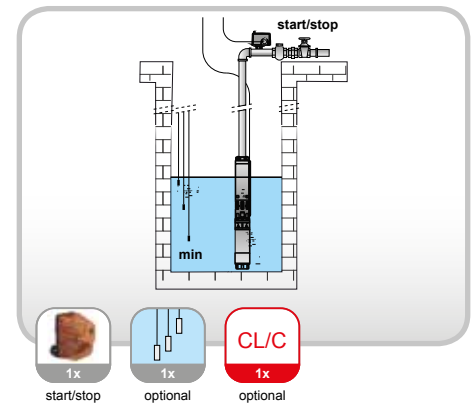
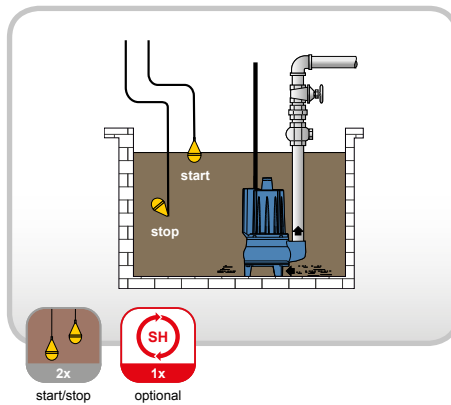
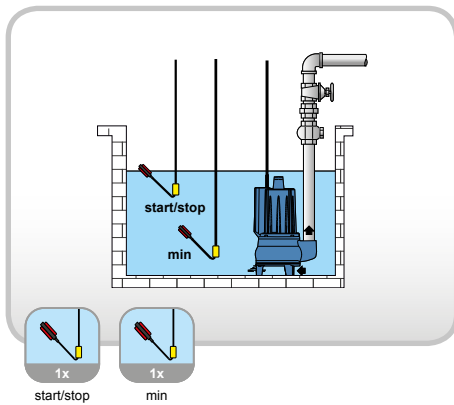

**Quadro elettrico per n.1 motore**  
Control panel for n.1 motor  
Coffret électronique pour n.1 moteur

V	COD.	MODELLO / MODEL	POTENZA / POWER		CORRENTE / CURRENT	L x W x H			kg	box
			kW	Hp		H mm	L mm	W mm		
50/60 Hz					Nx [range] A					
3~400V	008.01	STATOR /5,5	4	5,5	1x [7.6÷12]	530	400	230	19	METAL
	008.02	STATOR /7,5	5,5	7,5	1x [11÷15]	530	400	230	19	METAL
	008.03	STATOR /10	7,5	10	1x [14÷19]	530	400	230	21	METAL
	008.031	STATOR /12,5	9,2	12,5	1x [17÷21]	530	400	230	22	METAL
	008.04	STATOR /15	11	15	1x [20÷27]	530	400	230	22	METAL
	008.05	STATOR /20	15	20	1x [27÷32]	630	400	230	36	METAL
	008.06	STATOR /25	18,5	25	1x [30÷42]	630	400	230	36	METAL
	008.071	STATOR /35	22÷25,7	30÷35	1x [39÷55]	730	500	280	41	METAL
	008.08	STATOR /40	30	40	1x [51÷69]	730	500	280	43	METAL
	008.09	STATOR /50	37	50	1x [60÷80]	840	600	330	52	METAL
	008.10	STATOR /60	44	60	1x [77÷93]	840	600	330	78	METAL
	008.111	STATOR /80	55÷59	75÷80	1x [77÷127]	840	600	330	78	METAL
	008.12	STATOR /90	66	90	1x [102÷155]	1040	800	330	114	METAL
	008.13	STATOR /100	75	100	1x [102÷170]	1040	800	330	120	METAL
	008.15	STATOR /150	110	150	1x [127÷212]	1400	800	430	140	METAL
	008.16	STATOR /180	132	180	1x [153÷255]	1400	800	430	150	METAL
	008.171	STATOR /250	184	250	1x [212÷357]	1600	1000	430	260	METAL
008.18	STATOR /300	220	300	1x [255÷425]	1800	1000	430	290	METAL	
008.191	STATOR /350	257	350	1x [306÷510]	1800	1000	430	300	METAL	

Su richiesta è possibile realizzare il quadro per funzionamento per 2 o 3 motori.

On request it is possible to realize the panel for 2 or 3 motors operation.

Sur demande, il est possible de réaliser le panneau pour le fonctionnement de 2 ou 3 moteurs.

Accessori a pag. 100

Accessories on pag. 100

Accessoires à la page 100

Optionals pag.107

# AUTOTRASF

Quadro elettromeccanico per avviamento con autotrasformatore di 1 motore trifase

Electromechanical panel for start-up with auto-transformer of 1 three phase motor

Coffret électromécanique pour le démarrage avec autotransformateur de 1 moteur triphasé

7,5 → 257 kW



## SERIE AUTOTRASF

- Sezionatore generale con bloccaporta
- Fusibili di protezione
- Trasformatore 230-400/24V per circuiti ausiliari
- 1 ingresso per comando di marcia
- 1 ingresso per comando di arresto minimo livello
- Selettore AUTO-0-MAN (manuale stabile)
- Spia LED blu presenza rete
- Spia LED verde motore in funzione
- Spia LED rossa allarme motore in protezione
- Autotrasformatore di avviamento
- Contattori di linea/autotrasformatore in AC3
- 4 manovre/ora di cui max. 2 consecutive
- Tempo di accelerazione 15 sec. max
- Relé termico di sovraccarico ripristinabile internamente
- Temporizzatore scambio impedenza 0÷30sec.
- Klixon protezione autotrasformatore

## AUTOTRASF SERIES

- Main switch with door interlock
- Protection fuses
- Transformer 230-400/24V for auxiliary circuits
- 1 input for start command
- 1 input for stop command for minimum level
- Selector AUTO-0-MAN (manual stable)
- Blue LED for power on
- Green LED for motor operating
- Red LED for motor protection alarm
- Autotransformer starter
- Line/auto-transformer contactors AC3
- 4 Start per hour of which not more than 2 consecutively
- Acceleration time max 15 sec.
- Overload thermal relay internally restorable
- Timer for impedance exchange 0÷30sec.
- Klixon of transformer protection

## SÉRIE AUTOTRASF

- Sectionneur général avec verrouillage de porte
- Fusibles de protection
- Transformateur 230-400/24V circuits auxiliaires
- 1 entrée pour command de démarrage
- 1 entrée pour la commande d'arrêt niveau min.
- Sélecteur AUTO-0-MAN (manuel stable)
- LED bleu de présence réseau
- LED vert de moteur en fonction
- LED rouge d'alarme moteur en protection
- Autotransformateur de démarrage
- Contacteurs de ligne/autotransformateur AC3
- 4 démarrages/h pas plus que 2 consécutives
- Temps d'accélération max 15 sec.
- Relais thermique de surcharge à rétablissement interne
- Horloge pour échange d'impédance 0÷30sec.
- Klixon de protection de transformateur

# AUTOTRASF

IP 55

+40°  
-5°  
°C

50%  
@ 40°C

## APPLICAZIONI TIPICHE / STANDARD APPLICATIONS / APPLICATIONS TYPIQUES

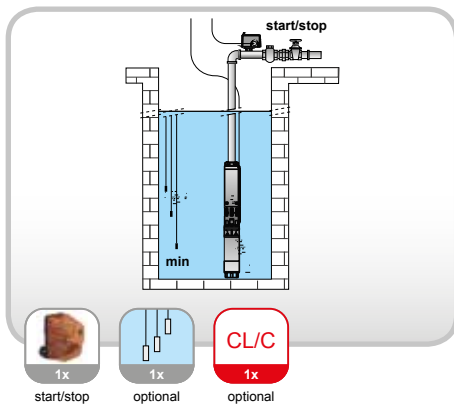
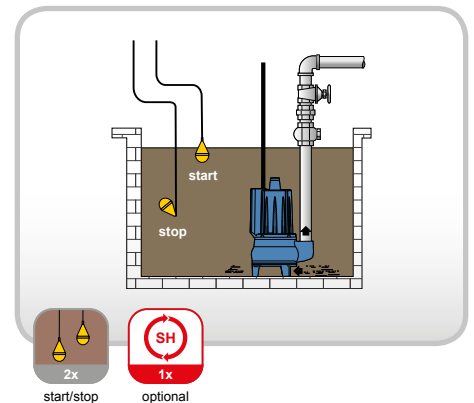
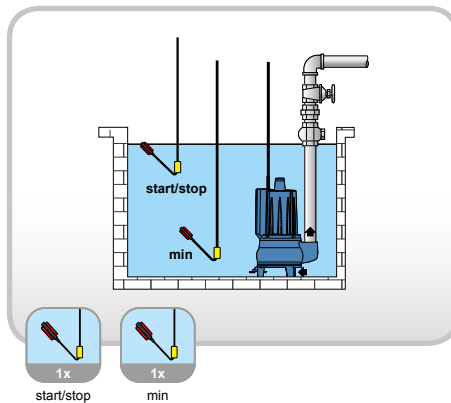
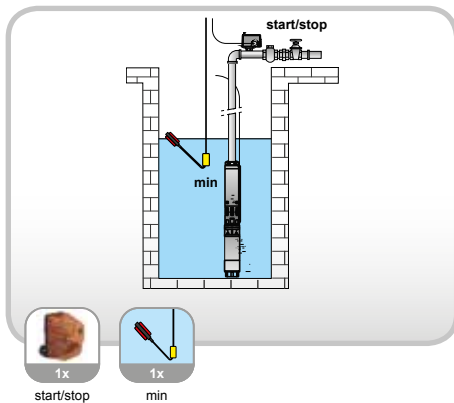

**Quadro elettrico per n.1 motore**  
Control panel for n.1 motor  
Coffret électronique pour n.1 moteur

V	COD.	MODELLO / MODEL	POTENZA / POWER		CORRENTE / CURRENT	L x W x H			kg	box
			kW	Hp		H mm	L mm	W mm		
50/60 Hz					Nx [range] A					
3~400V	007.51	<b>AUTOTRASF /10</b>	7,5	10	1x [14÷19]	530	400	230	21	METAL
	007.52	<b>AUTOTRASF /12,5</b>	9,2	12,5	1x [17÷21]	530	400	230	22	METAL
	007.53	<b>AUTOTRASF /15</b>	11	15	1x [20÷27]	530	400	230	22	METAL
	007.54	<b>AUTOTRASF /20</b>	15	20	1x [27÷32]	630	400	230	36	METAL
	007.55	<b>AUTOTRASF /25</b>	18,5	25	1x [30÷42]	630	400	230	36	METAL
	007.561	<b>AUTOTRASF /35</b>	22÷25,7	30÷35	1x [39÷55]	730	500	280	41	METAL
	007.57	<b>AUTOTRASF /40</b>	30	40	1x [51÷69]	840	600	330	43	METAL
	007.58	<b>AUTOTRASF /50</b>	37	50	1x [60÷80]	840	600	330	52	METAL
	007.59	<b>AUTOTRASF /60</b>	44	60	1x [77÷93]	840	600	330	78	METAL
	007.67	<b>AUTOTRASF /80</b>	55÷59	75÷80	1x [77÷127]	840	600	330	78	METAL
	007.68	<b>AUTOTRASF /90</b>	66	90	1x [102÷155]	1040	800	330	114	METAL
	007.61	<b>AUTOTRASF /100</b>	75	100	1x [102÷170]	1040	800	330	120	METAL
	007.63	<b>AUTOTRASF /150</b>	110	150	1x [127÷212]	1400	800	430	140	METAL
	007.64	<b>AUTOTRASF /180</b>	132	180	1x [153÷255]	1400	800	430	150	METAL
	007.651	<b>AUTOTRASF /250</b>	184	250	1x [212÷357]	1600	1000	430	260	METAL
007.66	<b>AUTOTRASF /300</b>	220	300	1x [255÷425]	1800	1000	430	290	METAL	
007.671	<b>AUTOTRASF /350</b>	257	350	1x [306÷510]	1800	1000	430	300	METAL	

Su richiesta è possibile realizzare il quadro per funzionamento per 2 o 3 motori.

Accessori a pag. 100

On request it is possible to realize the panel for 2 or 3 motors operation.

Accessories on pag. 100

Sur demande, il est possible de réaliser le panneau pour le fonctionnement de 2 ou 3 moteurs.

Accessoires à la page 100

Optionals pag.107

# ECOSOFT

Quadro elettromeccanico per avviamento soft-start di motori trifase

Electromechanical panel for soft start of three phase motors

Coffret électromécanique pour le démarrage progressif de moteurs triphasés

4 → 18,5 kW



foto indicative / indicative photos / photos indicatives

## SERIE ECOSOFT

- Sezionatore generale con bloccaporta
- Fusibili di protezione
- Trasformatore 230-400/24V per circuiti ausiliari
- 1 ingresso per comando di marcia
- 1 ingresso per comando di arresto minimo livello
- 1 selettore AUTO-0-MAN (manuale stabile)
- Spia LED rete, marcia, allarme motore in protezione
- Soft-starter interno dotato delle seguenti funzioni: protezioni mancanza fase, minima e massima tensione, sequenza fasi
- 4 manovre/ora di cui max. 2 consecutive

## ECOSOFT SERIES

- Main switch with door interlock
- Protection fuses
- Transformer 230-400/24V for auxiliary circuits
- 1 input for start command
- 1 input for stop command for minimum level
- 1 selector AUTO-0-MAN (manual stable)
- LED for power on, operating, protection alarm
- Internal soft starter with the following features: lack of phases protection, min and max voltage, phase sequence
- 4 start/h of which not more than 2 consecutively

## SÉRIE ECOSOFT

- Sectionneur général avec verrouillage de porte
- Fusibles de protection
- Transformateur 230-400/24V circuits auxiliaires
- 1 entrée pour command de démarrage
- 1 entrée pour la commande d'arrêt niveau min.
- 1 sélecteur AUTO-0-MAN (manuel stable)
- LED présence réseau, moteur en fonct., protection
- Démarrage progressif avec les suivantes fonctions: protection en absence de phase, min et max tension, séquence des phases
- 4 Démarrages/h, pas plus que 2 consécutives



# ECOSOFT

IP 55

+40°  
-5°  
°C

50%  
@ 40°C

## APPLICAZIONI TIPICHE / STANDARD APPLICATIONS / APPLICATIONS TYPIQUES

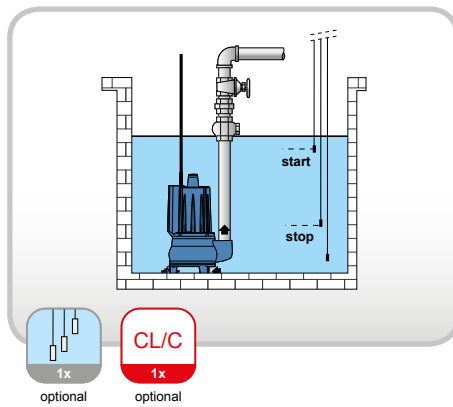
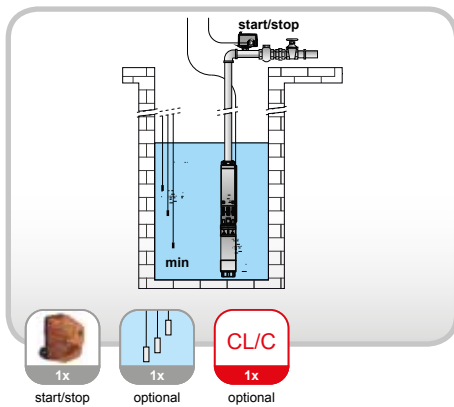
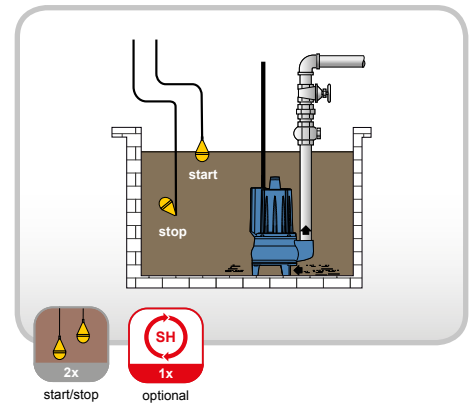
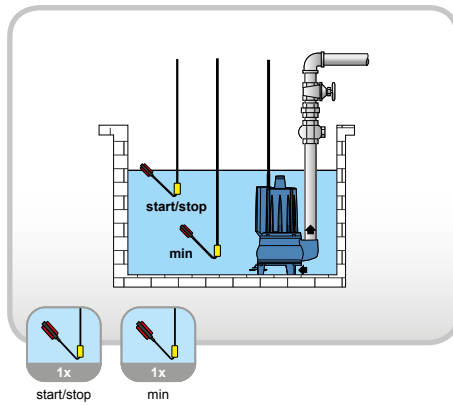
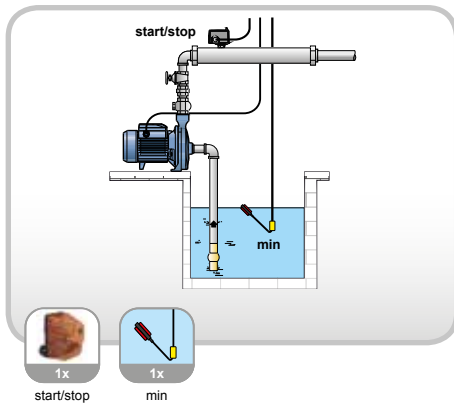

**1** Quadro elettrico per n.1 motore  
Control panel for n.1 motor  
Coffret électronique pour n.1 moteur

V	COD.	MODELLO / MODEL	POTENZA / POWER		CORRENTE / CURRENT	L x W x H			kg	box
			kW	Hp		H mm	L mm	W mm		
50/60 Hz					Nx [range] A					
3~400V	008.50	ECO-SOFT 1 /5,5	4	5,5	1x [7.6÷12]	430	300	230	9	METAL
	008.51	ECO-SOFT 1 /7,5	5,5	7,5	1x [11÷15]	430	300	230	9	METAL
	008.52	ECO-SOFT 1 /10	7,5	10	1x [14÷19]	430	300	230	9	METAL
	008.53	ECO-SOFT 1 /15	11	15	1x [20÷27]	430	300	230	9	METAL
	008.54	ECO-SOFT 1 /20	15	20	1x [27÷32]	430	300	230	10	METAL
	008.55	ECO-SOFT 1 /25	18,5	25	1x [30÷42]	430	300	230	10	METAL

# SOFT

Quadro elettromeccanico per avviamento soft-start di motori trifase

Electromechanical panel for soft start of three phase motors

Coffret électromécanique pour le démarrage progressif de moteurs triphasés

5,5 → 257 kW



## SERIE SOFT

- Sezionatore generale con bloccaporta
- Fusibili di protezione
- Trasformatore 230-400/24V per circuiti ausiliari
- 1 ingresso per comando di marcia
- 1 ingresso per comando di arresto minimo livello
- 1 selettore AUTO-0-MAN (manuale stabile)
- Kit ventilazione forzata
- Spia LED rete, marcia, allarme motore in protezione
- Soft-starter interno dotato delle seguenti funzioni:
  - display LCD (optional fronte quadro)
  - 4 lingue (italiano-inglese-francese-spagnolo)
  - menù di programm. base, esteso e funzioni
  - start-stop da tastiera
  - visualizz. tensione rete, corrente, potenza attiva e apparente per ogni fase, cos $\phi$ , Kwh
  - orologio datario con batteria tampone
  - rampe di accelerazione e decelerazione con controllo di coppia regolabili da tastiera
  - protezioni mancanza fase, minima e massima tensione, sequenza fasi
  - controllo remoto a PC con connessione RS232/RS485 e by-pass incorporato

### SOFT 2

- 2 ingressi per comando di marcia
- 2 ingressi per comando di arresto minimo livello
- 2 uscite motori soft starter

### SOFT 3

- 3 ingressi per comando di marcia
- 3 ingressi per comando di arresto minimo livello
- 3 uscite motori soft starter

## SOFT SERIES

- Main switch with door interlock
- Protection fuses
- Transformer 230-400/24V for auxiliary circuits
- 1 input for start command
- 1 input for stop command for minimum level
- 1 selector AUTO-0-MAN (manual stable)
- Forced ventilation kit
- LED for power on, operating, protection alarm
- Internal soft starter with the following features:
  - LCD (optional on front panel)
  - 4 languages (Italian-English-French-Spanish)
  - set-up menu base, extended and functions
  - start stop from keyboard
  - visualization main voltage, current, active and apparent power for each phase, cos $\phi$ , Kwh
  - clock datary with buffer battery
  - acceleration and deceleration ramps with torque control adjustable from keyboard
  - lack of phases protection, min and max voltage, phase sequence
  - remote control by pc connection RS232/RS485 and by-pass integrated

### SOFT 2

- 2 inputs for start command
- 2 inputs for stop command for minimum level
- 2 soft starter outputs

### SOFT 3

- 3 inputs for start command
- 3 inputs for stop command for minimum level
- 3 soft starter outputs

## SÉRIE SOFT

- Sectionneur général avec verrouillage de porte
- Fusibles de protection
- Transformateur 230-400/24V circuits auxiliaires
- 1 entrée pour command de démarrage
- 1 entrée pour la commande d'arrêt niveau min.
- 1 Sélecteur AUTO-0-MAN (manuel stable)
- Kit de ventilation forcée
- LED présence réseau; moteur en fonct., protection
- Démarrage progressif avec les suivantes fonctions:
  - écran (panneau avant optionnel)
  - 4 langues (italien, anglais, français, espagnol)
  - menu programmation base, étendu et fonctions
  - démarrage et arrêt dans clavier
  - affchage de la tension, courant, puissance active et apparent chaque phase, cos $\phi$ , Kwh
  - horloge calendrier avec batterie en tampon
  - rams d'accélération et ralentissement avec contrôle de couple réglable avec clavier
  - protection en absence de phase, min et max tension, séquence des phases
  - contrôle éloigné par connexion RS232 avec ordinateur et by-pass intégré

### SOFT 2

- 2 entrées pour command de démarrage
- 2 entrées pour la commande d'arrêt niveau min.
- 2 sorties moteurs soft starter

### SOFT 3

- 3 entrées pour command de démarrage
- 3 entrées pour la commande d'arrêt niveau min.
- 3 sorties moteurs soft starter

# SOFT 1

IP 55

+40°  
-5°  
°C

50%  
@ 40°C

## APPLICAZIONI TIPICHE / STANDARD APPLICATIONS / APPLICATIONS TYPIQUES

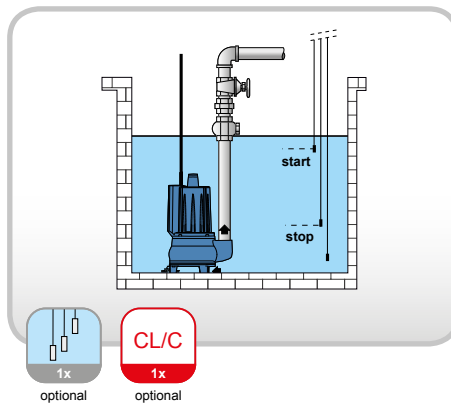
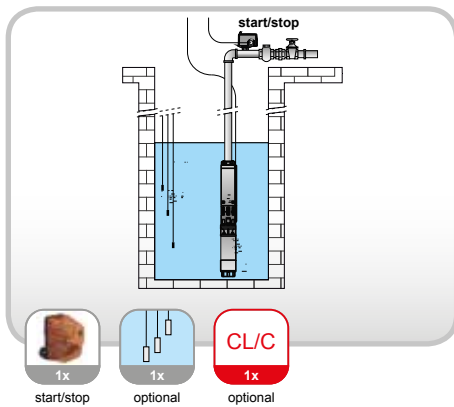
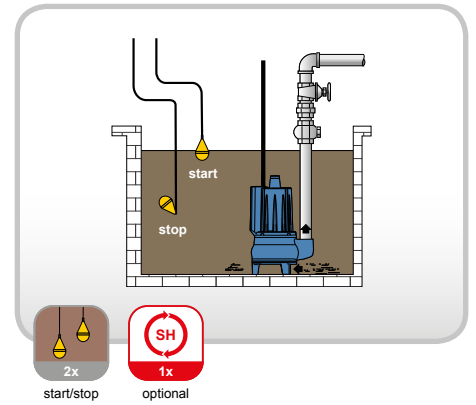
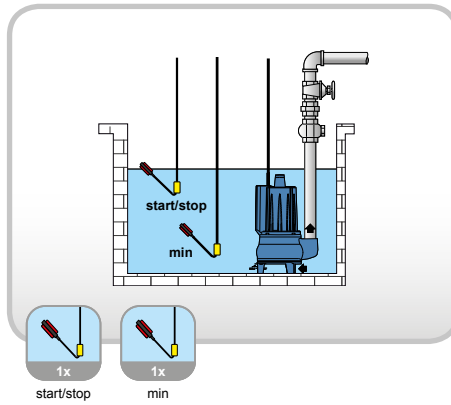
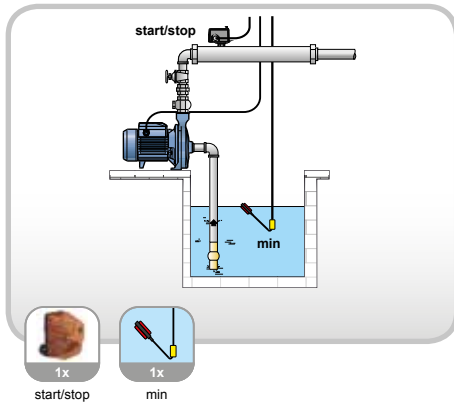

**Quadro elettrico per n.1 motore**  
Control panel for n.1 motor  
Coffret électronique pour n.1 moteur

V	COD.	MODELLO / MODEL	POTENZA / POWER		CORRENTE / CURRENT	L x W x H			kg	box
			kW	Hp		H mm	L mm	W mm		
50/60 Hz					Nx [range] A					
3~400V	009.02	SOFT 1 /7,5	5,5	7,5	1x [11÷15]	530	400	230	15	METAL
	009.04	SOFT 1 /15	11	15	1x [20÷27]	530	400	230	15	METAL
	009.06	SOFT 1 /25	18,5	25	1x [30÷42]	530	400	230	15	METAL
	009.07	SOFT 1 /30	22	30	1x [39÷55]	530	400	230	15	METAL
	009.08	SOFT 1 /40	30	40	1x [51÷69]	630	400	230	20	METAL
	009.09	SOFT 1 /50	37	50	1x [60÷80]	630	400	230	20	METAL
	009.10	SOFT 1 /60	44	60	1x [77÷93]	630	400	230	25	METAL
	009.12	SOFT 1 /80	55÷59	75÷80	1x [77÷127]	730	500	280	30	METAL
	009.13	SOFT 1 /100	75	100	1x [102÷156]	730	500	280	35	METAL
	009.14	SOFT 1 /125	92	125	1x [102÷182]	830	600	330	50	METAL
	009.15	SOFT 1 /150	110	150	1x [127÷212]	830	600	330	55	METAL
	009.16	SOFT 1 /180	132	180	1x [153÷255]	830	600	330	60	METAL
	010.58	SOFT 1 /250	184	250	1x [212÷357]	1900	1000	500	150	METAL
010.59	SOFT 1 /350	257	350	1x [306÷510]	1900	1000	500	180	METAL	
OPTIONAL	111.091	TR/ADX	Kit display esterno		External display kit	Kit écran extérieur				

# SOFT 2



## APPLICAZIONI TIPICHE / STANDARD APPLICATIONS / APPLICATIONS TYPIQUES

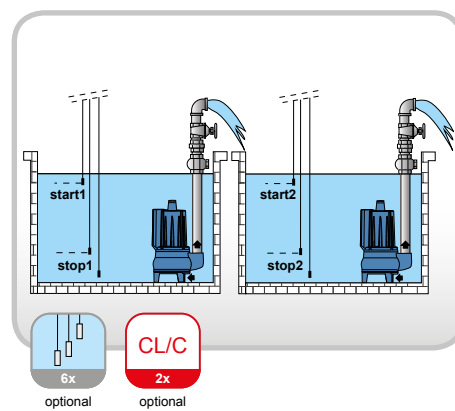
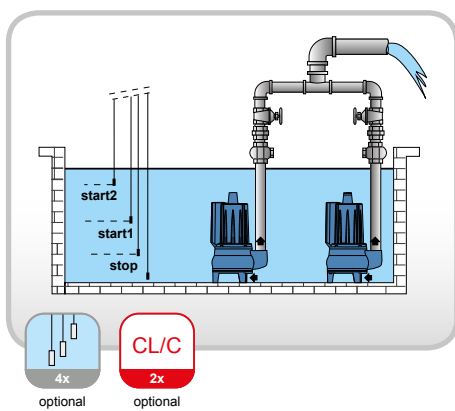
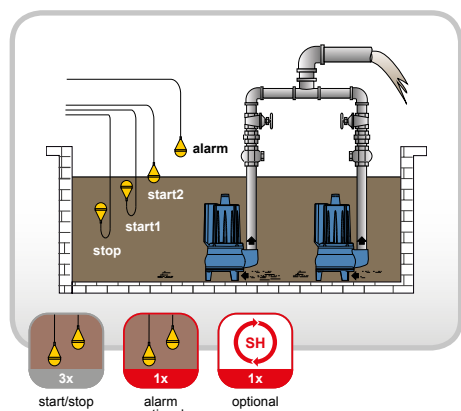
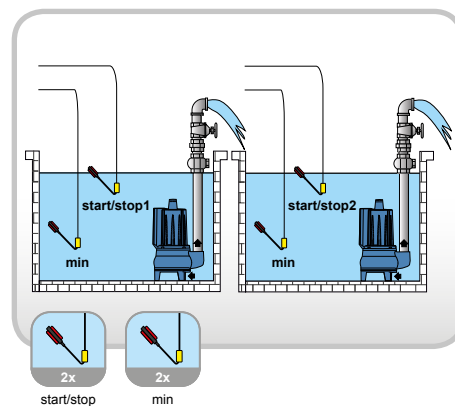
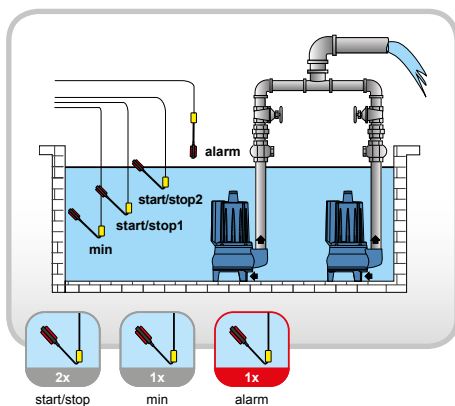
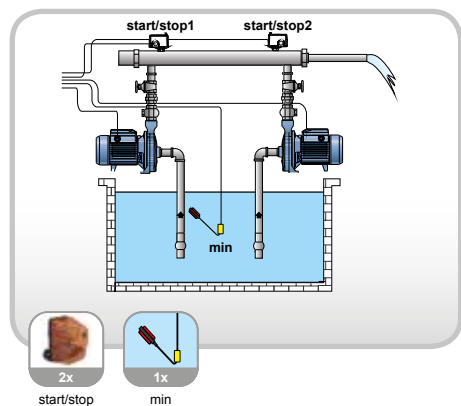

**Quadro elettrico per n.2 motori**  
Control panel for n.2 motors  
Coffret électronique pour n.2 moteurs

V	COD.	MODELLO / MODEL	POTENZA / POWER		CORRENTE / CURRENT	L x W x H			kg	box
			kW	Hp		H mm	L mm	W mm		
3~400V	008.79	SOFT 2 /7,5	5,5	7,5	2x [11÷15]	630	400	230	20	METAL
	008.81	SOFT 2 /15	11	15	2x [20÷27]	630	400	230	20	METAL
	008.83	SOFT 2 /25	18,5	25	2x [30÷42]	630	400	230	20	METAL
	008.84	SOFT 2 /30	22	30	2x [39÷55]	630	400	230	20	METAL
	008.85	SOFT 2 /40	30	40	2x [51÷69]	730	500	280	35	METAL
	008.86	SOFT 2 /50	37	50	2x [60÷80]	730	500	280	35	METAL
	008.87	SOFT 2 /60	44	60	2x [77÷93]	730	500	280	35	METAL
	008.89	SOFT 2 /80	55÷59	75÷80	2x [77÷127]	830	600	330	45	METAL
	008.90	SOFT 2 /100	75	100	2x [102÷156]	830	600	330	45	METAL
	008.91	SOFT 2 /125	92	125	2x [102÷182]	1030	800	300	60	METAL
	008.92	SOFT 2 /150	110	150	2x [127÷212]	1030	800	300	70	METAL
	008.93	SOFT 2 /180	132	180	2x [153÷255]	1030	800	300	80	METAL
	010.60	SOFT 2 /250	184	250	2x [212÷357]	1900	2000	500	300	METAL
	010.61	SOFT 2 /350	257	350	2x [306÷510]	1900	2000	500	360	METAL
OPTIONAL	111.091	TR/ADX	Kit display esterno (ordinare 2 pz.)		External display kit (order 2 pcs.)	Kit écran extérieur (commander 2 pcs.)				

- 2 ingressi per comando di marcia
- 2 ingressi per comando di arresto minimo livello
- 2 uscite motori soft starter

- 2 inputs for start command
- 2 inputs for stop command for minimum level
- 2 soft starter outputs

- 2 entrées pour command de démarrage
- 2 entrées pour la commande d'arrêt niveau min.
- 2 sorties moteurs soft starter

# SOFT 3

IP 55

+40°  
-5°  
°C

50%  
@ 40°C

## APPLICAZIONI TIPICHE / STANDARD APPLICATIONS / APPLICATIONS TYPIQUES

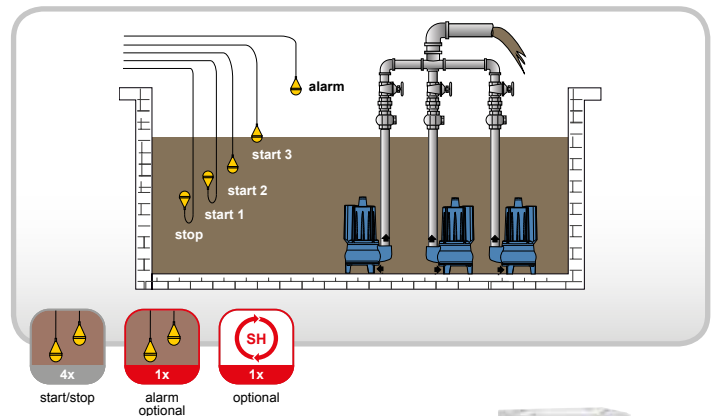
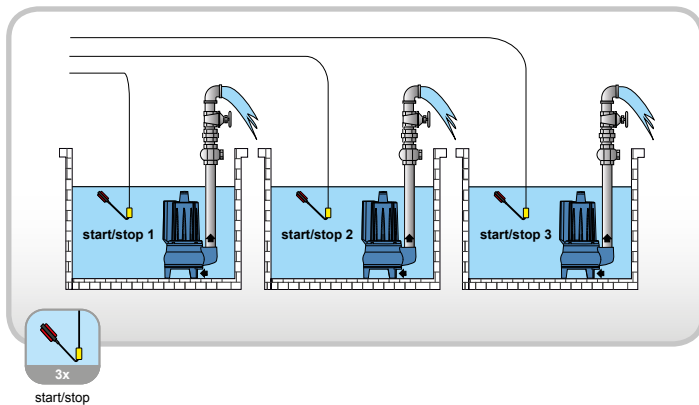
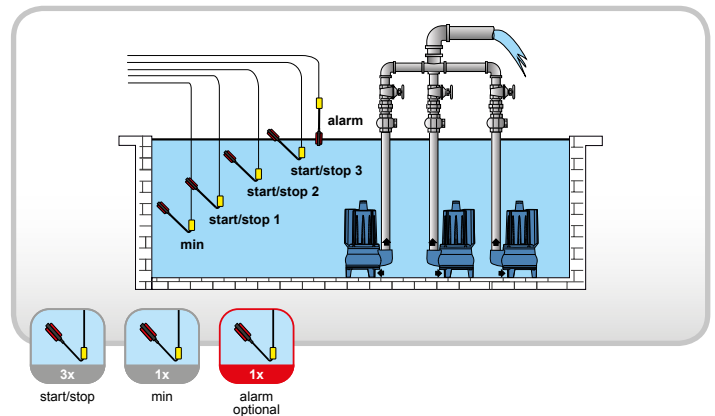
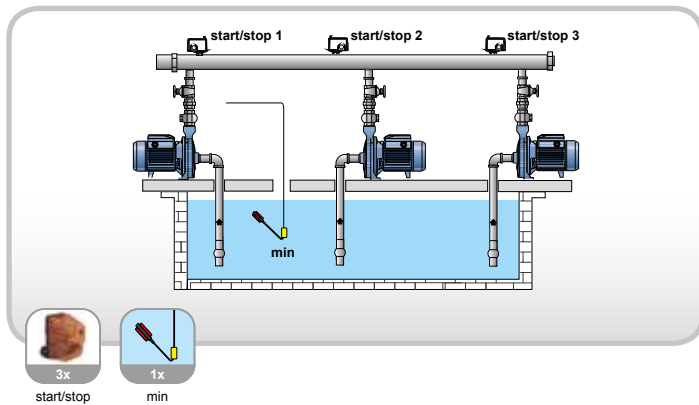

**Quadro elettrico per n.3 motori**  
Control panel for n.3 motors  
Coffret électronique pour n.3 moteurs

V	COD.	MODELLO / MODEL	POTENZA / POWER		CORRENTE / CURRENT	L x W x H			kg	box	
			kW	Hp		H mm	L mm	W mm			
50/60 Hz	009.701	<b>SOFT 3 /7,5</b>	5,5	7,5	3x [11÷15]	730	500	280	30	METAL	
	009.71	<b>SOFT 3 /15</b>	11	15	3x [20÷27]	730	500	280	30	METAL	
	009.73	<b>SOFT 3 /25</b>	18,5	25	3x [30÷42]	730	500	280	30	METAL	
	009.74	<b>SOFT 3 /30</b>	22	30	3x [39÷55]	730	500	280	30	METAL	
	009.75	<b>SOFT 3 /40</b>	30	40	3x [51÷69]	830	600	330	50	METAL	
	009.76	<b>SOFT 3 /50</b>	37	50	3x [60÷80]	830	600	330	50	METAL	
	009.77	<b>SOFT 3 /60</b>	44	60	3x [77÷93]	830	600	330	60	METAL	
	009.781	<b>SOFT 3 /80</b>	55÷59	75÷80	3x [77÷127]	1030	800	300	90	METAL	
	009.79	<b>SOFT 3 /100</b>	75	100	3x [102÷156]	1030	800	300	100	METAL	
	009.85	<b>SOFT 3 /125</b>	92	125	3x [102÷182]	1400	800	430	140	METAL	
	009.86	<b>SOFT 3 /150</b>	110	150	3x [127÷212]	1400	800	430	140	METAL	
	009.87	<b>SOFT 3 /180</b>	132	180	3x [153÷255]	1400	800	430	150	METAL	
	010.62	<b>SOFT 3 /250</b>	184	250	3x [212÷357]	1900	2000	500	450	METAL	
	010.63	<b>SOFT 3 /350</b>	257	350	3x [306÷510]	1900	2000	500	540	METAL	
<b>OPTIONAL</b>	111.091	<b>TR/ADX</b>	Kit display esterno (ordinare 3 pz.)			External display kit (order 3 pcs.)			Kit écran extérieur (commander 3 pcs.)		

- 3 ingressi per comando di marcia
- 3 ingressi per comando di arresto minimo livello
- 3 uscite motori soft starter

- 3 inputs for start command
- 3 inputs for stop command for minimum level
- 3 soft starter outputs

- 3 entrées pour command de démarrage
- 3 entrées pour la commande d'arrêt niveau min.
- 3 sorties moteurs soft starter

# ECO EASY

**Quadro elettromeccanico per avviamento con inverter di frequenza di 1 motore trifase**

Electromechanical panel for start-up with frequency inverter of 1 three phase motor

Coffret électromécanique pour le démarrage avec convertisseur de fréquence de 1 moteur triphasé

**0,37 → 4,0 kW**



## SERIE ECO EASY

- Fusibili di protezione
- 1 ingresso per comando di arresto minimo livello
- 1 ingresso per comando di marcia con selettore di funzionamento in manuale
- 1 ingresso analogico 4÷20mA (0-10V su richiesta)
- Selettore AUTO-0-MAN (manuale stabile)
- Inverter di Frequenza dotato delle seguenti funzioni:
  - display LCD alfanumerico retroilluminato
  - menù di programmazione funzioni
  - visualizzazione tensione rete, correnti di fase, potenza attiva e apparente per ogni fase,  $\cos\phi$  di ogni fase, Kwh
  - lista cronosequenziale degli eventi
  - rampe di accelerazione e decelerazione con controllo di coppia regolabili da tastiera
  - regolazione del "pid" per modificare la risposta di velocità e regolazione del sistema in funzione dell'impianto desiderato
  - controllo remoto mediante PC con connessione via convertitore RS232
  - protezioni mancanza fase, minima e massima tensione, sequenza, fasi

## ECO EASY SERIES

- Protection fuses
- 1 input for stop command for minimum level
- 1 input for start contact with selector for manual operation
- 1 analog input 4÷20mA (0-10V on demand)
- Selector AUTO-0-MAN (manual stable)
- Frequency inverter with the following functions:
  - LCD alphanumeric backlit
  - menu for functions set-up
  - display of main voltage, phase current, active and apparent power for each phase,  $\cos\phi$  of each phase, Kwh
  - chronological list of events
  - acceleration and deceleration ramps with torque control adjustable by keyboard
  - "pid" regulation for changing the speed response and regulation of the system
  - remote control by computer connection and program RS232
  - phase failure, min and max voltage, phase sequence protections

## SÉRIE ECO EASY

- Fusibles de protection
- 1 entrée pour la commande d'arrêt niveau min.
- 1 entrée pour command de démarrage avec sélecteur de fonctionnement en manuel
- 1 entrée analog. 4÷20 mA (0-10V sur demande)
- Sélecteur AUTO-0-MAN (manuel stable)
- Variateur de fréquence avec les suivantes fonctions:
  - écran alphanumérique rétro-éclairé
  - menu pour programmation de fonctions
  - visualisation de tension de réseau, courant de phase, puissance active et puissance apparente de chaque phase,  $\cos\phi$  de chaque phase, Kwh
  - liste de séquence chronologique des événements
  - rampes de accélération et de décélération avec contrôle de couple réglable via clavier
  - ajustement du "pid" pour changer la réponse de vitesse et ajustement du système en fonction d'usine souhaité
  - contrôle éloigné par connexion RS232 avec ordinateur
  - protection en absence de phase, min et max tension, séquence des phases

# ECO-EASY



## APPLICAZIONI TIPICHE / STANDARD APPLICATIONS / APPLICATIONS TYPIQUES

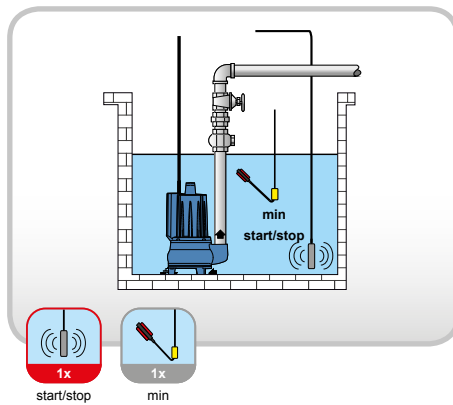
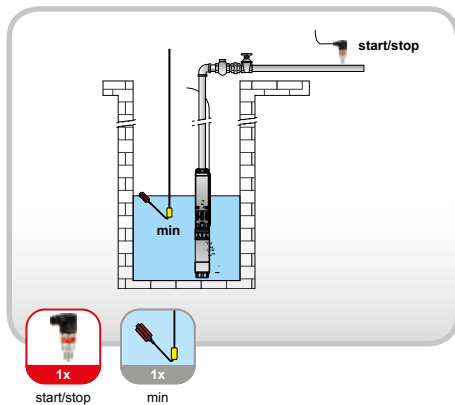
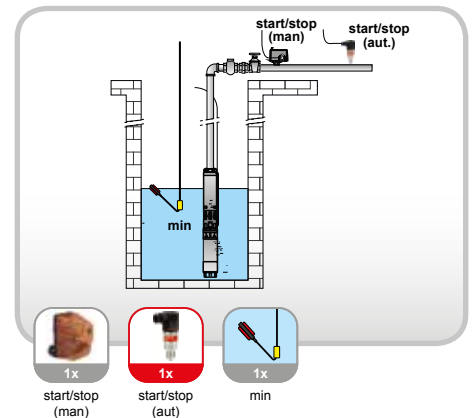
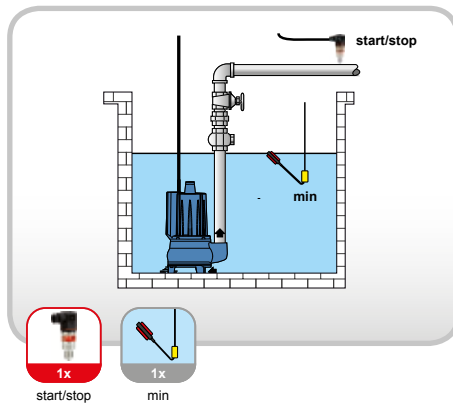
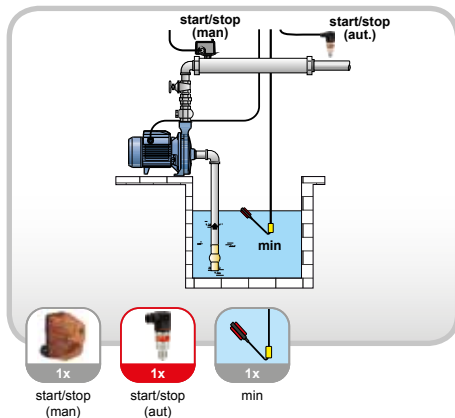

**Quadro elettrico per n.1 motore**  
Control panel for n.1 motor  
Coffret électronique pour n.1 moteur

V	COD.	MODELLO / MODEL	POTENZA / POWER		CORRENTE / CURRENT	L x W x H			kg	box
			kW	Hp		H mm	L mm	W mm		
50/60 Hz					Nx [range] A					
IN 1~230V OUT 3~230V	016.60	ECO-EASY /0,5 MT230	0,37	0,5	1x [0.7÷2.4]	340	240	170	3.5	ABS
	016.61	ECO-EASY /1 MT230	0,75	1	1x [1.4÷4.7]	340	240	170	3.5	ABS
	016.62	ECO-EASY /1,5 MT230	1,1	1,5	1x [2.3÷6.7]	340	240	170	3.5	ABS
	016.63	ECO-EASY /2 MT230	1,5	2	1x [2.3÷7.5]	340	240	170	4	ABS
	016.64	ECO-EASY /3 MT230	2,2	3	1x [3÷9.8]	340	240	170	4	ABS
IN 3~230V OUT 3~230V	016.65	ECO-EASY /0,5 TT230	0,37	0,5	1x [0.8÷2.6]	340	240	170	3.5	ABS
	016.66	ECO-EASY /0,75 TT230	0,55	0,75	1x [1.2÷3.9]	340	240	170	3.5	ABS
	016.67	ECO-EASY /1 TT230	0,75	1	1x [1.6÷5.2]	340	240	170	3.5	ABS
	016.68	ECO-EASY /1,5 TT230	1,1	1,5	1x [2.3÷7.4]	340	240	170	3.5	ABS
	016.69	ECO-EASY /2 TT230	1,5	2	1x [2.5÷8.3]	340	240	170	3.5	ABS
	016.70	ECO-EASY /3 TT230	2,2	3	1x [3.3÷10.8]	340	240	170	4	ABS
	016.71	ECO-EASY /4 TT230	3	4	1x [4.4÷14.6]	340	240	170	4	ABS
016.72	ECO-EASY /5 TT230	4	5,5	1x [5.8÷19.4]	340	240	170	4	ABS	
IN 3~400V OUT 3~400V	016.73	ECO-EASY /1 TT400	0,75	1	1x [0.8÷2.6]	340	240	170	3.5	ABS
	016.74	ECO-EASY /1,5 TT400	1,1	1,5	1x [1÷3.6]	340	240	170	3.5	ABS
	016.75	ECO-EASY /2 TT400	1,5	2	1x [1.5÷4.5]	340	240	170	3.5	ABS
	016.76	ECO-EASY /3 TT400	2,2	3	1x [2÷6.2]	340	240	170	3.5	ABS
	016.77	ECO-EASY /4 TT400	3	4	1x [2.5÷8]	340	240	170	3.5	ABS
016.78	ECO-EASY /5 TT400	4	5,5	1x [3÷9.7]	340	240	170	3.5	ABS	

# EASY INVERTER

Quadro elettromeccanico per avviamento con inverter di frequenza di motori trifase

Electromechanical panel for start-up with frequency inverter of 1 three-phase motor

Coffret électromécanique pour le démarrage avec convertisseur de fréquence de 1 moteur triphasé

1,1 → 200 kW



## SERIE EASY INVERTER

- Sezionatore generale con bloccaporta
- Fusibili di protezione
- Trasformatore 400+230/24V per circuiti ausiliari
- 1 ingresso per comando di arresto minimo livello
- 1 ingresso per comando di marcia con selettore di funzionamento in manuale
- 1 ingresso analogico 4÷20mA (0-10V su richiesta)
- 1 Selettore AUTO-O-MAN (manuale stabile)
- Kit ventilazione forzata
- Inverter di Frequenza dotato delle seguenti funzioni:
  - display LCD alfanumerico retroilluminato
  - menù di programmazione funzioni
  - visualizzazione tensione rete, corrente, potenza attiva e apparente per ogni fase, cosØ, Kwh
  - lista cronosequenziale degli eventi
  - orologio datario con batteria tampone
  - rampe di accelerazione e decelerazione con controllo di coppia regolabili da tastiera
  - regolazione del "pid" per modificare la risposta di velocità e regolazione del sistema in funzione dell'impianto desiderato
  - controllo remoto a PC con connessione RS232/RS485
  - protezioni mancanza fase, minima e massima tensione, sequenza fasi

### EASY INVERTER 2/EASY INVERTER 3

- INVERTER2: uscite 1 velocità variab.+1 velocità fissa
- INVERTER3: uscite 1 velocità variab.+2 velocità fissa

## EASY INVERTER SERIES

- Main switch with door interlock
- Protection fuses
- Transformer 400+230/24V for auxiliary circuits
- 1 input for stop command for minimum level
- 1 input for start command with selector in manual position
- 1 analog 4÷20 mA input (0-10V on demand)
- 1 selector for AUTO-O-MAN (manual stable)
- Forced ventilation kit
- Electronic frequency inverter with the following functions:
  - back-lighted LCD
  - set up menu: functions
  - visualization of main voltage, current, active and apparent power for each phase, cosØ, Kwh
  - chronosequential list of the events
  - clock datary with buffer battery
  - acceleration and deceleration ramps with torque control adjustable from keyboard
  - set up time of acceleration and deceleration "PID" (Proportional Integrated Derivated) set up
  - remote control by pc connection RS232/RS485
  - phase failure protection, min/max voltage protection, phase-sequence protection

### EASY INVERTER 2/EASY INVERTER 3

- INVERTER2: outputs 1 variable speed +1 fixed speed
- INVERTER3: outputs 1 variable speed +2 fixed speed

## SÉRIE EASY INVERTER

- Sectionneur général avec verrouillage de porte
- Fusibles de protection
- Transformateur 400+230/24V circuits auxiliaires
- 1 entrée pour la commande d'arrêt niveau min.
- 1 entrée pour command de démarrage avec sélecteur en position manuelle
- 1 entrée analog. 4÷20 mA (0-10V sur demande)
- 1 sélecteur AUTO-O-MAN (manuel stable)
- Kit de ventilation forcée
- Variateur de fréquence électronique avec les suivantes fonctions:
  - écran rétroéclairé
  - menu de programmation des fonctions
  - affchage de la tension, courant, puissance active et apparent pour chaque phase, cosØ, Kwh
  - liste séquence chronologique des événements
  - horloge calendrier avec batterie en tampon
  - rampes de accélération et de décélération avec contrôle de couple réglable via clavier
  - ajustement du "pid" pour changer la réponse de vitesse et ajustement du système en fonction d'usine souhaité
  - contrôle éloigné connexion RS232 avec ordinar.
  - protection en absence de phase, min et max tension, séquence des phases

### EASY INVERTER 2/EASY INVERTER 3

- INVERTER2: sorties 1 vitesse variab. +1 vitesse fixe
- INVERTER3: sorties 1 vitesse variab. +2 vitesse fixe



# EASY INVERTER 1

IP 54

+40°  
-5°  
°C

50%  
@ 40°C

## APPLICAZIONI TIPICHE / STANDARD APPLICATIONS / APPLICATIONS TYPIQUES

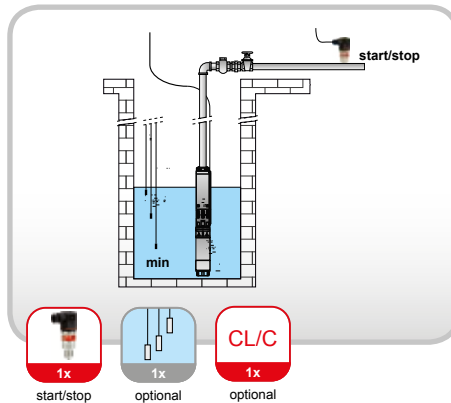
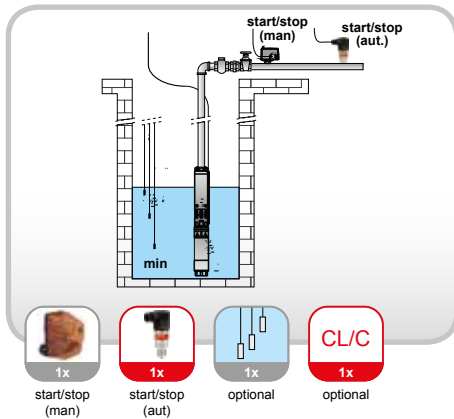
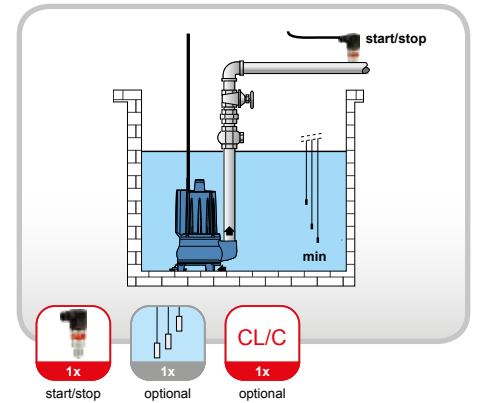
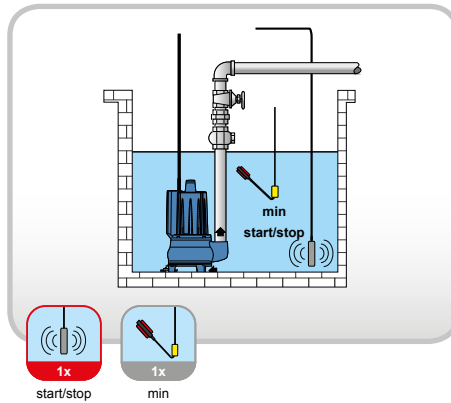
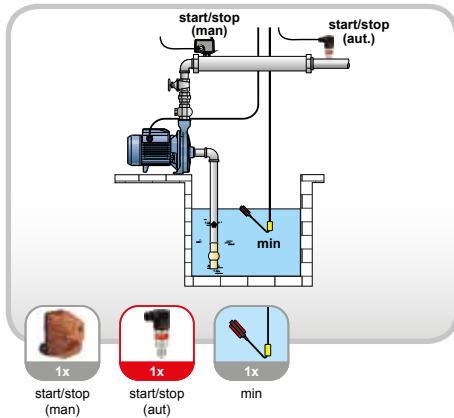

**Quadro elettrico per n.1 motore**  
Control panel for n.1 motor  
Coffret électronique pour n.1 moteur

V	COD.	MODELLO / MODEL	POTENZA / POWER		CORRENTE / CURRENT	L <sub>W</sub>			kg	box
			kW	Hp		H mm	L mm	W mm		
50/60 Hz					Nx [range] A					
3~400V	016.01	EASY INVERTERT 1/1.5	1,1	1,5	1x [1 ÷ 3,6]	530	400	230	16	METAL
	016.02	EASY INVERTERT 1/2	1,5	2	1x [1,5 ÷ 4,5]	530	400	230	16	METAL
	016.03	EASY INVERTERT 1/3	2,2	3	1x [2 ÷ 6,2]	530	400	230	16	METAL
	016.04	EASY INVERTERT 1/4	3	4	1x [2,5 ÷ 8]	530	400	230	16	METAL
	016.05	EASY INVERTERT 1/5.5	4	5,5	1x [3 ÷ 9,7]	530	400	230	16	METAL
	016.06	EASY INVERTERT 1/7.5	5,5	7,5	1x [4 ÷ 13,8]	530	400	230	18	METAL
	016.07	EASY INVERTERT 1/10	7,5	10	1x [5 ÷ 17,2]	530	400	230	18	METAL
	016.08	EASY INVERTERT 1/15	11	15	1x [7,5 ÷ 25,4]	530	400	230	20	METAL
	016.09	EASY INVERTERT 1/20	15	20	1x [10,5 ÷ 34,1]	730	500	280	25	METAL
	016.15	EASY INVERTERT 1/25	18,5	25	1x [12,5 ÷ 41,8]	730	500	280	25	METAL
	016.10	EASY INVERTERT 1/30	22	30	1x [14,5 ÷ 48,4]	730	500	280	30	METAL
	016.11	EASY INVERTERT 1/40	30	40	1x [11 ÷ 62]	1030	800	330	50	METAL
	016.12	EASY INVERTERT 1/50	37	50	1x [13 ÷ 73]	1030	800	330	50	METAL
	016.13	EASY INVERTERT 1/60	45	60	1x [15 ÷ 88]	1500	800	530	55	METAL
	016.14	EASY INVERTERT 1/75	55	75	1x [18 ÷ 106]	1500	800	530	80	METAL
	016.16	EASY INVERTERT 1/100	75	100	1x [25 ÷ 145]	1500	800	530	85	METAL
	016.17	EASY INVERTERT 1/125	90	125	1x [29 ÷ 169]	1500	800	530	90	METAL
016.18	EASY INVERTERT 1/150	110	150	1x [35 ÷ 206]	1500	800	530	100	METAL	
016.19	EASY INVERTERT 1/180	132	180	1x [41 ÷ 246]	2100	1000	630	150	METAL	
016.220	EASY INVERTERT 1/220	160	220	1x [49 ÷ 293]	2100	1000	630	180	METAL	
016.221	EASY INVERTERT 1/270	200	270	1x [61 ÷ 363]	2300	1200	630	200	METAL	

# EASY INVERTER 2

IP 54

+40°  
-5°  
°C

50%  
@ 40°C

## APPLICAZIONI TIPICHE / STANDARD APPLICATIONS / APPLICATIONS TYPIQUES

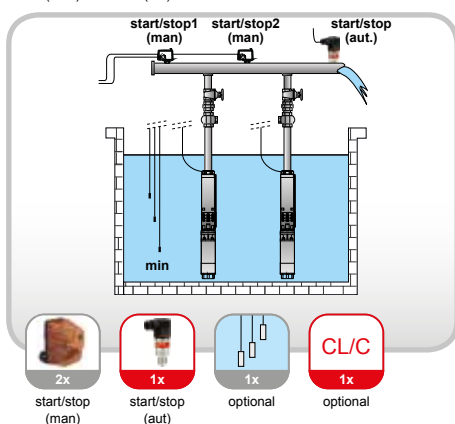
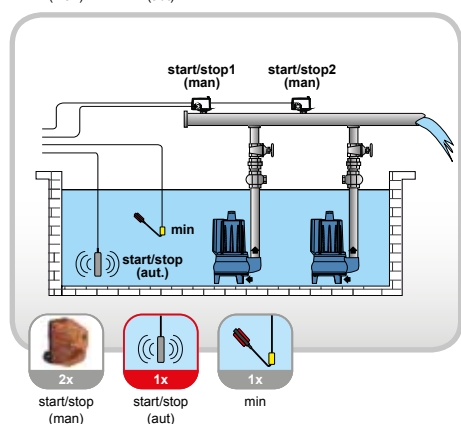
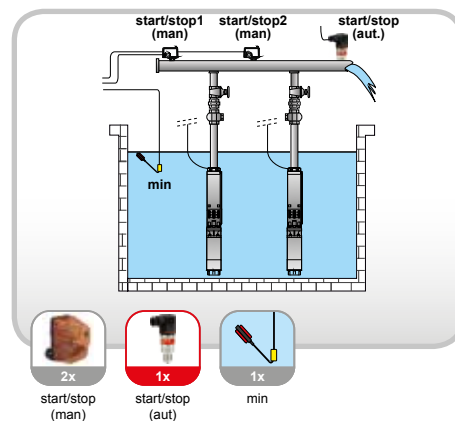
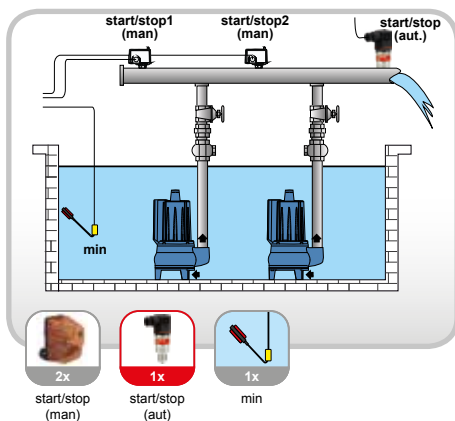
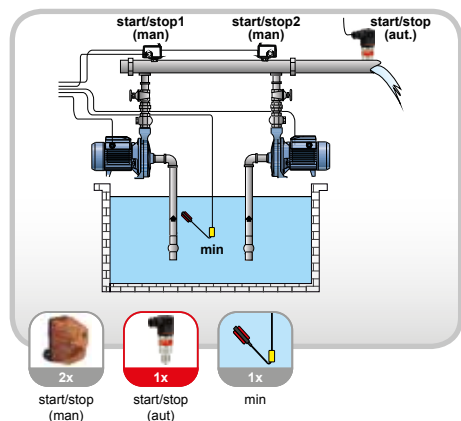

**Quadro elettrico per n.2 motori**  
Control panel for n.2 motors  
Coffret électronique pour n.2 moteurs

V	COD.	MODELLO / MODEL	POTENZA / POWER		CORRENTE / CURRENT	L			kg	box
			kW	Hp		H mm	L mm	W mm		
50/60 Hz	016.20	EASY INVERTER 2/1.5	1,1	1,5	2x [1÷3,6]	530	400	230	18	METAL
	016.21	EASY INVERTER 2/2	1,5	2	2x [1,5 ÷ 4,5]	530	400	230	18	METAL
	016.22	EASY INVERTER 2/3	2,2	3	2x [2÷6,2]	530	400	230	18	METAL
	016.23	EASY INVERTER 2/4	3	4	2x [2,5÷8]	530	400	230	18	METAL
	016.24	EASY INVERTER 2/5.5	4	5,5	2x [3÷9,7]	530	400	230	18	METAL
	016.25	EASY INVERTER 2/7.5	5,5	7,5	2x [4÷13,8]	530	400	230	18	METAL
	016.26	EASY INVERTER 2/10	7,5	10	2x [5÷17,2]	730	500	280	27	METAL
	016.27	EASY INVERTER 2/15	11	15	2x [7,5 ÷ 25,4]	730	500	280	27	METAL
	016.28	EASY INVERTER 2/20	15	20	2x [10,5 ÷ 34,1]	730	500	280	32	METAL
	016.34	EASY INVERTER 2/25	18,5	25	2x [12,5 ÷ 41,8]	830	600	330	28	METAL
	016.29	EASY INVERTER 2/30	22	30	2x [14,5 ÷ 48,4]	830	600	330	33	METAL
	016.30	EASY INVERTER 2/40	30	40	2x [11 ÷ 62]	1030	800	330	52	METAL
	016.31	EASY INVERTER 2/50	37	50	2x [13 ÷ 73]	1030	800	330	70	METAL
	016.32	EASY INVERTER 2/60	45	60	2x [15 ÷ 88]	1500	800	540	90	METAL
	016.33	EASY INVERTER 2/75	55	75	2x [18 ÷ 106]	1500	800	540	100	METAL
	016.35	EASY INVERTER 2/100	75	100	2x [25 ÷ 145]	1700	1000	540	110	METAL
	016.36	EASY INVERTER 2/125	90	125	2x [29 ÷ 169]	1700	1000	540	115	METAL
	016.37	EASY INVERTER 2/150	110	150	2x [35 ÷ 206]	1700	1000	540	120	METAL
	016.38	EASY INVERTER 2/180	132	180	2x [41 ÷ 246]	2100	1000	640	150	METAL
016.39	EASY INVERTER 2/220	160	220	2x [49 ÷ 293]	2100	1000	640	160	METAL	
016.79	EASY INVERTER 2/280	200	270	2x [61 ÷ 363]	2300	1400	640	200	METAL	

■ Uscite: 1 velocità variabile +1 velocità fissa

■ Outputs: 1 variable speed +1 fixed speed

■ Sorties: 1 vitesse variable +1 vitesse fixe

# EASY INVERTER 3

IP 54

+40°  
-5°  
°C

50%  
@ 40°C

## APPLICAZIONI TIPICHE / STANDARD APPLICATIONS / APPLICATIONS TYPIQUES

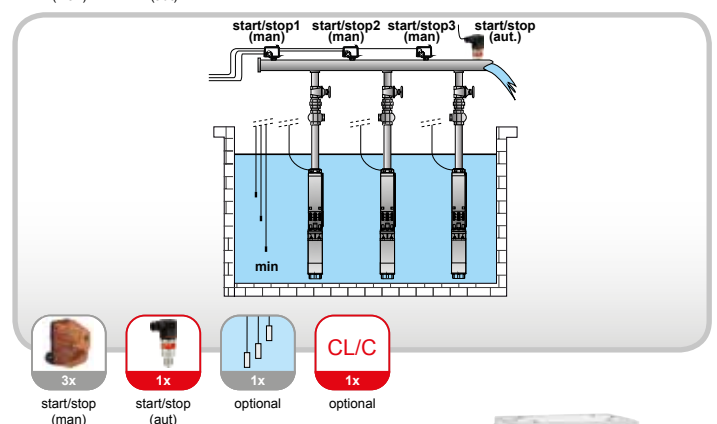
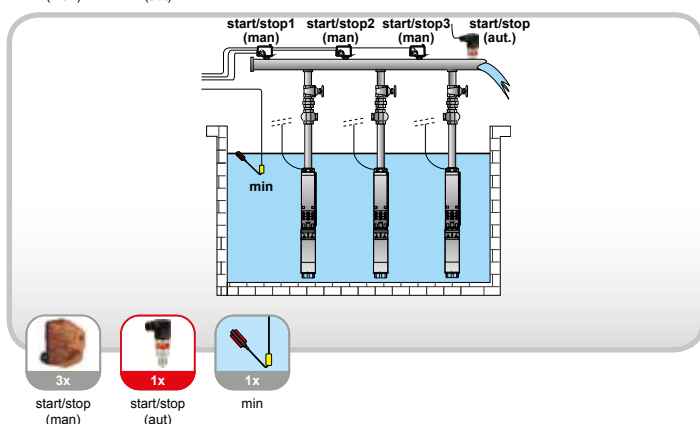
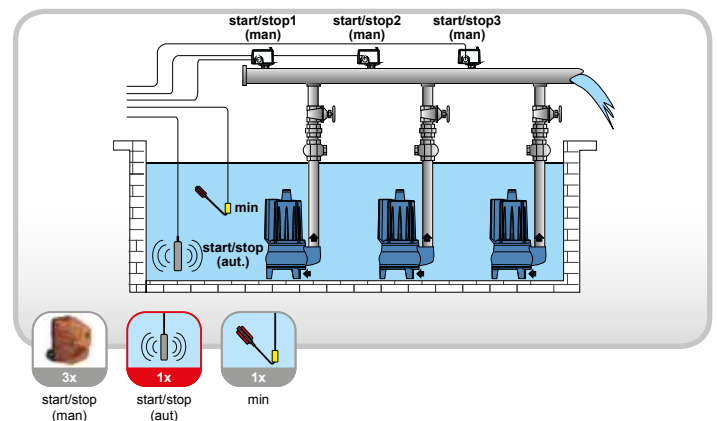
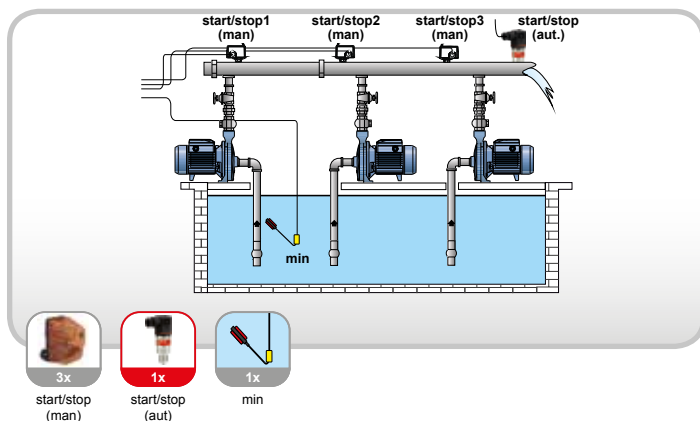

**Quadro elettrico per n.3 motori**  
Control panel for n.3 motors  
Coffret électronique pour n.3 moteurs

V	COD.	MODELLO / MODEL	POTENZA / POWER		CORRENTE / CURRENT	L x W x H			kg	box
			kW	Hp		H mm	L mm	W mm		
50/60 Hz					Nx [range] A					
3~400V	016.40	EASY INVERTER 3/1.5	1,1	1,5	3x [1÷3,6]	730	500	280	22	METAL
	016.41	EASY INVERTER 3/2	1,5	2	3x [1,5 ÷ 4,5]	730	500	280	22	METAL
	016.42	EASY INVERTER 3/3	2,2	3	3x [2÷6,2]	730	500	280	22	METAL
	016.43	EASY INVERTER 3/4	3	4	3x [2,5÷8]	730	500	280	22	METAL
	016.44	EASY INVERTER 3/5.5	4	5,5	3x [3÷9,7]	730	500	280	22	METAL
	016.45	EASY INVERTER 3/7.5	5,5	7,5	3x [4÷13,8]	730	500	280	22	METAL
	016.46	EASY INVERTER 3/10	7,5	10	3x [5÷17,2]	730	500	280	30	METAL
	016.47	EASY INVERTER 3/15	11	15	3x [7,5 ÷ 25,4]	730	500	280	30	METAL
	016.48	EASY INVERTER 3/20	15	20	3x [10,5 ÷ 34,1]	830	600	330	35	METAL
	016.54	EASY INVERTER 3/25	18,5	25	3x [12,5 ÷ 41,8]	830	600	330	35	METAL
	016.49	EASY INVERTER 3/30	22	30	3x [14,5 ÷ 48,4]	830	600	330	35	METAL
	016.50	EASY INVERTER 3/40	30	40	3x [11 ÷ 62]	1030	800	330	40	METAL
	016.51	EASY INVERTER 3/50	37	50	3x [13 ÷ 73]	1030	800	330	40	METAL
	016.52	EASY INVERTER 3/60	45	60	3x [15 ÷ 88]	1500	800	540	10	METAL
	016.53	EASY INVERTER 3/75	55	75	3x [18 ÷ 106]	1500	800	540	120	METAL
	016.55	EASY INVERTER 3/100	75	100	3x [25 ÷ 145]	1900	1200	540	130	METAL
	016.56	EASY INVERTER 3/125	90	125	3x [29 ÷ 169]	1900	1200	540	145	METAL
	016.57	EASY INVERTER 3/150	110	150	3x [35 ÷ 206]	1900	1200	540	150	METAL
016.58	EASY INVERTER 3/180	132	180	3x [41 ÷ 246]	2100	1400	640	190	METAL	
016.59	EASY INVERTER 3/220	160	220	3x [49 ÷ 293]	2100	1400	640	210	METAL	
016.80	EASY INVERTER 3/280	200	270	3x [61 ÷ 363]	2300	1400	640	250	METAL	

■ Uscite: 1 velocità variabile +2 velocità fissa

■ Outputs: 1 variable speed +2 fixed speed

■ Sorties: 1 vitesse variable +2 vitesse fixe

# EASY INVERTER D

Quadro elettromeccanico per avviamento con inverter di frequenza DANFOSS® FC202 di 1 motore trifase

Electromechanical panel for start-up with DANFOSS® FC202 frequency inverter of 1 three phase motor

Coffret électromécanique pour le démarrage avec convertisseur de fréquence DANFOSS® FC202 de 1 moteur triphasé

1,1 → 200 kW



## SERIE EASY INVERTER D

- Sezionatore generale con bloccaporta
- Fusibili di protezione
- Trasformatore 400+230/24V per circuiti ausiliari
- 1 ingresso per comando di arresto minimo livello
- 1 ingresso per comando di marcia con selettore di funzionamento in manuale
- 1 ingresso analogico 4÷20mA (0-10V su richiesta)
- 1 Selettore AUTO-O-MAN (manuale stabile)
- Kit ventilazione forzata
- Inverter di Frequenza DANFOSS® FC202 dotato delle seguenti funzioni:
  - display LCD alfanumerico retroilluminato
  - menù di programmazione funzioni
  - visualizzazione tensione rete, corrente, potenza attiva e apparente per ogni fase, cosØ, Kwh
  - lista cronosequenziale degli eventi
  - orologio datario con batteria tampone
  - rampe di accelerazione e decelerazione con controllo di coppia regolabili da tastiera
  - regolazione del "pid" per modificare la risposta di velocità e regolazione del sistema in funzione dell'impianto desiderato
  - controllo remoto a PC con connessione RS232/RS485
  - protezioni mancanza fase, minima e massima tensione, sequenza fasi

## EASY INVERTER D SERIES

- Main switch with door interlock
- Protection fuses
- Transformer 400+230/24V for auxiliary circuits
- 1 input for stop command for minimum level
- 1 input for start command with selector in manual position
- 1 analog 4÷20 mA input (0-10V on demand)
- 1 selector for AUTO-O-MAN (manual stable)
- Forced ventilation kit
- Electronic DANFOSS® FC202 frequency inverter with the following functions:
  - back-lighted LCD
  - set up menu: functions
  - visualization of main voltage, current, active and apparent power for each phase, cosØ, Kwh
  - chronosequential list of the events
  - clock datary with buffer battery
  - acceleration and deceleration ramps with torque control adjustable from keyboard
  - set up time of acceleration and deceleration
  - "PID" (Proportional Integrated Derivated) set up
  - remote control by pc connection RS232/RS485
  - phase failure protection, min/max voltage protection, phase-sequence protection

## SÉRIE EASY INVERTER D

- Sectionneur général avec verrouillage de porte
- Fusibles de protection
- Transformateur 400+230/24V circuits auxiliaires
- 1 entrée pour la commande d'arrêt niveau min.
- 1 entrée pour command de démarrage avec sélecteur en position manuelle
- 1 entrée analog. 4÷20 mA (0-10V sur demande)
- 1 sélecteur AUTO-O-MAN (manuel stable)
- Kit de ventilation forcée
- Variateur de fréquence électronique DANFOSS® FC202 avec les suivantes fonctions:
  - écran rétroéclairé
  - menu de programmation des fonctions
  - affchage de la tension, courant, puissance active et apparent pour chaque phase, cosØ, Kwh
  - liste séquence chronologique des événements
  - horloge calendrier avec batterie en tampon
  - rampes de accélération et de décélération avec contrôle de couple réglable via clavier
  - ajustement du "pid" pour changer la réponse de vitesse et ajustement du système en fonction d'usine souhaité
  - contrôle éloigné connexion RS232 avec ordinat.
  - protection en absence de phase, min et max tension, séquence des phases

# EASY INVERTER D

IP 54

+40°  
-5°  
°C

50%  
@ 40°C

## APPLICAZIONI TIPICHE / STANDARD APPLICATIONS / APPLICATIONS TYPIQUES

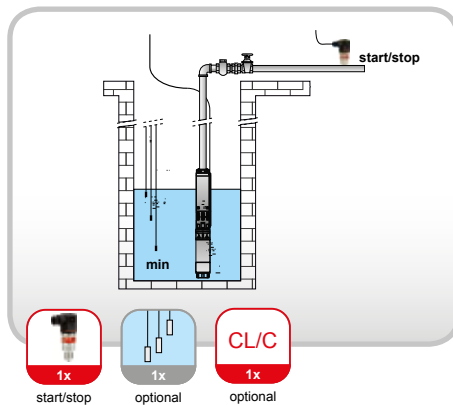
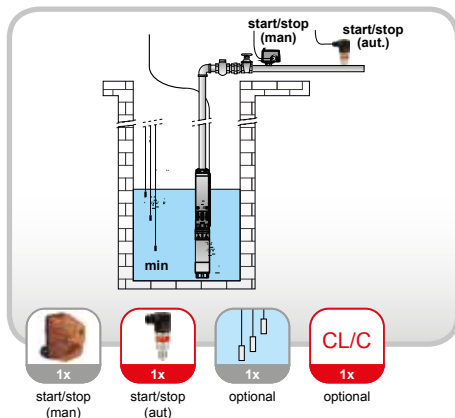
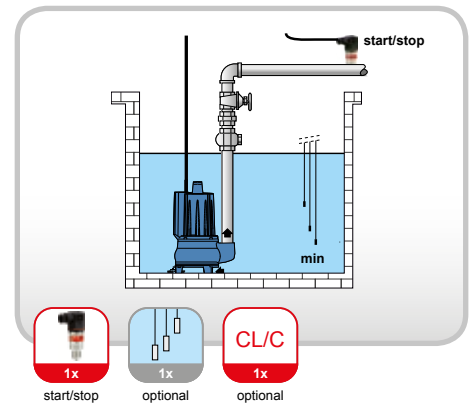
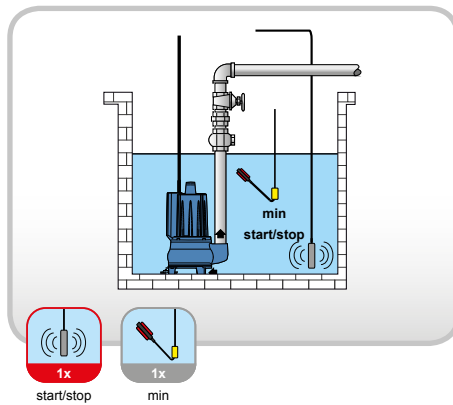
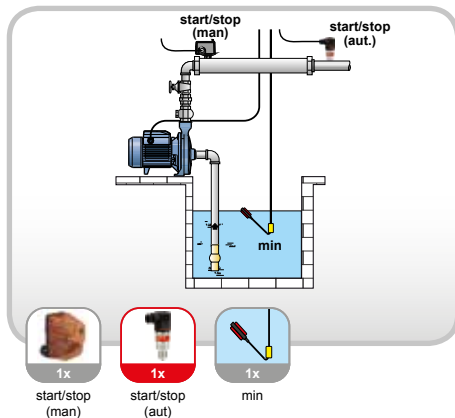

**Quadro elettrico per n.1 motore**  
Control panel for n.1 motor  
Coffret électronique pour n.1 moteur

V	COD.	MODELLO / MODEL	POTENZA / POWER		CORRENTE / CURRENT	L x W x H			kg	box
			kW	Hp		H mm	L mm	W mm		
3~400V	016.01D-FC202	EASY INVERTER D 1/1.5	1,1	1,5	1x max 3	730	500	280	16	METAL
	016.02D-FC202	EASY INVERTER D 1/2	1,5	2	1x max 4,1	730	500	280	16	METAL
	016.03D-FC202	EASY INVERTER D 1/3	2,2	3	1x max 5,6	730	500	280	16	METAL
	016.04D-FC202	EASY INVERTER D 1/4	3	4	1x max 7,2	730	500	280	16	METAL
	016.05D-FC202	EASY INVERTER D 1/5.5	4	5,5	1x max 10	730	500	280	16	METAL
	016.06D-FC202	EASY INVERTER D 1/7.5	5,5	7,5	1x max 13	730	500	280	18	METAL
	016.07D-FC202	EASY INVERTER D 1/10	7,5	10	1x max 16	730	500	280	18	METAL
	016.08D-FC202	EASY INVERTER D 1/15	11	15	1x max 24	730	500	280	20	METAL
	016.09D-FC202	EASY INVERTER D 1/20	15	20	1x max 32	730	500	280	25	METAL
	016.15D-FC202	EASY INVERTER D 1/25	18,5	25	1x max 37,5	830	600	330	25	METAL
	016.10D-FC202	EASY INVERTER D 1/30	22	30	1x max 44	830	600	330	30	METAL
	016.11D-FC202	EASY INVERTER D 1/40	30	40	1x max 61	1030	800	300	50	METAL
	016.12D-FC202	EASY INVERTER D 1/50	37	50	1x max 73	1230	800	300	50	METAL
	016.13D-FC202	EASY INVERTER D 1/60	45	60	1x max 90	1500	800	400	55	METAL
	016.14D-FC202	EASY INVERTER D 1/75	55	75	1x max 106	1500	800	400	80	METAL
	016.16D-FC202	EASY INVERTER D 1/100	75	100	1x max 147	1700	800	400	85	METAL
	016.17D-FC202	EASY INVERTER D 1/125	90	125	1x max 177	1700	800	400	90	METAL
	016.18D-FC202	EASY INVERTER D 1/150	110	150	1x max 212	1700	800	400	100	METAL
	016.19D-FC202	EASY INVERTER D 1/180	132	180	1x max 260	2100	800	400	150	METAL
	016.220D-FC202	EASY INVERTER D 1/220	160	220	1x max 315	2300	800	400	180	METAL
016.221D-FC202	EASY INVERTER D 1/270	200	270	1x max 395	2300	1600	400	200	METAL	

Su richiesta è possibile realizzare il quadro per funzionamento per 2 o 3 motori.

On request it is possible to realize the panel for 2 or 3 motors operation.

Sur demande, il est possible de réaliser le panneau pour le fonctionnement de 2 ou 3 moteurs.

Accessori a pag. 100

Accessories on pag. 100

Accessoires à la page 100

Optionals pag.107

# EASY INVERTER D M/F

Quadro elettromeccanico per avviamento motori trifase con inverter di frequenza DANFOSS® in configurazione Master/Follower  
 Electromechanical panel for starting three-phase motors with DANFOSS® frequency inverter in Master/Follower configuration  
 Coffret électromécanique pour le démarrage des moteurs triphasés avec variateur de fréquence DANFOSS® en configuration Master/Follower

1,1 → 200 kW



foto indicative / indicative photos / photos indicatives

## SERIE EASY INVERTER D M/F

- Sezionatore generale con bloccaporta
- Fusibili di protezione
- Trasformatore 400+230/24V per circuiti ausiliari
- 1 ingresso per comando di arresto minimo livello
- 1 ingresso per comando di marcia con selettore di funzionamento in manuale
- 1 ingresso analogico 4÷20mA (0-10V su richiesta)
- 1 selettore AUTO-0-MAN (manuale stabile)
- Kit ventilazione forzata
- Inverter di frequenza DANFOSS® FC202 per ogni pompa con le seguenti funzioni:
  - display LCD alfanumerico retroilluminato
  - menù di programmazione funzioni
  - visualizzazione tensione rete, corrente, potenza attiva e apparente per ogni fase, cos $\phi$ , Kwh
  - lista cronosequenziale eventi con datario
  - rampe di accelerazione e decelerazione con controllo di coppia regolabili da tastiera
  - regolazione del "pid" per modificare la risposta di velocità e regolazione del sistema in funzione dell'impianto desiderato
  - connessione RS232/RS485
  - protezioni mancanza fase, minima e massima tensione, sequenza fasi
- Funzionamento MASTER/FOLLOWER
- Continuità di funzionamento impianto in caso di guasto inverter (con doppio ingresso 4÷20mA)
- Massima stabilità impianto nei sistemi a pressione costante
- Minima usura pompe
- Rotazione priorità per bilanciamento n° ore funzionamento pompa

## EASY INVERTER D M/F SERIES

- Main switch with door interlock
- Protection fuses
- Transformer 400+230/24V for auxiliary circuits
- 1 input for stop command for minimum level
- 1 input for start command with selector in manual position
- 1 analog 4÷20 mA input (0-10V on demand)
- 1 selector for AUTO-0-MAN (manual stable)
- Forced ventilation kit
- DANFOSS® FC202 frequency inverter for each pump with the following functions:
  - back-lighted LCD
  - set up menu: functions
  - visualization of main voltage, current, active and apparent power for each phase, cos $\phi$ , Kwh
  - chronological sequence of events with date display
  - acceleration and deceleration ramps with keyboard-adjustable torque control
  - "pid" adjustment to change the speed response and system adjustment according to the desired system
  - RS232 / RS485 connection
  - phase failure, minimum and maximum voltage protections, phase sequence
- MASTER / FOLLOWER operation
- Continuity of system operation in case of inverter failure (with double 4÷20mA input)
- Maximum system stability in constant pressure systems
- Minimum pump wear
- Priority rotation for balancing of pump operating hours

## SÉRIE EASY INVERTER D M/F

- Sectionneur général avec verrouillage de porte
- Fusibles de protection
- Transformateur 400+230/24V circuits auxiliaires
- 1 entrée pour la commande d'arrêt niveau min.
- 1 entrée pour command de démarrage avec sélecteur en position manuelle
- 1 entrée analog. 4÷20 mA (0-10V sur demande)
- 1 sélecteur AUTO-0-MAN (manuel stable)
- Kit de ventilation forcée
- Convertisseur de fréquence DANFOSS® FC202 pour chaque pompe avec des fonctions suivantes:
  - écran rétroéclairé
  - menu de programmation des fonctions
  - affichage de la tension, courant, puissance active et apparent pour chaque phase, cos $\phi$ , Kwh
  - séquence chronologique des événements avec affichage de la date
  - rampes d'accélération et de décélération avec contrôle de couple réglable par clavier
  - réglage "pid" pour changer la réponse de la vitesse et le réglage du système en fonction du système souhaité
  - connexion RS232 / RS485
  - défaillance de phase, protections de tension minimum et maximum, séquence de phases
- Fonctionnement MAÎTRE/SUIVEUR
- Continuité de fonctionnement du système en cas de panne de l'onduleur (avec double entrée 4÷20mA)
- Stabilité maximale du système dans les systèmes à pression constante
- Usure minimale de la pompe
- Rotation prioritaire pour l'équilibrage des heures de fonctionnement de la pompe

# EASY INVERTER D M/F

IP 54

+40°  
-5°  
°C

50%  
@ 40°C

## APPLICAZIONI TIPICHE / STANDARD APPLICATIONS / APPLICATIONS TYPIQUES

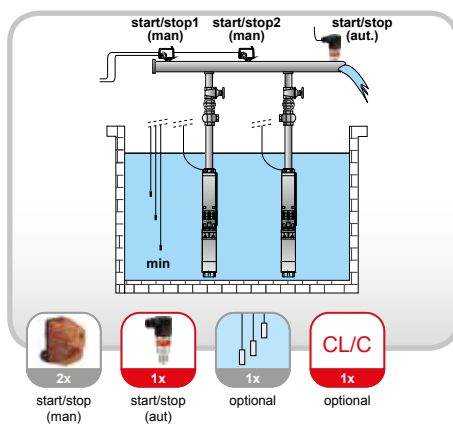
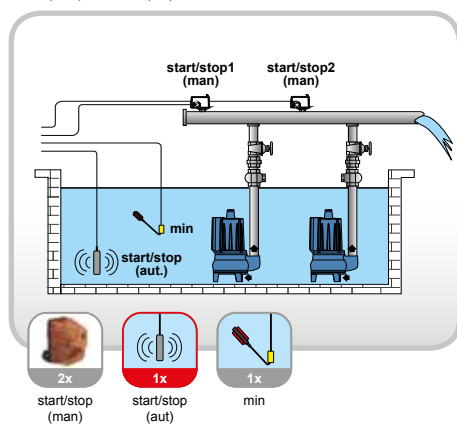
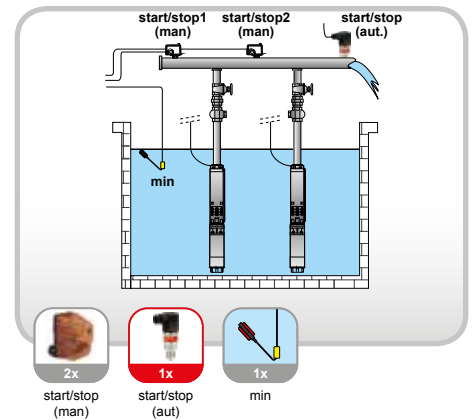
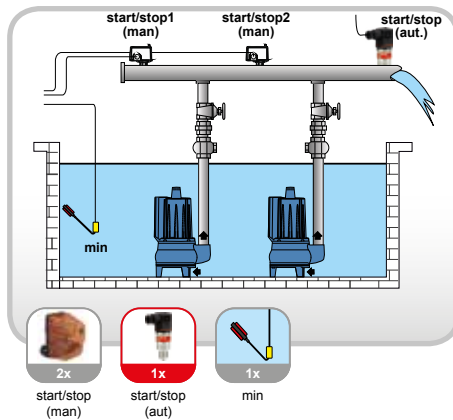
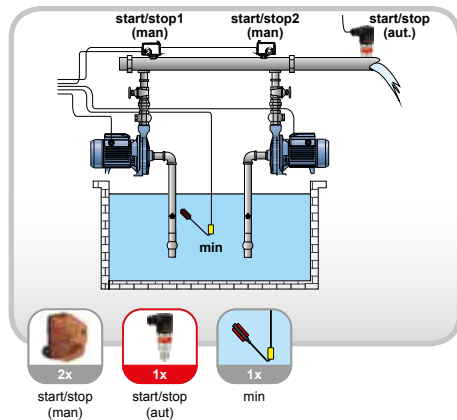

**Quadro elettrico per n.2 motori**  
Control panel for n.2 motors  
Coffret électronique pour n.2 moteurs

V	COD.	MODELLO / MODEL	POTENZA / POWER		CORRENTE / CURRENT	L			kg	box
			kW	Hp		H mm	L mm	W mm		
50/60 Hz					Nx max A					
3~400V	016.20D-2XFC202	EASY INVERTER D 2/1.5 2INV	1,1	1,5	2x max 3	730	500	250	80	METAL
	016.21D-2XFC202	EASY INVERTER D 2/2 2INV	1,5	2	2x max 4,1	730	500	250	80	METAL
	016.22D-2XFC202	EASY INVERTER D 2/3 2INV	2,2	3	2x max 5,6	730	500	250	80	METAL
	016.23D-2XFC202	EASY INVERTER D 2/4 2INV	3	4	2x max 7,2	730	500	250	85	METAL
	016.24D-2XFC202	EASY INVERTER D 2/5.5 2INV	4	5,5	2x max 10	730	500	250	85	METAL
	016.25D-2XFC202	EASY INVERTER D 2/7.5 2INV	5,5	7,5	2x max 13	830	600	300	90	METAL
	016.26D-2XFC202	EASY INVERTER D 2/10 2INV	7,5	10	2x max 16	1030	800	300	210	METAL
	016.27D-2XFC202	EASY INVERTER D 2/15 2INV	11	15	2x max 24	1030	800	300	210	METAL
	016.28D-2XFC202	EASY INVERTER D 2/20 2INV	15	20	2x max 32	1030	800	300	210	METAL
	016.34D-2XFC202	EASY INVERTER D 2/25 2INV	18,5	25	2x max 37,5	1500	800	600	250	METAL
	016.29D-2XFC202	EASY INVERTER D 2/30 2INV	22	30	2x max 44	1500	800	600	250	METAL
	016.30D-2XFC202	EASY INVERTER D 2/40 2INV	30	40	2x max 61	1500	800	600	250	METAL
	016.31D-2XFC202	EASY INVERTER D 2/50 2INV	37	50	2x max 73	1900	1000	500	280	METAL
	016.32D-2XFC202	EASY INVERTER D 2/60 2INV	45	60	2x max 90	1900	1000	500	280	METAL
	016.33D-2XFC202	EASY INVERTER D 2/75 2INV	55	75	2x max 106	2100	1200	600	460	METAL
	016.35D-2XFC202	EASY INVERTER D 2/100 2INV	75	100	2x max 147	2100	1200	600	460	METAL
	016.36D-2XFC202	EASY INVERTER D 2/125 2INV	90	125	2x max 177	2100	1200	600	480	METAL
	016.37D-2XFC202	EASY INVERTER D 2/150 2INV	110	150	2x max 212	2300	1200	600	620	METAL
016.38D-2XFC202	EASY INVERTER D 2/180 2INV	132	180	2x max 260	2300	1200	600	620	METAL	
016.39D-2XFC202	EASY INVERTER D 2/220 2INV	160	220	2x max 315	2300	1200	600	640	METAL	
016.79D-2XFC202	EASY INVERTER D 2/270 2INV	200	270	2x max 395	2300	1200	600	640	METAL	

Su richiesta è possibile realizzare il quadro per funzionamento per 3 motori.

On request it is possible to realize the panel for 3 motors operation.

Sur demande, il est possible de réaliser le panneau pour le fonctionnement de 3 moteurs.

Accessori a pag. 100

Accessories on pag. 100

Accessoires à la page 100

Optionals pag.107

# VFD-C

Inverter di frequenza COELBO® IP65 per controllo di 1 o 2 motori

COELBO® 1 or 2 motors driver IP65 managed by frequency inverter

Convertisseur de fréquence COELBO® IP65 pour le contrôle de 1 ou 2 moteurs

1,5 → 7,5 kW



foto indicative / indicative photos / photos indicatives

## SERIE VFD-C

- Inverter di frequenza COELBO®
- Completo di trasduttore da 10 bar
- Pannello di comando LCD con programmazione tasti START-STOP-AUTO
- Controllo di un motore mediante inverter di frequenza con controllo PID
- Possibilità di collegamento fino a 4 quadri in funzionamento MASTER-SLAVE
- Funzione periodica ripartenza in caso di momentanea mancanza d'acqua
- Riarmo automatico in mancanza alimentazione
- Ingresso livello minimo
- Protezione temperatura massima con autoregolazione e mantenimento motore in funzione
- Ingresso livello minimo
- Ingresso per sensori 4÷20mA
- Registro eventi (ore lavoro, n° avviamenti, connessioni rete elettrica)
- Registro allarmi (numero e tipo)
- Protezione per: tensione alimentazione anomala, cortocircuito fasi in uscita, anomalia sensore di pressione
- Gamma di prodotti in 2 versioni di contenitore: da parete o bordo motore

### VFD-2C

- Driver con 2 inverter con funzionamento in alternanza e cascata

## VFD-C SERIES

- COELBO® frequency inverter
- Complete with 10 bar transducer
- LCD control panel with START-STOP-AUTO keys programming
- Control of a motor by frequency inverter with PID control
- Possibility of connecting up to 4 panels in MASTER-SLAVE operation
- Periodic restart function in case of momentary lack of water
- Automatic reset in case of power failure
- input for minimum level
- Max temperature protection with self-regulation and user maintenance in operation
- 1 input for minimum level
- Input of sensor 4÷20mA
- Event log (working hours, number of starts, electricity connections)
- Alarm log (number and type)
- Protection for: abnormal power supply voltage, short circuit of output phases, pressure sensor anomaly
- Product range in 2 versions of box: wall or motor edge

### VFD-2C

- Driver with 2 inverters with alternation and cascade operation

## SÉRIE VFD-C

- Convertisseur de fréquence COELBO®
- Complet avec transducteur 10 bar
- Panneau de commande LCD avec programmation des touches START-STOP-AUTO
- Commande d'une moteur par variateur de fréquence avec contrôle PID
- Possibilité de connecter jusqu'à 4 panneaux en fonctionnement MASTER-SLAVE
- Fonction de redémarrage périodique en cas de manque d'eau momentané
- Réarmement automatique en cas de panne de courant
- Entrée de minimum niveau
- Protection maximale contre la température avec autorégulation et maintenance par l'utilisateur
- 1 Entrée pour command de minimum niveau
- Entrée capteur 4÷20mA
- Journal des événements (heures de travail, nombre de démarrages, connexions électriques)
- Journal d'alarme (numéro et type)
- Protection contre: tension d'alimentation anormale, court-circuit des phases de sortie, anomalie du capteur de pression
- Gamme de produits dans 2 versions de boîte: mur ou bord de moteur

### VFD-2C

- Driver avec 2 onduleurs avec alternance et fonctionnement en cascade



## VFD-C



## DA PARETE / FOR WALL / PUOR PAROI



**Inverter di frequenza per n.1 motore**  
Frequency inverter for n.1 motor  
Convertisseur de fréquence pour n.1 moteur

V	COD.	MODELLO / MODEL	POTENZA / POWER		CORRENTE / CURRENT	L-W-H			kg
			kW	Hp		H mm	L mm	W mm	
50/60 Hz					A Max				
IN 1~230V OUT 3~230V	002.95	VFD-C/4 MT230	3	4	10	344	186	173	4,5
IN 1~230V OUT 1~230V	002.97	VFD-C/2 MM230	1,5	2	12	344	186	173	3,5
IN 3~400V OUT 3~400V	002.99	VFD-C/5,5 TT400	4	5,5	9	344	186	173	4,5
	003.00	VFD-C/10 TT400	7,5	10	14	344	186	173	4,5



**Inverter di frequenza per n.2 motori**  
Frequency inverter for n.2 motors  
Convertisseur de fréquence pour n.2 moteurs

V	COD.	MODELLO / MODEL	POTENZA / POWER		CORRENTE / CURRENT	L-W-H			kg
			kW	Hp		H mm	L mm	W mm	
50/60 Hz					A Max				
IN 1~230V OUT 3~230V	003.08	VFD-2C-MM-MT230	3	4	10	344	186	173	4,8
IN 1~230V OUT 1~230V			1,5	2	12				
IN 3~400V OUT 3~400V	003.09	VFD-2C-TT400	4	5,5	9	344	186	173	4

## PER BORDO MOTORE / FOR MOTOR BOARD / POUR CÔTÉ MOTEUR



**Inverter di frequenza per n.1 motore**  
Frequency inverter for n.1 motor  
Convertisseur de fréquence pour n.1 moteur

V	COD.	MODELLO / MODEL	POTENZA / POWER		CORRENTE / CURRENT	L-W-H			kg
			kW	Hp		H mm	L mm	W mm	
50/60 Hz					A Max				
IN 1~230V OUT 3~230V	003.02	VFD-C/4-BP MT230	3	4	10	256	125	125	2,1
IN 1~230V OUT 1~230V	003.04	VFD-C/2-BP MM230	1,5	2	12	256	125	125	2,1
IN 3~400V OUT 3~400V	003.06	VFD-C/5,5-BP TT400	4	5,5	9	256	125	125	3,5
	003.07	VFD-C/10-BP TT400	7,5	10	14	256	125	125	3,5

# ALARM

**Avvisatore autoalimentato per segnalazione di allarme da contatti remoti**

Self-powered warning signal to indicate alarm via remote contacts

Avertisseur autoalimenté pour signal d'alarme depuis contacts distant



foto indicative / indicative photos / photos indicatives

## SERIE ALARM

- Fusibili di protezione
- Spia LED presenza rete
- Spie LED allarme, esclusione allarme
- Sirena allarme 90dB a 1 mt.
- Pulsante di esclusione/inclusione allarme sonoro
- Carica batterie
- Batteria tampone per alimentazione allarme 24h
- Selettore interno inserimento "Allarme continuo/Autoripristinabile"
- Selettore interno inserimento temporizzaz. sirena
- Regolatore temporizzazione allarme sonoro da 0"-180"
- 1 ingresso NA + 1 ingresso NC ALLARME
- 1 uscita contatti puliti (NC-C-NA)

### SLA1

- Lampeggiatore elettronico rosso

### SLA1+GSM

- Lampeggiatore elettronico rosso
- Kit modem GSM programmabile per l'invio a telefoni cellulari di segnale allarme (SMS) intervento sirena (il modem funziona con scheda ricaricabile GSM, SIM non inclusa)

## ALARM SERIES

- Protection fuses
- Power on indicator LED
- LED indicator: alarm shut-off, alarm indicator
- 90dB alarm siren at 1 metre
- Acoustic alarm enable/disable button
- Battery charger
- Back-up battery for 24h alarm power supply
- Internal selector to enable "Continuous/Selfresettable alarm"
- Internal selector to enable siren timing
- Acoustic alarm timer control settable from 0"-180"
- 1 NC input + 1 NO input ALARM
- 1 clean contact output (NO-COM-NC)

### SLA1

- Red electronic flashing light

### SLA1+GSM

- Red electronic flashing light
- Programmable GSM modem kit for delivery of siren activation alarm signal messages (SMS) to mobile phones (the model operates with a GSM pay as you go SIM card not included)

## SÉRIE ALARM

- Fusibles de protection
- Voyant LED de présence de tension
- Voyant LED: exclusion de l'alarme sonore, alarme
- Sirène 90dB à 1m
- Bouton d'exclusion/activation de l'alarme sonore
- Chargeur de batterie
- Batterie tampon pour alimentation de l'alarme 24h
- Sélecteur interne d'activation «Alarme continu/à réarmement automatique»
- Sélecteur interne d'activation temporisation sirène
- Régulateur de temporisation alarme sonore de 0"-180"
- 1 entrée NO + 1 entrée NC ALARM
- 1 sortie de contact propre (NO-COM-NC)

### SLA1

- Clignotant électronique rouge

### SLA1+GSM

- Clignotant électronique rouge
- Kit modem GSM programmable pour l'envoi sur des téléphones mobiles d'un signal d'alarme (SMS) d'intervention de la sirène (le modem fonctionne avec une carte rechargeable GSM, SIM non comprise)

## ALARM



## ALARM SA1



**Allarme acustico**  
Acoustic alarm  
Alarme acoustique

COD.	MODELLO / MODEL	ALIMENTAZIONE / VOLT	AUTONOMIA BATTERIE BATTERY ENDURANCE	PRESSIONE ACUSTICA ACOUSTIC PRESSURE	L W H			kg	box
		V	h	dB	H mm	L mm	W mm	kg	box
100.981	<b>SA1-230</b>	230Vac	24	90	340	240	170	1	ABS
100.982	<b>SA1-400</b>	400Vac	24	90	340	240	170	1	ABS

## ALARM SLA1



**Allarme acustico/luminoso**  
Acoustic/luminous alarm  
Alarme acoustique/lumineuse

COD.	MODELLO / MODEL	ALIMENTAZIONE / VOLT	AUTONOMIA BATTERIE BATTERY ENDURANCE	PRESSIONE ACUSTICA ACOUSTIC PRESSURE	L W H			kg	box
		V	h	dB	H mm	L mm	W mm	kg	box
100.991	<b>SLA1-230</b>	230Vac	24	90	410	240	170	1,5	ABS
100.992	<b>SLA1-400</b>	400Vac	24	90	410	240	170	1,5	ABS

## ALARM SLA1+GSM



**Allarme SMS e acustico/luminoso**  
SMS and acoustic/luminous alarm  
Alarme SMS et acoustique/lumineuse

COD.	MODELLO / MODEL	ALIMENTAZIONE / VOLT	AUTONOMIA BATTERIE BATTERY ENDURANCE	PRESSIONE ACUSTICA ACOUSTIC PRESSURE	L W H			kg	box
		V	h	dB	H mm	L mm	W mm	kg	box
100.993	<b>SLA1+GSM-230</b>	230Vac	24	90	410	240	170	1,8	ABS
100.994	<b>SLA1+GSM-400</b>	400Vac	24	90	410	240	170	1,8	ABS

# ALS

**Avisatore acustico/luminoso per la segnalazione di allarme da contatto remoto**

Acoustic/luminous warning signal to indicate alarm via remote contact

Avertisseur sonore/lumineux pour signal d'alarme depuis un contact distant



## SERIE ALS

- Fusibili di protezione
- Economico e compatto
- Alimentazione 12-24-230V (vedi modelli)
- Sirena allarme 90dB a 1 mt (modelli S1/LS1)
- Lampeggiatore elettronico rosso (modelli L1/LS1)
- Tasto per tacitazione sirena (modelli "+MUTE")

## ALS SERIES

- Protection fuses
- Economic and compact
- Power supply 12-24-230V (see models)
- 90dB alarm siren at 1 metre (S1/LS1 models)
- Red electronic flashing light (L1/LS1 models)
- Siren shut-off button ("MUTE" model only)

## SÉRIE ALS

- Fusibles de protection
- Économique et compact
- Alimentation 12-24-230V (voir modèles)
- Sirène 90dB à 1m (modèle S1/LS1)
- Clignotant électronique rouge (modèle L1/LS1)
- Touche d'arrêt de la sirène (modèle "+MUTE")

## ALS



## ALARM S1



**Allarme acustico**  
Acoustic alarm  
Alarme acoustique

COD.	MODELLO / MODEL	ALIMENTAZIONE / VOLT	L W H			kg	box
			H mm	L mm	W mm		
100.941	<b>S1-12</b>	12Vdc	160	160	140	0,5	ABS
100.951	<b>S1-24</b>	24Vac	160	160	140	0,5	ABS
100.961	<b>S1-220</b>	230Vac	160	160	140	0,5	ABS

## ALARM L1



**Allarme luminoso**  
Luminous alarm  
Alarme lumineuse

COD.	MODELLO / MODEL	ALIMENTAZIONE / VOLT	L W H			kg	box
			H mm	L mm	W mm		
100.942	<b>L1-12</b>	12Vdc	160	160	140	0,5	ABS
100.952	<b>L1-24</b>	24Vac	160	160	140	0,5	ABS
100.962	<b>L1-220</b>	230Vac	160	160	140	0,5	ABS

## ALARM LS1



**Allarme acustico/luminoso**  
Acoustic/luminous alarm  
Alarme acoustique/lumineuse

COD.	MODELLO / MODEL	ALIMENTAZIONE / VOLT	L W H			kg	box
			H mm	L mm	W mm		
100.94	<b>LS1-12</b>	12Vdc	160	160	140	0,5	ABS
100.95	<b>LS1-24</b>	24Vac	160	160	140	0,5	ABS
100.96	<b>LS1-220</b>	230Vac	160	160	140	0,5	ABS
100.94 M	<b>LS1-12 +MUTE</b>	12Vdc	160	160	140	0,5	ABS
100.95 M	<b>LS1-24 +MUTE</b>	24Vac	160	160	140	0,5	ABS
100.96 M	<b>LS1-220 +MUTE</b>	230Vac	160	160	140	0,5	ABS

# SIMPLEX-UP

Quadro elettronico per avviamento diretto di 1 pompa monofase o trifase

Electronic panel for direct start-up of 1 single or three phase pump

Coffret électronique pour démarrage direct de 1 pompe monophasée ou triphasée

0,37 → 15 kW



## SERIE SIMPLEX-UP

- Sezionatore generale con bloccaporta
- Fusibili di protezione
- Pulsanti AUTO-0-MAN (momentaneo)
- Spie LED rete, auto, marcia
- Spie LED allarme livello, sovraccarico motore
- Ingresso per 3 sonde unipolari
- Ingresso galleggiante/pressostato com. motore
- Ingresso galleggiante/pressostato Allarme
- Uscita motore: Relè(monofase)/Contattore(trifase)
- Regolatore sensibilità sonda
- Protezione motore da sovraccarico regolabile
- Tempo di intervento protezione 5"
- Uscita allarme ottico/acustico 12V 100mA
- Uscita allarme (contatti puliti NC-C-NA)
- Ingresso klixon motore con spia di intervento

## SIMPLEX-UP SERIES

- Main switch with door interlock
- Protection fuses
- AUTO-0-MAN buttons (manual temporary)
- LED power on, auto operation, motor operating
- LED level alarm, motor overload
- Input for 3 single-pole level probes
- Operating input multi-contact float/pressure switch
- Alarm input multi-contact float/pressure switch
- Output: Relay(single ph.)/Contactor(three ph.)
- Internal regulator for probes sensitivity
- Adjustable motor overload protection
- Time for activation of protection 5"
- Optical/acoustic alarm output
- Alarm output (volt free contact NO-COM-NC)
- Klixon input whit indicator light

## SÉRIE SIMPLEX-UP

- Sectionneur général avec verrouillage de porte
- Fusibles de protection
- Boutons-poussoirs AUTO-0-MAN (momentané)
- LED présence réseau, auto, moteur en fonction
- LED alarme niveau, surcharges moteur
- Entrée pour sondes de niveau unipolaire
- Entrée comande interrupteur à flotteur/pressostat
- Entrée allarme interrupteur à flotteur/pressostat
- Sortie moteur: Relais(monoph.)/Contacteur(triph.)
- Sélecteur intérieur pour sensibilité des sondes
- Protection électronique surcharge moteurs réglable
- Temps d'intervention protection 5"
- Sortie allarme sonore/lumineuse
- Sortie allarme (NO-COM-NC volts sans contact)
- Entrée klixon avec voyant lumineux



**Quadro elettrico per n.1 pompa**  
Control panel for n.1 pump  
Coffret électronique pour n.1 pompe



V	COD.	MODELLO / MODEL	POTENZA / POWER		CORRENTE / CURRENT	Dimensions			Weight	Box
			kW	Hp		H mm	L mm	W mm		
50/60 Hz					Nx [range] A					
3~400V	013.03	SIMPLEX-UP-T/10	0,55÷7,5	0,75÷10	1x [2÷15]	340	240	170	2,4	ABS
	013.04	SIMPLEX-UP-T/15	7,5÷11	10÷15	1x [16÷24]	340	240	170	2,6	ABS
	013.10	SIMPLEX-UP-T/20	7,5÷15	10÷20	1x [16÷32]	340	240	170	2,7	ABS

# EN-SLA 4/12

Allarme acustico/luminoso autoalimentato per segnalazione remota allarmi antincendio

Self-powered acoustic/luminous alarm to signal remote fire-fighting alarms

Alarme sonore/lumineuse autoalimentée pour signal d'alarme anti-incendie à distance



foto indicative / indicative photos / photos indicatives

## SERIE EN-SLA 4/12

- Quadro elettronico di segnalazione allarmi
- Trasformatore 230 V/24 V per circuiti ausiliari
- Ingressi NC per allarme "tipo A" (lamp. rosso)
- Ingressi NC per allarme "tipo B" (lamp. giallo)
- 1 ingresso NA per allarme "tipo B" (lamp. giallo)
- 3 spie "tensione", "allarme" e "sirena esclusa"
- 4 pulsanti "test", "reset", "attivazione sirena" e "esclusione sirena"
- Selettore interno (automatico-manuale)
- Selettore interno per attivazione timer spegnimento automatico sirena
- Trimmer ritardo spegnimento
- Cicalino di allarme sonoro 90dB 12Vcc
- Batteria sigillata interna (autonomia circa 24h)
- Lampade allarme lampeggiante rossa e gialla

## EN-SLA 4/12 SERIES

- Electronic control panel for alarm signalling
- Transformer 230 V/24 V for auxiliary circuit
- NC inputs for alarm "level A" (red flashing light)
- NC inputs for alarm "level A" (yellow flashing light)
- 1 NO input for alarm "level B" (yellow flashing light)
- 3 lights "power on", "alarm" and "beacon excluded"
- 4 pushbuttons "test", "reset", "beacon activation" and "beacon exclusion"
- Internal selector (automatic-manual)
- Internal selector for activation of the timer for automatic switch-off of the beacon
- Trimmer for switch-off time delay
- Alarm beacon 90dB 12Vcc
- Sealed internal battery (autonomy approx. 24h)
- Red and yellow alarm flashing lights

## SÉRIE EN-SLA 4/12

- Coffret de signalisation alarmes
- Transformateur 230/24V pour circuits auxiliaires
- Entrées NC pour allarme "niveau A" (rouge clign.)
- Entrées NC pour allarme "niveau A" (jaune clign.)
- 1 entrée NO pour allarme "niveau B" (jaune clign.)
- 3 lampes "réseau", "alarme" et "sirène désactivée"
- 3 Boutons "test", "reset", "activation sirène" and "exclusion sirène"
- Sélecteur interne (automatique-manuel)
- Sélecteur interne pour activation horloge d'extinction automatique
- Trimmer pour temps de retard extinction
- Sonnette d'alarme sonore 90dB 12Vcc
- Batterie scellée interne (autonomie environ 24h)
- Lampes clignotant rouge et jaune



**Allarme acustico/luminoso**  
Acoustic/luminous alarm  
Alarme acoustique/lumineuse



COD.	MODELLO / MODEL	N. INGRESSI TIPO A INPUT N. A TYPE	N. INGRESSI TIPO B INPUT N. B TYPE	PRESSIONE ACUSTICA ACOUSTIC PRESSURE	Dimensioni (mm)			Peso (kg)	Materiale
					H	L	W		
101.01	EN-SLA4/12	4	12	90	410	240	170	3	ABS

# EN-QAD 1

Quadro elettrico per il comando dell'elettropompa antincendio principale (avviamento diretto) EN12845

Electrical panel for control of main electric fire-fighting pump (direct start-up) EN12845

Coffret électrique pour la commande de l'électropompe anti-incendie principale (démarrage direct) EN12845

0,75 → 22 kW



foto indicative / indicative photos / photos indicatives



**Quadro elettrico per n.1 pompa**  
Control panel for n.1 pump  
Coffret électronique pour n.1 pompe

V	COD.	MODELLO / MODEL	POTENZA / POWER		CORRENTE / CURRENT	L x W x H			kg	box
			kW	Hp		H mm	L mm	W mm		
50/60 Hz					Nx [range] A					
3~400V	018.15	EN-QAD1/1,5	0,75÷1,1	1÷1,5	1x [2÷3,2]	540	400	230	15	METAL
	018.16	EN-QAD1/2	1,5	2	1x [3÷4,5]	540	400	230	15	METAL
	018.17	EN-QAD1/3	2,2	3	1x [4,5 ÷6,8]	540	400	230	15	METAL
	018.18	EN-QAD1/5,5	4	5,5	1x [3÷8]	540	400	230	15	METAL
	018.19	EN-QAD1/7,5	5,5	7,5	1x [9÷11]	540	400	230	15	METAL
	018.20	EN-QAD1/10	7,5	10	1x [11÷15]	540	400	230	15	METAL
	018.21	EN-QAD1/12,5	9,2	12,5	1x [14÷19]	540	400	230	17	METAL
	018.22	EN-QAD1/15	11	15	1x [17÷23]	540	400	230	17	METAL
	018.23	EN-QAD1/20	15	20	1x [20÷29]	540	400	230	20	METAL
	018.24	EN-QAD1/25	18,5	25	1x [28÷37]	640	400	230	22	METAL
018.25	EN-QAD1/30	22	30	1x [35÷46]	640	400	230	24	METAL	



# EN-QAD 1



## SERIE EN-QAD 1

- Quadro elettromeccanico avviamento diretto elettropompa secondo normativa EN12845
- Fusibili di protezione
- Trasformatore 400 V/24 V per circuiti ausiliari
- Ingresso in bassissima tensione per comando da 2 pressostati in serie di chiamata/marcia (contatto NC con impianto in pressione e elettropompa ferma)
- Ingresso in bassissima tensione per comando elettropompa da galleggiante serbatoio adescamento (contatto NA con serbatoio pieno d'acqua)
- Ingresso in bassissima tensione per segnalazione da pressostato elettropompa in pressione/moto (contatto NA con impianto in pressione e elettropompa ferma)
- Selettore a chiave AUT-0-EMERGENZA: in posizione AUTOMATICO avviamento elettropompa tramite centralina elettronica in posizione EMERGENZA avviamento elettropompa istantaneo
- Centralina elettronica di gestione elettropompa
- Pulsanti MARCIA/ARRESTO elettropompa per test manuale
- Pulsante prova spie centralina
- Pulsante scorrimento funzioni centralina
- Display LCD retroilluminato per visualizzazione di 3 voltmetri di rete, 3 amperometri, frequenzimetro, wattmetro, varmetro, voltamperometro, cosfmetro, contaore totale, contaore parziale, storico eventi
- Spie di segnalazione
- Sistema di funzionamento secondo UNI10779 con temporizzazione di ritardo allo spegnimento elettropompa impostabile da 1 a 30'
- Possibilità di settare le visualizzazioni a display in 5 lingue: Italiano, Inglese, Spagnolo, Tedesco, Francese
- Funzioni di ritardo e allarmi specifici impostabili da centralina (fare riferimento al manuale allegato al quadro)
- Contattore di comando elettropompa dimensionato in AC4
- Sezionatore generale con blocco porta
- Uscita allarme con contatto in scambio (max 5A 250V AC1) per la segnalazione di "DISPONIBILITA' DELL'ALIMENTAZIONE ELETTRICA"
- Uscita allarme con contatto in scambio (max 5A 250V AC1) per la segnalazione di "RICHIESTA AVVIAMENTO POMPA"
- Uscita allarme con contatto in scambio (max 5A 250V AC1) per la segnalazione di "POMPA IN FUNZIONE"
- Uscita allarme con contatto in scambio (max 5A 250V AC1) per la segnalazione di "MANCATO AVVIAMENTO"

## EN-QAD 1 SERIES

- Electromechanical control panel for electric DOL pump according to EN12845
- Protection fuses
- Transformer 400 V/24 V for auxiliary circuit
- Very low voltage input for 2 pressure switches of start (NC contact with system in pressure and electric pump off)
- Very low voltage input for control of the electric pump from float switch in the priming tank (NO contact with tank full of water)
- Very low voltage input for signalling of electric pump in pressure/ on from pressure switch (NO contact with system in pressure and electric pump off)
- Selector with key AUT-0-EMERGENCY: in AUTOMATIC position starting of the pump by electronic unit in EMERGENCY position immediate starting of the pump
- Electronic unit for electric pump control
- Pushbuttons for STOP/START of the pump for manual test
- Pushbutton for test of the electronic unit's lights
- Pushbutton for scrolling the functions of the unit
- LCD Display for the visualization of 3 voltmeters, 3 ampmeters, frequencymeter, wattmeter, varmeter, volt-ampmeter, cosf-meter, total run meter, partial run meter, history of the events
- Signalling lights
- Operation mode according to UNI10779 with timer for delay of stop of the electric pump adjustable from 1' to 30'
- Visualizations of the display settable in 5 languages: Italian, English, Spanish, German, French
- Functions of delay and specific alarms settable from electronic unit (refer to the manual enclose to the panels)
- Contactor for control of the electric pump dimensioned in AC4
- Main switch with interlocking door
- Alarm output with exchangeable contact (max 5A 250V AC1) for signalling of "VOLTAGE SUPPLY AVAILABLE"
- Alarm output with exchangeable contact (max 5A 250V AC1) for signalling of "REQUEST FOR PUMP STARTING"
- Alarm output with exchangeable contact (max 5A 250V AC1) for signalling of "PUMP RUNNING"
- Alarm output with exchangeable contact (max 5A 250V AC1) for signalling of "START FAILED"

## SÉRIE EN-QAD 1

- Coffret électromécanique démarrage direct selon la norme EN 12845
- Fusibles de protection
- Transformateur 400/24V circuits auxiliaires
- Entrée à basse tension pour command de 2 pressostats de démarrage (contact NC avec système en pression et pompe arrêtée)
- Entrée à basse tension pour command de flotteur dans le réservoir d'amorçage (contact NO avec réservoir plein d'eau)
- Entrée à basse tension pour signal de pressostat pompe en pression marche(contact NO avec système en pression et pompe arrêtée)
- Sélecteur a clé AUT-0-EMERGENCE : en position AUTOMATIQUE démarrage de la pompe moyens de appareil électronique en position EMERGENCE démarrage de la pompe instantané
- Electronique de command pompe
- Boutons DEMARRAGE/ARRET pompe pour test manuel
- Bouton pour test d.e.l. électronique
- Bouton défilement fonctions de l'appareil électronique de contrôle
- Écran rétro-éclairé pour visualisation de 3 voltmètre, 3 ampèremètre, fréquence, wattmètre, varmètre, voltampèremètre, cosf-mètre, compteur total, compteur partiel, historique des événements
- Voyants de signalisation
- Système de fonctionnement UNI10779 avec temporisation de retard à l'extinction de la pompe réglable de 1' à 30'
- Visualisation du écran en 5 langues: italienne, anglaise, espagnole, allemande, française
- Fonctions de retard et alarmes spécifiques réglables par appareil électronique (voir au manuel annexe au coffret)
- Contacteur en AC4 pour le command de la pompe
- Sectionneur général avec verrouillage de la porte
- Sortie alarme avec contact en échange (max 5A 250V AC1) pour la signalisation de "DISPONIBILITÉ D'ALIMENTATION ÉLECTRIQUE"
- Sortie alarme avec contact en échange (max 5A 250V AC1) pour la signalisation de "DEMANDE DÉMARRAGE POMPE"
- Sortie alarme avec contact en échange (max 5A 250V AC1) pour la signalisation de "POMPE EN FONCTIONNEMENT"
- Sortie alarme avec contact en échange (max 5A 250V AC1) pour la signalisation de "MANQUÉ DÉMARRAGE"

# EN-QAST 1

Quadro elettrico per il comando dell'elettropompa antincendio principale (avviamento stella-triangolo) EN12845

Electrical panel for control of main electric fire-fighting pump (star-delta start-up) EN12845

Coffret électrique pour la commande de l'électropompe anti-incendie principale (démarrage étoile-triangle) EN12845

4 → 132 kW



foto indicative / indicative photos / photos indicatives



**Quadro elettrico per n.1 pompa**  
Control panel for n.1 pump  
Coffret électronique pour n.1 pompe

V	COD.	MODELLO / MODEL	POTENZA / POWER		CORRENTE / CURRENT	L x W x H			kg	box
			kW	Hp		H mm	L mm	W mm		
50/60 Hz					Nx [range] A					
3~400V	018.30	EN-QAST1/5,5	4	5,5	1x [8÷11]	540	400	230	7	METAL
	018.31	EN-QAST1/7,5	5,5	7,5	1x [10÷14]	540	400	230	7	METAL
	018.32	EN-QAST1/10	7,5	10	1x [10÷16]	540	400	230	9	METAL
	018.33	EN-QAST1/15	11	15	1x [15÷20]	540	400	230	9	METAL
	018.34	EN-QAST1/20	15	20	1x [24÷31]	640	400	230	18	METAL
	018.35	EN-QAST1/25	18,5	25	1x [24÷36]	640	400	230	18	METAL
	018.36	EN-QAST1/30	22	30	1x [34÷50]	640	400	230	18	METAL
	018.37	EN-QAST1/40	30	40	1x [48÷62]	740	500	230	22	METAL
	018.38	EN-QAST1/50	37	50	1x [60÷77]	740	500	230	36	METAL
	018.39	EN-QAST1/60	45	60	1x [79÷98]	740	500	230	36	METAL
	018.40	EN-QAST1/75	55	75	1x [93÷124]	740	500	230	46	METAL
	018.41	EN-QAST1/100	75	100	1x [125÷135]	840	600	330	46	METAL
	018.42	EN-QAST1/125	90	125	1x [125÷155]	1030	800	330	75	METAL
	018.43	EN-QAST1/150	110	150	1x [130÷195]	1030	800	330	75	METAL
018.44	EN-QAST1/180	132	180	1x [155÷240]	1030	800	330	80	METAL	

# EN-QAST 1



## SERIE EN-QAST 1

- Quadro elettromeccanico avviamento Stella-Triangolo elettropompa secondo normativa EN12845
- Fusibili di protezione
- Trasformatore 400 V/24 V per circuiti ausiliari
- Ingresso in bassissima tensione per comando da n2 pressostati in serie di chiamata/marcia (contatto NC con impianto in pressione e elettropompa ferma)
- Ingresso in bassissima tensione per comando elettropompa da galleggiante serbatoio adescamento (contatto NA con serbatoio pieno d'acqua)
- Ingresso in bassissima tensione per segnalazione da pressostato elettropompa in pressione/moto (contatto NA con impianto in pressione e elettropompa ferma)
- Selettore a chiave AUT-0-EMERGENZA: in posizione AUTOMATICO avviamento elettropompa tramite centralina elettronica in posizione EMERGENZA avviamento elettropompa istantaneo
- Centralina elettronica di gestione elettropompa
- Pulsanti MARCIA/ARRESTO elettropompa per test manuale
- Pulsante prova spie centralina
- Pulsante scorrimento funzioni centralina
- Display LCD retroilluminato per visualizzazione di 3 voltmetri di rete, 3 amperometri, frequenzimetro, wattmetro, varmetro, voltamperometro, cosmetro, contatore totale, contatore parziale, storico eventi
- Spie di segnalazione
- Sistema di funzionamento secondo UNI10779 con temporizzazione di ritardo allo spegnimento elettropompa impostabile da 1 a 30'
- Possibilità di settare le visualizzazioni a display in 5 lingue: Italiano, Inglese, Spagnolo, Tedesco, Francese
- Funzioni di ritardo e allarmi specifici impostabili da centralina (fare riferimento al manuale allegato al quadro)
- Contattori di comando elettropompa dimensionati in AC4
- Temporizzazione contattori Stella-Triangolo regolabile da centralina elettronica
- Sezionatore generale con blocco porta
- Uscita allarme con contatto in scambio (max 5A 250V AC1) per la segnalazione di "DISPONIBILITA' DELL'ALIMENTAZIONE ELETTRICA"
- Uscita allarme con contatto in scambio (max 5A 250V AC1) per la segnalazione di "RICHIESTA AVVIAMENTO POMPA"
- Uscita allarme con contatto in scambio (max 5A 250V AC1) per la segnalazione di "POMPA IN FUNZIONE"
- Uscita allarme con contatto in scambio (max 5A 250V AC1) per la segnalazione di "MANCATO AVVIAMENTO"

## EN-QAST 1 SERIES

- Electromechanical control panel for electric Star/Delta pump according to EN12845
- Protection fuses
- Transformer 400 V/24 V for auxiliary circuit
- Very low voltage input for 2 pressure switches of start(NC contact with system in pressure and electric pump off)
- Very low voltage input for control of the electric pump from float switch in the priming tank (NO contact with tank full of water)
- Very low voltage input for signalling of electric pump in pressure/on from pressure switch (NO contact with system in pressure and electric pump off)
- Selector with key AUT-0-EMERGENCY: in AUTOMATIC position starting of the pump by electronic unit in EMERGENCY position immediate starting of the pump
- Electronic unit for electric pump control
- Pushbuttons for STOP/START of the pump for manual test
- Pushbutton for test of the electronic unit's lights
- Pushbutton for scrolling the functions of the unit
- LCD Display for the visualization of 3 voltmeters, 3 amperometers, frequencymeter, wattmeter, varmeter, volt-ampmeter, cosmeter, total run meter, partial run meter, history of the events
- Signalling lights
- Operation mode according to UNI10779 with timer for delay of stop of the electric pump adjustable from 1' to 30'
- Visualizations of the display settable in 5 languages: Italian, English, Spanish, German, French
- Functions of delay and specific alarms settable from electronic unit (refer to the manual enclosure to the panels)
- Contactor for control of the electric pump dimensioned in AC4
- Main switch with interlocking door
- Alarm output with exchangeable contact (max 5A 250V AC1) for signalling of "VOLTAGE SUPPLY AVAILABLE"
- Alarm output with exchangeable contact (max 5A 250V AC1) for signalling of "REQUEST FOR PUMP STARTING"
- Alarm output with exchangeable contact (max 5A 250V AC1) for signalling of "PUMP RUNNING"
- Alarm output with exchangeable contact (max 5A 250V AC1) for signalling of "START FAILED"

## SÉRIE EN-QAST 1

- Coffret électromécanique démarrage étoile-triangle selon la norme EN 12845
- Fusibles de protection
- Transformateur 400/24V pour circuits auxiliaires
- Entrée à basse tension pour command de 2 pressostats de démarrage (contact NC avec système en pression et pompe arrêtée)
- Entrée à basse tension pour command de flotteur dans le réservoir d'amorçage (contact NO avec réservoir plein d'eau)
- Entrée à basse tension pour signal de pressostat pompe en pression/marche (contact NO avec système en pression et pompe arrêtée)
- Sélecteur a clé AUT-0-EMERGENCE : en position AUTOMATIQUE démarrage de la pompe moyens de appareil électronique en position EMERGENCE démarrage de la pompe instantané
- Electronique de command pompe
- Boutons DEMARRAGE/ARRET pompe pour test manuel
- Bouton pour test d.e.l. du électronique
- Bouton défilement fonctions de l'appareil électronique de contrôle
- Écran rétro-éclairé pour visualisation de 3 voltmètre, 3 ampèremètre, fréquence, wattmètre, varmètre, voltampèremètre, cosmètre, compteur total, compteur partiel, historique des événements
- Voyants de signalisation
- Système de fonctionnement UNI10779 avec temporisation de retard à l'extinction de la pompe réglable de 1' à 30'
- Visualisation du écran en 5 langues: italienne, anglaise, espagnole, allemande, française
- Fonctions de retard et alarmes spécifiques réglables par appareil électronique (voir au manuel annexe au coffret)
- Contacteur en AC4 pour le command de la pompe
- Temporisation contacteur étoile-triangle réglable par appareil électronique
- Sectionneur général avec verrouillage de la porte
- Sortie alarme avec contact en échange (max 5A 250V AC1) pour la signalisation de "DISPONIBILITÉ D'ALIMENTATION ÉLECTRIQUE"
- Sortie alarme avec contact en échange (max 5A 250V AC1) pour la signalisation de "DEMANDE DÉMARRAGE POMPE"
- Sortie alarme avec contact en échange (max 5A 250V AC1) pour la signalisation de "POMPE EN FONCTIONNEMENT"
- Sortie alarme avec contact en échange (max 5A 250V AC1) pour la signalisation de "MANQUÉ DÉMARRAGE"

# EN-QAVS 1

Quadro elettrico per il comando dell'elettropompa antincendio principale (avviamento ad impedenza) EN12845

Electrical panel for control of main electric fire-fighting pump (impedance start-up) EN12845

Coffret électrique pour la commande de l'électropompe anti-incendie principale (démarrage à impédance) EN12845

4 → 132 kW



**Quadro elettrico per n.1 pompa**  
Control panel for n.1 pump  
Coffret électronique pour n.1 pompe

V	COD.	MODELLO / MODEL	POTENZA / POWER		CORRENTE / CURRENT	L x W x H			kg	box
			kW	Hp		H mm	L mm	W mm		
50/60 Hz					Nx [range] A					
3~400V	018.50	EN-QAVS1/5,5	4	5,5	1x [8÷11]	740	500	230	21	METAL
	018.51	EN-QAVS1/7,5	5,5	7,5	1x [10÷14]	740	500	230	21	METAL
	018.52	EN-QAVS1/10	7,5	10	1x [10÷16]	740	500	230	23	METAL
	018.53	EN-QAVS1/15	11	15	1x [15÷20]	740	500	230	25	METAL
	018.54	EN-QAVS1/20	15	20	1x [24÷31]	740	500	230	38	METAL
	018.55	EN-QAVS1/25	18,5	25	1x [24÷36]	840	600	330	38	METAL
	018.56	EN-QAVS1/30	22	30	1x [34÷50]	840	600	330	43	METAL
	018.57	EN-QAVS1/40	30	40	1x [48÷62]	840	600	330	43	METAL
	018.58	EN-QAVS1/50	37	50	1x [60÷77]	840	600	330	54	METAL
	018.59	EN-QAVS1/60	45	60	1x [79÷98]	840	600	330	82	METAL
	018.60	EN-QAVS1/75	55	75	1x [93÷124]	1030	800	330	124	METAL
	018.61	EN-QAVS1/100	75	100	1x [125÷135]	1240	800	330	128	METAL
	018.62	EN-QAVS1/125	90	125	1x [125÷155]	1240	800	330	128	METAL
	018.63	EN-QAVS1/150	110	150	1x [130÷195]	1600	800	430	230	METAL
018.64	EN-QAVS1/180	132	180	1x [155÷240]	1600	800	430	270	METAL	

# EN-QAVS 1



## SERIE EN-QAVS 1

- Quadro elettromeccanico avviamento Statorico elettropompa secondo normativa EN12845
- Fusibili di protezione
- Trasformatore 400 V/24 V per circuiti ausiliari
- Ingresso in bassissima tensione per comando da 2 pressostati in serie di chiamata/marcia (contatto NC con impianto in pressione e elettropompa ferma)
- Ingresso in bassissima tensione per comando elettropompa da galleggiante serbatoio adescamento (contatto NA con serbatoio pieno d'acqua)
- Ingresso in bassissima tensione per segnalazione da pressostato elettropompa in pressione/moto (contatto NA con impianto in pressione e elettropompa ferma)
- Selettore a chiave AUT-0-EMERGENZA : in posizione AUTOMATICO avviamento elettropompa tramite centralina elettronica in posizione EMERGENZA avviamento elettropompa istantaneo
- Centralina elettronica di gestione elettropompa
- Pulsanti MARCIA/ARRESTO elettropompa per test manuale
- Pulsante prova spie centralina
- Pulsante scorrimento funzioni centralina
- Display LCD retroilluminato per visualizzazione di 3 voltmetri di rete, 3 amperometri, frequenzimetro, wattmetro, varmetro, voltampmetro, cosmetro, contaore totale, contaore parziale, storico eventi
- Spie di segnalazione
- Sistema di funzionamento secondo UNI10779 con temporizzazione di ritardo allo spegnimento elettropompa impostabile da 1 a 30'
- Possibilità di settare le visualizzazioni a display in 5 lingue: Italiano, Inglese, Spagnolo, Tedesco, Francese
- Funzioni di ritardo e allarmi specifici impostabili da centralina (fare riferimento al manuale allegato al quadro)
- Contattori di comando elettropompa dimensionati in AC4
- Temporizzazione contattori Avviamento Statorico regolabile da centralina elettronica
- Impedenza di avviamento motore
- Fusibili ad alta capacità di rottura di protezione motore
- Sezionatore generale con blocco porta
- Uscita allarme con contatto in scambio (max 5A 250V AC1) per la segnalazione di "DISPONIBILITA' DELL'ALIMENTAZIONE ELETTRICA"
- Uscita allarme con contatto in scambio (max 5A 250V AC1) per la segnalazione di "RICHIESTA AVVIAMENTO POMPA"
- Uscita allarme con contatto in scambio (max 5A 250V AC1) per la segnalazione di "POMPA IN FUNZIONE"
- Uscita allarme con contatto in scambio (max 5A 250V AC1) per la segnalazione di "MANCATO AVVIAMENTO"

## EN-QAVS 1 SERIES

- Electromechanical control panel for Statoric Impedance pump according to EN12845
- Protection fuses
- Transformer 400 V/24 V for auxiliary circuit
- Very low voltage input for 2 pressure switches of start (NC contact with system in pressure and electric pump off)
- Very low voltage input for control of the electric pump from float switch in the priming tank (NO contact with tank full of water)
- Very low voltage input for signalling of electric pump in pressure/on from pressure switch (NO contact with system in pressure and electric pump off)
- Selector with key AUT-0-EMERGENCY : in AUTOMATIC position starting of the pump by electronic unit in EMERGENCY position immediate starting of the pump
- Electronic unit for electric pump control
- Pushbuttons for STOP/START of the pump for manual test
- Pushbutton for test of the electronic unit's lights
- Pushbutton for scrolling the functions of the unit
- LCD Display for the visualization of 3 voltmeters, 3 amperemeters, frequencymeter, wattmeter, varmeter, volt-amp-meter, cosfmeter, total run meter, partial run meter, history of the events
- Signalling lights
- Operation mode according to UNI10779 with timer for delay of stop of the electric pump adjustable from 1' to 30'
- Visualizations of the display settable in 5 languages: Italian, English, Spanish, German, French
- Functions of delay and specific alarms settable from electronic unit (refer to the manual enclose to the panels)
- Contactor for control of the electric pump dimensioned in AC4
- Timing of contactors for Statoric Start settable from electronic unit Impedance for motor start
- Motor starting impedance
- High resistance fuses for motor protection
- Main switch with interlocking door
- Alarm output with exchangeable contact (max 5A 250V AC1) for signalling of "VOLTAGE SUPPLY AVAILABLE"
- Alarm output with exchangeable contact (max 5A 250V AC1) for signalling of "REQUEST FOR PUMP STARTING"
- Alarm output with exchangeable contact (max 5A 250V AC1) for signalling of "PUMP RUNNING"
- Alarm output with exchangeable contact (max 5A 250V AC1) for signalling of "START FAILED"

## SÉRIE EN-QAVS 1

- Coffret électromécanique démarrage statorique selon la norme EN 12845
- Fusibles de protection
- Transformateur 400V/24V pour circuits auxiliaires
- Entrée à basse tension pour command de 2 pressostats de démarrage (contact NC avec système en pression et pompe arrêtée)
- Entrée à basse tension pour command de flotteur dans le réservoir d'amorçage (contact NO avec réservoir plein d'eau)
- Entrée à basse tension pour signal de pressostat pompe en pression/marche (contact NO avec système en pression et pompe arrêtée)
- Sélecteur a clé AUT-0-EMERGENCE : en position AUTOMATIQUE démarrage de la pompe moyens de appareil électronique en position EMERGENCE démarrage de la pompe instantané
- Electronique de command pompe
- Boutons DEMARRAGE/ARRET pompe pour test manuel
- Bouton pour test d.e.l. du électronique
- Bouton défilement fonctions de l'appareil électronique de contrôle
- Écran rétro-éclairé pour visualisation de 3 voltmètre, 3 ampèremètre, fréquence, wattmètre, varmètre, voltampèremètre, cosfmètre, compteur total, compteur partiel, historique des événements
- Voyants de signalisation
- Système de fonctionnement UNI10779 avec temporisation de retard à l'extinction de la pompe réglable de 1' à 30'
- Visualisation du écran en 5 langues: italienne, anglaise, espagnole, allemande, française
- Fonctions de retard et alarmes spécifiques réglables par appareil électronique (voir au manuel annexe au coffret)
- Contacteur en AC4 pour le command de la pompe
- Temporisation des contacteurs statoriques réglable par appareil électronique
- Impédance de démarrage du moteur
- Fusibles à capacité de coupure élevée de la protection du moteur
- Sectionneur général avec verrouillage de la porte
- Sortie alarme avec contact en échange (max 5A 250V AC1) pour la signalisation de "DISPONIBILITÉ D'ALIMENTATION ÉLECTRIQUE"
- Sortie alarme avec contact en échange (max 5A 250V AC1) pour la signalisation de "DEMANDE DÉMARRAGE POMPE"
- Sortie alarme avec contact en échange (max 5A 250V AC1) pour la signalisation de "POMPE EN FONCTIONNEMENT"
- Sortie alarme avec contact en échange (max 5A 250V AC1) pour la signalisation de "MANQUÉ DÉMARRAGE"

# EN-QAM 1

Quadro elettrico di avviamento motopompa antincendio principale EN12845

Electrical panel for start-up of main diesel fire-fighting pump EN12845

Coffret électrique de démarrage de la motopompe principale diesel anti-incendie EN12845

4 → 132 kW



**Quadro elettrico per n.1 pompa**  
Control panel for n.1 pump  
Coffret électronique pour n.1 pompe

V	COD.	MODELLO / MODEL	POTENZA / POWER		L x W x H			kg	box
			kW	Hp	H mm	L mm	W mm		
50/60 Hz									
3~400V	018.12	EN-QAM1	4÷132	5,5÷180	500	400	230	15	METAL
	018.13	EN-QAM1 RELÈ	4÷132	5,5÷180	700	500	230	15	METAL

# EN-QAM 1



## SERIE EN-QAM 1

- Quadro elettromeccanico avviamento motopompa secondo normativa EN12845
- Fusibili di protezione
- Ingresso da n.2 Accumulatori al piombo esterni per comando motorino d'avviamento ed alimentazione circuiti ausiliari
- Ingresso in bassissima tensione per comando da 2 pressostati in serie di chiamata/marcia (contatto NC con impianto in pressione e Motopompa ferma)
- Ingresso in bassissima tensione per comando Motopompa da galleggiante serbatoio adescamento (contatto NA con serbatoio pieno d'acqua)
- Ingresso in bassissima tensione per segnalazione da pressostato Motopompa in pressione/moto (contatto NA con Motopompa ferma)
- Centralina elettronica di gestione Motopompa
- Selettore a chiave AUT-MAN posizione AUTOMATICO avviamento motopompa tramite centralina elettronica, in posizione MANUALE avviamento motopompa da pulsante Start centralina
- Pulsanti di avviamento manuale Motopompa
- Pulsante di arresto manuale Motopompa
- Pulsante di ripristino anomalie
- Pulsante prova avviamento manuale (attivo in caso di mancato avviamento automatico)
- Pulsante prova spie centralina
- Pulsante scorrimento funzioni centralina
- Pulsanti di avviamento di Emergenza Manuale protetti da "Safe crash"
- Display LCD retroilluminato per visualizzazione di 2 voltmetri batterie, 2 amperometri batterie, contagiri, contaore totale, contaore parziale, indicatore livello combustibile, termometro acqua, termometro olio, manometro olio, contavviamenti da batterie e storico eventi
- Spie di segnalazione
- Sistema di funzionamento secondo UNI10779 con temporizzazione di ritardo allo spegnimento elettropompa impostabile da 1 a 30'
- Possibilità di settare le visualizzazioni a display in 5 lingue: Italiano, Inglese, Spagnolo, Tedesco, Francese
- Funzioni di ritardo e allarmi specifici impostabili da centralina (fare riferimento al manuale allegato al quadro)
- 2 caricabatteria 12Vdc 3A (24Vdc 3A per versione a 24V) per il mantenimento accumulatori
- Sezionatore generale con blocco porta
- Uscita allarme con contatto in scambio (max 5A 250V AC1) per la segnalazione di "MODALITA' AUTOMATICA ESCLUSA"
- Uscita allarme con contatto in scambio (max 5A 250V AC1) per la segnalazione di "GUASTO DEL QUADRO DI CONTROLLO"
- Uscita allarme con contatto in scambio (max 5A 250V AC1) per la segnalazione di "MOTOPOMPA IN FUNZIONE"
- Uscita allarme con contatto in scambio (max 5A 250V AC1) per la segnalazione di "MANCATO AVVIAMENTO"

## EN-QAM 1 SERIES

- Electromechanical control panel for diesel pump according to EN12845
- Protection fuses
- Input from 2 external lead batteries for control of the starting motor and supply of auxiliary circuits
- Very low voltage input for control from n° 2 call/start pressure switches in series (NC contact with system in pressure and diesel pump stopped)
- Very low voltage input for control of the diesel pump from float switch in the priming tank (NO contact with tank full of water)
- Very low voltage input for signalling of electric pump in pressure/on from pressure switch (NO contact with diesel pump off)
- Electronic unit for diesel pump control
- Selector with key AUT-MAN: in AUTOMATIC position starting of the diesel pump by electronic unit, in MANUAL position starting of the diesel pump by Start pushbutton of the electronic unit
- Pushbuttons for manual start of the diesel pump
- Pushbutton for manual shut off of the diesel pump
- Pushbutton for restoring from anomalies
- Pushbutton for testing the manual start (active in case of failure of automatic start)
- Pushbutton for test of the electronic unit's lights
- Pushbutton for scrolling the functions of the unit
- Pushbuttons for Manual Emergency protected by "Safe crash"
- LCD Display for the visualization of 2 batteries voltmeters, 2 batteries ampmeters, round meters, total run meter, partial run meter, indicator of fuel level, water thermometer, oil thermometer, oil manometer, batteries starting counter, history of the events
- Signalling lights
- Operation mode according to UNI10779 with timer for delay of stop of the electric pump adjustable from 1' to 30'
- Visualizations of the display settable in 5 languages: Italian, English, Spanish, German, French
- Functions of delay and specific alarms settable from electronic unit (refer to the manual enclose to the panels)
- 2 battery chargers 12Vdc 3A (24Vdc 3A for 24V version) Auxiliary protection fuses
- Main switch with interlocking door
- Alarm output with exchangeable contact (max 5A 250V AC1) for signalling of "AUTOMATIC OPERATION EXCLUDED"
- Alarm output with exchangeable contact (max 5A 250V AC1) for signalling of "CONTROL PANEL BREAKDOWN"
- Alarm output with exchangeable contact (max 5A 250V AC1) for signalling of "DIESEL PUMP OPERATING"
- Alarm output with exchangeable contact (max 5A 250V AC1) for signalling of "START FAILED"

## SÉRIE EN-QAM 1

- Coffret électromécanique démarrage diesel pompe selon la norme EN 12845
- Fusibles de protection
- Entrée de 2 batteries au plomb extérieurs pour command de moteur de démarrage et alimentation circuits auxiliaires
- Entrée à basse tension pour command de 2 pressostats de démarrage (contact NC avec système en pression et pompe arrêtée)
- Entrée à basse tension pour command de flotteur dans le réservoir d'amorçage (contact NO avec réservoir plein d'eau)
- Entrée à basse tension pour signal de pressostat pompe en pression/marche (contact NO avec système en pression et pompe arrêtée)
- Electronique de command pompe
- Sélecteur a clé AUT-MAN: en position AUTOMATIQUE démarrage de la pompe moyens de appareil électronique en position MANUEL démarrage de la pompe de bouton START
- Bouton de démarrage pompe manuel
- Bouton d'arrêt pompe manuel
- Bouton de rétablissement anomalies
- Bouton pour test de démarrage manuel (actif en cas de démarrage automatique manqué)
- Bouton pour test d.e.l. du électronique
- Bouton défilement fonctions de l'appareil électronique de contrôle
- Boutons de démarrage manuel d'urgence protégés avec «Safe Crash»
- Écran rétro-éclairé pour visualisation de 2 voltmètres batteries, 2 ampèremètre batteries, compte tours, compteur total, compteur partiel, indication du nivel du combustible, thermomètre pour l'eau, thermomètre pour l'œil, manomètre de l'œil, compte des démarrages batteries et historique des événements
- Voyants de signalisation
- Système de fonctionnement UNI10779 avec temporisation de retard à l'extinction de la pompe réglable de 1' à 30'
- Visualisation du écran en 5 langues: italienne, anglaise, espagnole, allemande, française
- Fonctions de retard et alarmes spécifiques réglables par appareil électronique (voir au manuel annexe au coffret)
- Contacteur en AC4 pour le command de la pompe 2 chargeurs de batteries 12Vdc 3A (24 Vdc 3A pour modèle en 24V)
- Sectionneur général avec verrouillage de la porte
- Sortie alarme avec contact en échange (max 5A 250V AC1) pour la signalisation de "MODALITÉ AUTOMATIQUE EXCLUE"
- Sortie alarme avec contact en échange (max 5A 250V AC1) pour la signalisation de "ÉCHEC DU COFFRET DE CONTROL"
- Sortie alarme avec contact en échange (max 5A 250V AC1) pour la signalisation de "MOTOPOMPE EN FONCTIONNEMENT"
- Sortie alarme avec contact en échange (max 5A 250V AC1) pour la signalisation de "MANQUÉ DÉMARRAGE"

# SENTINEL



Quadro evoluto di controllo e protezione Gruppo elettrogeno con commutazione automatica

Advanced control and protection panel for Genset with automatic switching

Coffret de commande et de protection évolué pour Groupes électrogènes avec commutation automatique

11 → 1100 kVA



COD.	MODELLO / MODEL		230V 1~			400V 3N~						
			Vdc	max kVA	max A (AC1)	max kVA	max A (AC1)	H mm	L mm	W mm	kg	box
801.02	<b>S2</b>	<b>SENTINEL 2</b>	12	11	50	22	32	600	400	200	20	METAL
801.03	<b>S3</b>	<b>SENTINEL 3</b>	12	16	72	31	45	600	400	200	21	METAL
801.04	<b>S4</b>	<b>SENTINEL 4</b>	12	22	96	41	60	600	400	200	21	METAL
801.05	<b>S5</b>	<b>SENTINEL 5</b>	12	33	144	61	90	700	500	250	34	METAL
801.06	<b>S6</b>	<b>SENTINEL 6</b>	12	40	176	75	110	700	500	250	34	METAL
801.07	<b>S7</b>	<b>SENTINEL 7</b>	12	46	200	85	125	700	500	250	34	METAL
801.08	<b>S8</b>	<b>SENTINEL 8</b>	12	-	-	110	160	700	500	250	46	METAL
801.09	<b>S9</b>	<b>SENTINEL 9</b>	12	-	-	138	200	700	500	250	46	METAL
801.10	<b>S10</b>	<b>SENTINEL 10</b>	12	-	-	170	250	700	500	250	47	METAL
801.11	<b>S11</b>	<b>SENTINEL 11</b>	12	-	-	217	315	800	600	300	51	METAL
801.12	<b>S12</b>	<b>SENTINEL 12</b>	12	-	-	275	400	800	600	300	55	METAL
801.13	<b>S13</b>	<b>SENTINEL 13</b>	24	-	-	435	630	1000	800	300	79	METAL
801.14	<b>S14</b>	<b>SENTINEL 14</b>	24	-	-	550	800	1500	800	400	120	METAL
801.15	<b>S15</b>	<b>SENTINEL 15</b>	24	-	-	690	1000	1500	800	400	160	METAL
801.16	<b>S16</b>	<b>SENTINEL 16</b>	24	-	-	860	1250	1500	800	400	165	METAL
801.17	<b>S17</b>	<b>SENTINEL 17</b>	24	-	-	1100	1600	1500	800	400	170	METAL



# SENTINEL



## SERIE SENTINEL

- Fusibili di protezione
- Ingresso rete 3N~50/60Hz 400V
- Ingresso gruppo 3N~50/60Hz 400V
- Uscita motore 3N~50/60Hz 400V
- Ingresso da batteria gruppo
- Ingresso per alternatori a pre-eccitazione magneti permanenti
- Ingresso allarmi (riserva, pressione olio e temperatura motore)
- Uscite comando con servo relè interno (motorino di avviamento, arresto e candele)
- Telecommutazione Rete-Gruppo
- Pulsante a fungo di emergenza
- Caricabatteria automatico mantenimento batteria gruppo
- Fusibili di protezione ausiliari
- Centralina di protezione motore a microprocessore CAM-333 con le seguenti funzioni:
  - sorveglianza automatica delle anomalie con messaggi sul display
  - testi in 5 lingue: italiano, inglese, francese, tedesco e spagnolo
  - indicazioni di 4 manutenzioni periodiche programmabili con visualizzazione delle ore rimanenti prima dello scadere della manutenzione stessa
  - comandi remoti a contatti (avviamento e arresto)
  - orologio per programmare l'avviamento o il blocco del gruppo elettrogeno
  - telegestione remota con possibilità dell'utilizzo di un modem gsm
  - programmazione dei parametri (soglia, tempi, conteggi, etc.) facilitate da interruttori a levetta
  - autotest settimanale programmabile
  - anomalie disponibili completamente programmabili (tempi, polarità, possibilità di arresto e messaggio relativo all'anomalia)
- 3 trasformatori amperometrici per lettura corrente
- Alimentazione per scaldiglia
- Uscita allarme 5A 250V (COM-NA-NC)
- 2 ingressi disponibili per allarmi (programmabili)

## SENTINEL SERIES

- Protection fuses
- Mains input 3N~50/60Hz 400v +/-10%
- Generator input 3N~50/60Hz 400v +/-10%
- Output 3N~50/60Hz 400v +/-10%
- Input from generator's battery
- Input for pre-excited permanent magnets alternators
- Alarms input (Empty Fuel, Oil Pressure and Motor Temperature)
- Output with internal relays (Starting System, Stop and Spark Plugs)
- Auto changeover Mains-Generator
- Mushroom-head pushbutton
- Automatic battery charger for generator's battery
- Auxiliaries protection fuses
- Motor protection system with microprocessor CAM-333 with the following functions:
  - automatic surveillance of anomalies with messages on the display
  - text available in 5 languages: Italian, English, French, German and Spanish
  - indications of 4 periodical maintenances with visualization of the remaining hours before the expiry of the maintenance
  - remote controls with contacts (start and stop)
  - timer for programming start or stop of the generator
  - remote control with modem gsm
  - parameters set up (threshold, times, counters, etc.) with levers
  - weekly autotest
  - settable anomalies (times, polarity, stop and message related to anomaly)
- 3 ammetric transformers for reading of the current;
- Heater voltage supply
- Alarm output 5A 250V (COM-NO-NC)
- 2 inputs available for alarms (settable)

## SÉRIE SENTINEL

- Fusibles de protection
- Alimentation de réseau 3N~50/60Hz 400v +/-10%
- Alimentation de générateur 3N~50/60Hz 400v +/-10%
- Sortie utilisateur 3N~50/60Hz 400v +/-10%
- Entrée de batterie du générateur
- Entrée pour alternateurs à pre-excitation ou alternateur aimants permanents
- Entrée alarmes (Réserve, Pression huile et Température moteur)
- Sorties commande (Moteur de démarrage, arrêt et bougies)
- Telecommutation Réseau-Groupe
- Bouton d'urgence
- Chargeur automatique des batteries du générateur
- Fusibles de protection auxiliaires
- Centrale électronique à microprocesseur CAM-333 avec les fonctions suivantes:
  - surveillance automatique des anomalies avec messages sur écran
  - texte en 5 langues: italienne, anglais, française, allemande et espagnole
  - indications de 4 maintenances périodiques programmables avec visualisation des heures restantes avant expirer du maintenance
  - commandes à distance avec contacts (démarrage et arrêt)
  - horloge pour programmer le démarrage ou l'arrêt du groupe électrogène
  - commande à distance avec possibilité d'utiliser un modem gsm
  - programmation des paramètres (seuil, temps, comptes, etc.)
  - autotest hebdomadaire programmable
  - anomalies programmables (temps, polarité, possibilité d'arrêt et message des anomalies)
- 3 transformateurs ampérométriques pour lecture du courant
- Alimentation pour chauffe
- Sortie alarme 5A 250V (COM-NA-NC)
- 2 entrées disponibles pour alarmes (programmables)

# QCM

## Quadro comando automatico motopompa diesel

Automatic diesel pump control panel

Panneau de commande automatique pour une pompe à moteur diesel



foto indicative / indicative photos / photos indicatives

## SERIE QCM

- Fusibili di protezione
- Alimentazione da rete: monofase 230Vac
- Alimentazione da batteria: 12V o 24V
- Display con strumenti digitali (voltmetro batteria, contaore totale, contaore parziale, conta avviamenti, conta mancati avviamenti, indicatore livello combustibile, contagiri)
- Menu multilingua con storico anomalie
- Comando remoto (avviamento e arresto)
- 4 Relè uscita preriscaldamento/raffreddamento motore/avviamento/arresto/uscita allarme
- Orologio programmabile
- Autotest settimanale programmabile
- Ingresso per anomalia programmabile
- Possibilità di avvio motore con batteria in riserva di carica
- Carica batterie automatico interno

## QCM SERIES

- Protection fuses
- Mains input single phase 230Vac
- Main input battery: 12V or 24V
- Display with digital instruments (battery voltmeter, total hour meter, partial hour meter, starting counter, starting failures counter, fuel level indicator, tachometer)
- Multilanguage menu with anomaly historical
- Remote control (start and stop)
- 4 relay preheating/motor cooling/starter/stop/ alarm output
- Programmable clock
- Programmable weekly selftest
- Programmable input for anomaly
- Possibility of starting the motor when the charge of the battery is low
- Internal automatic battery charger

## SÉRIE QCM

- Fusibles de protection
- Alimentation: monophasé 230Vac
- Alimentation par batterie: 12V ou 24V
- Écran avec instruments numériques (voltmètre de batterie, compt.horaire total, compt.horaire partiel, compte de départ, nombre de démarrages ratés, indicateur de niveau de carburant, tachymètre)
- Menu multilingue avec anomalies historiques
- Commande à distance (démarrer et arrêter)
- 4 relais de préchauffage/refroidissement du moteur/démarrage/d'arrête/d'allarme
- Horloge programmable
- Auto-test hebdomadaire programmable
- Entrée pour anomalie programmable
- Possibilité de démarrer le moteur avec batterie en réserve de marche
- Chargeur de batterie automatique interne



V	COD.	MODELLO / MODEL	BATTERIA / BATTERY	L x W x H			kg	box
				H mm	L mm	W mm		
50/60 Hz			V					
1~230V	005.99	QCM/12	12 Vdc	530	400	230	12	METAL
	006.00	QCM/24	24 Vdc	530	400	230	12	METAL

# LP2000/SHUTTLE

Strumento di misura e regolazione di livello con sensore analogico 4÷20mA

Measuring instrument and level regulator with analogic 4÷20mA sensor

Instrument de mesure et de régulation de niveau avec un capteur analogique 4÷20mA

foto indicative / indicative photos / photos indicatives



LP2000



SHUTTLE 4D

## SERIE LP2000

- Alimentazione 24V 50Hz ±10%
- Ingresso per sensore 4÷20mA
- Campo di misura 0÷10 metri
- Display a 4 cifre per visualizzazione livello (cm)
- 2 uscite a relè programmabili
- Circuito di alternanza motori

## SERIE SHUTTLE 4D

- Alimentazione 1~230V 50/60Hz ±10%
- Ingresso per sensore 4÷20mA
- Display LCD programmazione/visualizzazioni
- 4 uscite a relè programmabili
- Ritardatori d'intervento indipendenti
- Funzionamento ciclico o alternato 2/3/4 utenze
- Datalogger incorporato
- Porta seriale RS 232

## LP2000 SERIES

- Power input 24V 50Hz ±10%
- Input for sensor 4÷20mA
- Sensor range 0÷10 meter
- Display with 4 numbers for level visualization (cm)
- 2 output programmable relays
- Motors exchangeover

## SHUTTLE 4D SERIES

- Power input 1~230V 50/60Hz ±10%
- Input of sensor 4÷20mA
- LCD programming/visualizations
- 2 output programmable relays
- Independent delayers of intervention
- Cyclic or alternate operation 2/3/4 users
- Datalogger included
- Serial port RS 232

## SÉRIE LP2000

- Alimentation 24V 50Hz ±10%
- Entrée capteur 4÷20mA
- Plage de mesure 0÷10 mètres
- Écran 4 chiffres pour l'affichage du niveau (cm)
- 2 sorties relays programmable
- Circuit de l'échange motors

## SÉRIE SHUTTLE 4D

- Alimentation 1~230V 50/60Hz ±10%
- Entrée capteur 4÷20mA
- Écran LCD programmation/visualisation
- 2 sorties relays programmable
- Retardateurs d'intervention indépendants
- Fonctionnement cyclique ou alterné 2/3/4 usages
- Enregistreur de données incorporé
- Port série RS 232



COD.	MODELLO / MODEL	L-W-H			kg
		H mm	L mm	W mm	
108.05	LP2000	96	48	150	1
106.17	SHUTTLE 4D	240	185	115	2

# ACCESSORI

Accessori  
Accessories  
Accessoires

**INVOLUCRO PLASTICO IP55 IN ABS**  
PLASTIC ABS BOX IP55  
BOITIER PLASTIQUE IP55 EN ABS



COD.	MODELLO MODEL	L-W-H		
		H mm	L mm	W mm
103.02	<b>BOX3P</b>	310	240	150
103.03	<b>BOX4P</b>	380	300	120

**INVOLUCRO VETRORESINA IP65** | **Singola porta cieca**  
FIBREGLASS BOX IP65 | Single blind door  
BOITIER FIBRES DE VERRE IP65 | Une porte opaque



COD.	MODELLO MODEL	L-W-H		
		H mm	L mm	W mm
103.20	<b>BOX1VT</b>	425	325	180
103.21	<b>BOX2VT</b>	500	430	210
103.22	<b>BOX3VT</b>	650	430	210
103.23	<b>BOX4VT</b>	650	540	260
103.24	<b>BOX5VT</b>	805	615	315
103.25	<b>BOX6VT</b>	1060	810	355

**INVOLUCRO VETRORESINA IP65** | **Doppia porta trasparente**  
FIBREGLASS BOX IP65 | Double transparent door  
BOITIER FIBRES DE VERRE IP65 | Double porte transparente



COD.	MODELLO MODEL	L-W-H		
		H mm	L mm	W mm
103.20T	<b>BOX1VDPT</b>	425	325	180
103.21T	<b>BOX2VDPT</b>	500	430	210
103.22T	<b>BOX3VDPT</b>	650	430	210
103.23T	<b>BOX4VDPT</b>	650	540	260
103.24T	<b>BOX5VDPT</b>	805	615	315
103.25T	<b>BOX6VDPT</b>	1060	810	355

**INVOLUCRO VETRORESINA IP65** | **Doppia porta cieca**  
FIBREGLASS BOX IP65 | Double blind door  
BOITIER FIBRES DE VERRE IP65 | Double porte opaque



COD.	MODELLO MODEL	L-W-H		
		H mm	L mm	W mm
103.20C	<b>BOX1VDPC</b>	425	325	180
103.21C	<b>BOX2VDPC</b>	500	430	210
103.22C	<b>BOX3VDPC</b>	650	430	210
103.23C	<b>BOX4VDPC</b>	650	540	260
103.24C	<b>BOX5VDPC</b>	805	615	315
103.25C	<b>BOX6VDPC</b>	1060	810	355

**INVOLUCRO METALLICO IP55** | **Singola porta cieca**  
METAL BOX IP55 | Single blind door  
BOITIER METALLIQUE IP55 | Une porte opaque



COD.	MODELLO MODEL	L-W-H		
		H mm	L mm	W mm
103.10	<b>BOX1M</b>	400	300	200
103.11	<b>BOX2M</b>	500	400	200
103.12	<b>BOX3M</b>	600	400	200
103.13	<b>BOX4M</b>	700	500	250
103.14	<b>BOX5M</b>	800	600	300
103.15	<b>BOX6M</b>	1000	800	300
103.16	<b>BOX7M</b>	1200	800	300

**INVOLUCRO METALLICO IP65** | **Doppia porta trasparente**  
METAL BOX IP65 | Double transparent door  
BOITIER METALLIQUE IP65 | Double porte transparente



COD.	MODELLO MODEL	L-W-H		
		H mm	L mm	W mm
108.32	<b>BOX2MDPT</b>	500	400	200
108.33	<b>BOX3MDPT</b>	600	400	200
108.35	<b>BOX5MDPT</b>	800	600	300

**INVOLUCRO METALLICO IP65** | **Doppia porta cieca**  
METAL BOX IP65 | Double blind door  
BOITIER METALLIQUE IP65 | Double porte opaque



COD.	MODELLO MODEL	L-W-H		
		H mm	L mm	W mm
108.131	<b>BOX2MDPC</b>	500	400	200
108.14	<b>BOX3MDPC</b>	600	400	200
108.16	<b>BOX5MDPC</b>	800	600	300

**KIT FISSAGGIO A PAVIMENTO**  
FLOOR FIXING KIT  
KIT FIXATION SUR PLANCHER



COD. 103.19 COD. 103.26

COD.	MODELLO MODEL	L-W-H		
		H mm	L mm	W mm
103.19	<b>KIT-ZOCC</b>	100	-	-
103.26	<b>KIT-PIANT</b>	800	350	165

## ACCESSORI

Accessori  
Accessories  
Accessoires

## CASSA STRADALE IN VETRORESINA IP44

FIBREGLASS ROAD BOX IP44

BOITIER ROUTIERS EN FIBRES DE VERRE IP44



COD.	MODELLO / MODEL	INTERNO INTERNAL			ESTERNO EXTERNAL		
		H mm	L mm	W mm	H mm	L mm	W mm
108.40	<b>QVT60</b>	873	517	260	900	546	308
108.41	<b>QVT80</b>	1365	640	375	1760	720	450
108.42	<b>QVT120</b>	1715	1055	375	1750	1135	450

## CASSA IN POLICARBONATO IP65

POLYCARBONATE BOX IP65

BOITIER EN POLYCARBONATE IP65



COD.	MODELLO / MODEL	INTERNO INTERNAL			ESTERNO EXTERNAL		
		H mm	L mm	W mm	H mm	L mm	W mm
108.43	<b>QPZ663</b>	450	500	265	600	600	300
108.44	<b>QPZ963</b>	750	500	265	900	600	300
108.45	<b>QPZ983</b>	750	750	265	900	850	300
108.46	<b>QPZ1283</b>	1050	750	265	1200	850	300
108.47	<b>QPZ12113</b>	1050	1000	265	1200	1100	300

## ARMADIO IP55

BOX IP55

ARMOIRE IP55

Due vani separati

Two separate compartments

Deux chambres separees



COD.	MODELLO / MODEL	INTERNO INTERNAL			ESTERNO EXTERNAL			
		H mm	L mm	W mm	H mm	L mm	W mm	
108.84	<b>BOX2V1840</b>	A	883	562	428	1840	580	460
		B	523	562	428			
108.85	<b>BOX2V1390</b>	A	523	562	298	1390	580	330
		B	433	562	298			

## ARMADIO DI METALLO IP55

METAL CABINET IP55

ARMOIRE METALLIQUE IP55

Singola porta cieca

Single blind door

Une porte opaque



COD.	MODELLO / MODEL	+ZOCICOLO +PLINTH		
		H mm	L mm	W mm
108.86	<b>BOX1500PC</b>	1400	800	400
108.88	<b>BOX1700PC</b>	1600	800	400
108.90	<b>BOX1900PC</b>	1800	800	400
108.93	<b>BOX2100PC</b>	2000	800	400

## ARMADIO DI METALLO IP55

METAL CABINET IP55

ARMOIRE METALLIQUE IP55

Doppia porta trasparente

Double transparent door

Double porte transparente



COD.	MODELLO / MODEL	+ZOCICOLO +PLINTH		
		H mm	L mm	W mm
108.87	<b>BOX1500PT</b>	1400	800	400
108.89	<b>BOX1700PT</b>	1600	800	400
108.91	<b>BOX1900PT</b>	1800	800	400
108.94	<b>BOX2100PT</b>	2000	800	400

# ACCESSORI

Accessori  
Accessories  
Accessoires

## TRASDUTTORE DI PRESSIONE IP65 IP65 PRESSURE TRANSDUCER TRANSDUCTEUR DE PRESSION IP65



COD.	MODELLO / MODEL	TIPO TYPE	CAMPO RANGE	ATTACCO THREAD
			bar	
101.271	<b>SPE10B1</b>	Danfoss DST P140	0÷10	¼"
101.281	<b>SPE16B1</b>	Danfoss DST P140	0÷16	¼"
101.291	<b>SPE25B1</b>	Danfoss DST P140	0÷25	¼"
101.301	<b>SPE40B1</b>	Danfoss DST P140	0÷40	¼"

COD.	MODELLO / MODEL	TIPO TYPE	CAMPO RANGE	ATTACCO THREAD
			bar	
112.11	<b>SPE/10B-3000</b>	Danfoss MSB 3000	0÷10	¼"
112.12	<b>SPE/16B-3000</b>	Danfoss MSB 3000	0÷16	¼"
112.13	<b>SPE/25B-3000</b>	Danfoss MSB 3000	0÷25	¼"
112.14	<b>SPE/40B-3000</b>	Danfoss MSB 3000	0÷40	¼"

## TRASMETTITORE DI LIVELLO IP68 IP68 LEVEL CAPACITOR ÉMETTEUR DE NIVEAU IP68



COD.	MODELLO / MODEL	ALIMENTAZIONE POWER	CAMPO RANGE
		v	bar
108.82	<b>TL-10</b>	12	0÷10

## TRASMETTITORE DI LIVELLO IP68 IP68 LEVEL CAPACITOR ÉMETTEUR DE NIVEAU IP68



COD.	MODELLO / MODEL	ALIMENTAZIONE POWER	CAMPO RANGE
		v	bar
108.83	<b>TLR-10</b>	12	0÷10

## PRESSOSTATO PRESSURE SWITCH PRESSOSTAT



COD.	MODELLO / MODEL	CAMPO RANGE	DIFFERENZ. DIFFERENT.
		bar	bar
106.10	<b>PM/5</b>	1÷5	0,6÷2,3
106.11	<b>PM/12</b>	3÷12	1,5÷5
106.14	<b>KP36</b>	2÷14	0,7÷4

## GALLEGGIANTE FLOAT SWITCHES FLOTTEURS



COD.	MODELLO MODEL	CAVO CABLE		
		tipo type	Ø mm	mt
105.42	<b>GALL5N</b>	neoprene	0,74	5
105.43	<b>GALL 10N</b>	neoprene	0,74	10
105.44	<b>GALL 15N</b>	neoprene	0,74	15
105.49	<b>GALL 20N</b>	neoprene	0,74	20
105.407	<b>GALL 6MC-7</b>	neoprene	0,74	6
105.597	<b>GALL 10MC-7</b>	neoprene	0,74	10
105.577	<b>GALL 15MC-7</b>	neoprene	0,74	15
105.587	<b>GALL 20MC-7</b>	neoprene	0,74	20
105.38	<b>CONTRAPPESO / COUNTERWEIGHT / CONTREPOID</b>			

## KIT DISPLAY ESTERNO EXTERNAL DISPLAY KIT KIT ÉCRAN EXTÉRIEUR



COD.	MODELLO / MODEL
111.091	<b>TR/ADX</b>

## SCHEDE ELETTRONICHE DI RICAMBIO SPARE PARTS ELECTRONIC BOARDS CARTES ELECTRONIQUE DE RECHANGE



COD.	MODELLO MODEL
112.05	<b>FULL-APP 1 MONO</b>
112.06	<b>FULL-APP 1 TRI</b>
112.07	<b>FULL-APP 2 MONO</b>
112.08	<b>FULL-APP 2 TRI</b>
112.09	<b>FULL-APP 3 MONO</b>
112.10	<b>FULL-APP 3 TRI</b>
112.18	<b>iCONTROL 1 PER "-APP"</b>
112.19	<b>iCONTROL 2 PER "-APP"</b>
112.00	<b>DOMINO UP MONO</b>
112.01	<b>DOMINO UP TRI</b>
112.02	<b>DOMINO UP TRI 20</b>
105.18	<b>SIMPLEX UP MONO</b>
105.19	<b>SIMPLEX UP TRI</b>
112.03	<b>SIMPLEX UP TRI 20 HP</b>
105.83	<b>DUPLEX UP MONO</b>
105.84	<b>DUPLEX UP TRI</b>
112.04	<b>DUPLEX TRI 20 HP</b>
105.89	<b>SA1/SLA1</b>
105.97	<b>COMMANDER</b>
105.92	<b>EN-SLA 4/12</b>
105.95	<b>EN-QAD1-EN-QAST1-EN-QAVS1 EN12845</b>
105.96	<b>EN QAM1/EN12845</b>
105.87	<b>QAD1-QAST1-QAVS1 UNI9490</b>

# ACCESSORI | Accessori

Accessories  
Accessoires

## BASI PER GRUPPI PRESSURIZZAZIONE BASES FOR BOOSTER SETS BASES POUR GROUPES DE PRESSION

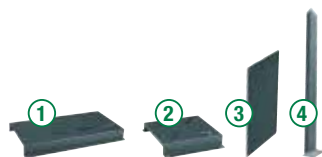

COD.	MODELLO MODEL	MISURE MEASURES		
		A mm	B mm	C mm
030.10	<b>BASE 01</b>	50	520	245
030.11	<b>BASE 02</b>	60	615	320
030.12	<b>BASE 03</b>	60	700	500
030.13	<b>BASE 04</b>	50	280	245
030.14	<b>ASTA 01</b>	40	-	480
030.17	<b>ASTA 02</b>	60	-	630
030.15	<b>PIASTRA 01</b>	-	190	270
030.16	<b>PIASTRA 02</b>	-	310	370

## COLLETTORI | Zincati

MANIFOLDS | Zinc plated  
COLLECTEUR | Acier galvanisé



COD.	MODELLO / MODEL	DNM	DNP
		in	in
106.83	<b>MAN 01</b>	1" ½	1"
106.84	<b>MAN 02</b>	2"	1" ¼
106.85	<b>MAN 03</b>	2" ½	1" ¼
106.86	<b>MAN 04</b>	2"	1" ¼
106.89*	<b>MAN 05*</b>	3"	1" ½
106.79	<b>MAN 06</b>	2" ½	1" ½
106.80	<b>ASP 01</b>	1" ½	1"
106.81	<b>ASP 02</b>	2"	1" ¼
106.82	<b>ASP 03</b>	2" ½	1" ½
106.87	<b>ASP 04</b>	3"	2"
106.88*	<b>ASP 05*</b>	4"	2"

\* modello flangiato / flanged model / modèle à bride

## COLLETTORI | Acciaio inox

MANIFOLDS | Stainless steel  
COLLECTEUR | Acier inoxydable



COD.	MODELLO / MODEL	DNM	DNP
		in	in
106.94	<b>MAN 011</b>	1" ½	1"
106.95	<b>MAN 021</b>	2"	1" ¼
106.96	<b>MAN 031</b>	2" ½	1" ½
106.97	<b>MAN 041</b>	3"	2"
106.90	<b>ASP 011</b>	2"	1" ¼
106.91	<b>ASP 021</b>	2" ½	1" ½
106.93	<b>ASP 031</b>	3"	2"

COD.	MODELLO MODEL	CARATTERISTICHE FEATURES
100.33	<b>POT/1</b>	Kit potenziometro per frequenza inverter Frequency converter potentiometer kit Kit potentiomètre pour convertisseur de fréquence
100.34	<b>SET-P/2</b>	Contatto pulito gestione 2 set point Volt free contact for 2 set points Contact sec gestion de 2 points de consigne
100.35	<b>ROT2P-5,5</b>	Kit rotazione inverter priorità motore fino a 5,5 Hp Motor priority inverter rotation kit up to 5,5 Hp Kit rotation inverter priorité moteur jusqu'à 5,5 Hp
100.36	<b>ROT2P-10</b>	Kit rotazione inverter priorità motore fino a 10 Hp Motor priority inverter rotation kit up to 10 Hp Kit rotation inverter priorité moteur jusqu'à 10 Hp
100.37	<b>ROT2P-15</b>	Kit rotazione inverter priorità motore fino a 15 Hp Motor priority inverter rotation kit up to 15 Hp Kit rotation inverter priorité moteur jusqu'à 15 Hp
100.38	<b>ROT3P-5,5</b>	Kit rotazione inverter priorità motore fino a 5,5 Hp Motor priority inverter rotation kit up to 5,5 Hp Kit rotation inverter priorité moteur jusqu'à 5,5 Hp
100.39	<b>ROT3P-10</b>	Kit rotazione inverter priorità motore fino a 10 Hp Motor priority inverter rotation kit up to 10 Hp Kit rotation inverter priorité moteur jusqu'à 10 Hp
100.40	<b>ROT3P-15</b>	Kit rotazione inverter priorità motore fino a 15 Hp Motor priority inverter rotation kit up to 15 Hp Kit rotation inverter priorité moteur jusqu'à 15 Hp
100.41	<b>BY-PASS-7,5</b>	Kit by pass avaria inverter fino a 7,5 HP Inverter fault bypass kit up to 7,5 Hp Kit de dérivation défaut. convertisseur jusqu'à 7,5 Hp
100.42	<b>BY-PASS-15</b>	Kit by pass avaria inverter fino a 15 HP Inverter fault bypass kit up to 15 Hp Kit de dérivation défaut. convertisseur jusqu'à 15 Hp
100.43	<b>BY-PASS-25</b>	Kit by pass avaria inverter fino a 25 HP Inverter fault bypass kit up to 25 Hp Kit de dérivation défaut. convertisseur jusqu'à 25 Hp
100.44	<b>BY-PASS-40</b>	Kit by pass avaria inverter fino a 40 HP Inverter fault bypass kit up to 40 Hp Kit de dérivation défaut. convertisseur jusqu'à 40 Hp
100.45	<b>BY-PASS-75</b>	Kit by pass avaria inverter fino a 75 HP Inverter fault bypass kit up to 75 Hp Kit de dérivation défaut. convertisseur jusqu'à 75 Hp

## CONDIZIONI DI VENDITA

Tutte le forniture effettuate da FOURGROUP sas (Venditore) saranno esclusivamente regolate dalle seguenti Condizioni Generali di Vendita.

Qualsiasi clausola o condizione stabilita dall'Acquirente è nulla e priva di effetti quando sia in contrasto con le condizioni sottoriportate.

### 1. Preventivi, ordine e conferma d'ordine

1.1. Il Preventivo eventualmente inviato FOURGROUP sas, recante, tra l'altro, la descrizione, le caratteristiche tecniche ed i prezzi della merce, non costituisce, in alcun caso, una proposta contrattuale di vendita, bensì un mero invito a proporre l'ordine.

Le condizioni presenti in detto preventivo sono destinate a perdere ogni validità ed efficacia trascorso il termine di validità indicato negli stessi, salvo che entro il predetto termine FOURGROUP sas non riceva l'Ordine dal Cliente medesimo.

1.2. L'Ordine del Compratore deve necessariamente contenere l'indicazione delle quantità e le designazioni dei prodotti richiesti. Ordini effettuati verbalmente o telefonicamente dovranno essere confermati dall'Acquirente per iscritto; in caso contrario FOURGROUP sas declina qualsivoglia responsabilità per errori nell'evasione dell'ordine.

1.3. Il semplice invio dell'Ordine da parte del Compratore implicherà, per ciò solo, l'integrale presa visione e la conoscenza da parte del Compratore stesso di tutte le presenti Condizioni Generali di Vendita, le quali, per tanto, dovranno così intendersi integralmente accettate senza limitazioni e riserve dai Contraenti.

1.4. Ogni Ordine dell'Acquirente diviene vincolante per FOURGROUP sas unicamente quando quest'ultima invierà la Conferma d'Ordine al Compratore. L'Acquirente accetterà integralmente le presenti Condizioni Generali di Vendita, la quantità dei prodotti ed il relativo prezzo trascorsi due giorni dal ricevimento della Conferma d'Ordine anche se non la rispetdisce timbrata e controfirmata a FOURGROUP sas.

1.5. Le indicazioni riportate su cataloghi, prospetti e listini non impegnano FOURGROUP sas, che si riserva la facoltà di apportare qualsiasi modifica ai propri prodotti e ai prezzi relativi; per tanto, FOURGROUP sas si considera vincolata esclusivamente da quanto riportato sulla sua Conferma d'Ordine.

1.6. Nella stesura dei cataloghi di FOURGROUP sas è stata dedicata la massima attenzione al fine di assicurare l'accuratezza dei dati; per altro, FOURGROUP sas non è responsabile per eventuali errori od omissioni ivi riscontrati, risultando vincolante ed impegnativo per le Parti unicamente quanto riportato nell'Ordine, nella Conferma d'Ordine e nelle presenti Condizioni Generali di Vendita.

### 2. Conclusione del contratto

2.1. Il contratto di compravendita si considera concluso solo con l'espressa accettazione da parte di FOURGROUP sas, attraverso l'emissione della Conferma d'Ordine.

### 3. Prezzi

3.1. I prezzi contrattuali sono quelli riportati sulla Conferma d'Ordine e si intendono per merce resa franco fabbrica, per quanto riguarda le vendite internazionali Ex Works (ovvero EXW), in base agli Incoterms (International Commerce Terms).

3.2. Qualsiasi modifica al contratto, richiesta successivamente alla sua conclusione dall'Acquirente, non avrà valore ed efficacia se non accettata per iscritto da FOURGROUP sas, con l'eventuale precisazione dei nuovi termini di consegna, del prezzo e delle modalità di pagamento.

### 4. Termini di consegna

4.1. I termini di consegna riportati sulla Conferma d'Ordine sono indicativi, salvo l'impegno di FOURGROUP sas ove possibile, di osservarli.

4.2. Resta inteso che, stante la natura indicativa dei termini di consegna, FOURGROUP sas in nessun caso potrà essere ritenuta responsabile dei danni, anche indiretti, che dovessero derivare al Compratore da ritardi nella consegna, salvo che la data di consegna sia stata garantita da FOURGROUP sas per iscritto accettando un accordo con penali giornaliera in caso di ritardi.

4.3. Resta, per altro, in facoltà di FOURGROUP sas di prorogare il termine di consegna ovvero di sospendere la consegna del materiale oggetto del contratto, ad insindacabile discrezione del Venditore medesimo:

- quando il Compratore non rispetti le condizioni di pagamento convenute ovvero ritardi l'adempimento di propri obblighi contrattuali (come, a titolo solo esemplificativo, l'invio di quote anticipate, la costituzione di garanzie, l'emissione e la consegna di titoli di credito, nonché altri adempimenti finanziari), anche relativi a precedenti rapporti con FOURGROUP sas;
- in caso di forza maggiore o di eventi quali, a titolo solo esemplificativo: serratte, scioperi, totali o parziali, astensioni dal lavoro, epidemia, guerra, incendio, inondazione, incidenti di lavorazione, interruzioni o ritardi nei trasporti, mancanza od insufficienza di energia motrice e, comunque, in presenza di ogni altro evento non dipendente da causa imputabile FOURGROUP sas o ai suoi Fornitori;
- quando il Compratore non fornisca in tempo utile i dati necessari alla esecuzione della fornitura e/o i materiali che si è riservato di fornire FOURGROUP sas;
- quando siano intervenute modifiche nell'Ordine, quantunque accettate FOURGROUP sas;
- in caso di difficoltà nell'approvvigionamento di materie prime.

Nei casi in cui la sospensione della fornitura ovvero la proroga dei termini di consegna sia dipesa da cause, a qualunque titolo, riferibili all'Acquirente (così, a titolo esemplificativo, nelle ipotesi riportate al precedente capoverso sub lett. a, c, d), FOURGROUP sas avrà diritto di conseguire dal Compratore medesimo il risarcimento dei danni patiti.

4.4. Eventuali ritardi nelle consegne non daranno, comunque, diritto al risarcimento dei danni a favore del Compratore.

### 5. Sospensioni o annullamenti degli ordini

5.1. In caso di sospensione o di annullamento dell'Ordine da parte del Compratore, FOURGROUP sas potrà reclamare:

- il costo delle lavorazioni e dei materiali calcolato pro-rata in relazione all'avanzamento dell'ordine; la merce rimarrà a disposizione del Compratore;
- i maggiori oneri derivanti per FOURGROUP sas dall'inadempimento del Compratore, oltre al 20% della differenza tra l'ammontare dell'ordine e la cifra precedente riferita al punto a).

### 6. Consegne

6.1. La consegna si intende, di regola, stabilita ex-works (EXW) presso gli stabilimenti FOURGROUP sas.

6.2. In particolare, la consegna si intende eseguita, ad ogni effetto di legge, con la comunicazione (data anche con il semplice invio d.d.t.) che la merce è a disposizione dell'Acquirente per il ritiro, oppure che la stessa è stata consegnata al vettore.

6.3. Una volta ricevuta la comunicazione di merce pronta, l'Acquirente dovrà indicare tempestivamente il nominativo del vettore, se da lui incaricato, che provvederà al ritiro; il Compratore dovrà altresì provvedere alle coperture assicurative per il trasporto.

6.4. In caso di ritardo nel ritiro della merce, comunque approntata, per una qualsiasi ragione non dipendente dalla volontà di FOURGROUP sas, la consegna si intenderà comunque come eseguita dalla comunicazione di messa a disposizione, con le conseguenze di seguito riportate:

- FOURGROUP sas avrà il diritto di procedere alla fatturazione e di reclamare l'adempimento delle condizioni di pagamento pattuite;
- FOURGROUP sas potrà fare effettuare l'imballaggio, il trasporto o lo stoccaggio del materiale a spese del Compratore, salvo il risarcimento dei danni eventualmente patiti, anche per l'immagazzinamento, la custodia ed il deposito della merce.

### 7. Pagamenti

7.1. I pagamenti devono essere effettuati al domicilio del Venditore e secondo le condizioni concordate. Qualsiasi pagamento effettuato in luogo e modo diversi, non sarà ritenuto valido e, dunque, non produrrà effetti liberatori per l'Acquirente.

7.2. In caso di ritardo nei pagamenti alle scadenze convenute, il Venditore avrà diritto di addebitare gli interessi di mora ai sensi del decreto legislativo 9 ottobre 2002 n. 231.

7.3. Qualsiasi reclamo o contestazione non darà diritto all'Acquirente di sospendere o ritardare i pagamenti.

7.4. Il rilascio di cambiali, pagherò, tratte, assegni o qualsiasi altra forma di pagamento o mezzo di garanzia, non comporterà variazione del contratto né di alcuna delle clausole contrattuali (in particolare, non modificherà il foro competente in caso di controversia) e dovrà considerarsi esclusivamente come inteso a facilitare la definizione del rapporto, senza alcun effetto novativo.

7.5. Gli eventuali anticipi percepiti dal Venditore sono sempre infruttiferi di interessi.

### 8. Spedizioni

8.1. Tutte le operazioni di trasporto, assicurazione, dogana, dazio, movimentazione e consegna, sono a carico, spese, rischio e pericolo del Compratore al quale compete l'onere di verificare le spedizioni all'arrivo e di esercitare, se del caso, le eventuali lamentele nei confronti del vettore, anche se la spedizione è stata eseguita in porto franco.

8.2. In caso di spedizione con mezzi di FOURGROUP sas, questa è fatta in porto assegnato al meglio e sotto la piena responsabilità dell'Acquirente.

### 9. Reclami

9.1. Eventuali reclami o contestazioni da parte del Compratore sul prodotto fornito dovranno essere segnalati a FOURGROUP sas, a pena di decadenza, entro 8 giorni dalla data della consegna e dovranno essere effettuati per iscritto.

9.2. I reclami per eventuali manomissioni od ammanchi dovranno essere perentoriamente segnalati, per iscritto, dal Compratore al Vettore, al momento del ricevimento della merce.

### 10. Garanzia

10.1. FOURGROUP sas garantisce che i propri prodotti ed i loro componenti sono esenti da difetti di fabbricazione per una durata di 12 mesi a decorrere dalla data della consegna della merce; tale durata potrà essere estesa, fino ad un massimo di 18 mesi, qualora la merce abbia stazionato presso i magazzini di nostri rivenditori.

10.2. La garanzia è limitata alla riparazione o sostituzione, ad insindacabile scelta di FOURGROUP sas, franco deposito indicato dal Venditore stesso, dei pezzi difettosi per accertato difetto di materiale o di lavorazione. Le parti sostituite restano di proprietà di FOURGROUP sas.

10.3. La garanzia non copre materiali e parti soggette a naturale usura o deterioramento (quali, a puro titolo esemplificativo, fusibili, guarnizioni, candele, filtri, spie luminose).

10.4. Ogni sorta di indennizzo è escluso, né potranno essere reclamati danni, diretti ed indiretti (anche nei confronti di terzi), di qualsiasi natura e specie anche per il temporaneo non uso dei prodotti acquistati. L'esame dei difetti e delle loro cause sarà sempre effettuato da FOURGROUP sas, presso i suoi stabilimenti.

10.5. Le spese (come, per esempio, la manodopera, lo smontaggio, il rimontaggio, il trasporto, il vitto e l'alloggio) per intervento esterno di personale FOURGROUP sas, anche in caso di riconosciuta garanzia, sono sempre a carico del Compratore.

Restano a carico di FOURGROUP sas il costo dei pezzi sostituiti e quello inerente al tempo necessario alla sostituzione degli stessi.

10.6. Sono esclusi dalla garanzia i prodotti conservati, installati, impiegati o mantenuti in modo negligente o errato ovvero non conforme alle indicazioni del Venditore o comunque modificati, riparati o smontati anche in parte.

10.7. La garanzia è pure esclusa per danni e/o difetti e/o anomalie derivanti da eventi o componenti esterni (come, a titolo esemplificativo: scariche atmosferiche, fulmini, sovradimensionamento dei carichi, errato montaggio dei carichi, ecc.).

10.8. La garanzia di cui al presente articolo 10 sostituisce ed esclude ogni altra forma di garanzia, anche legale.

10.9. Il Compratore decade dalla garanzia di cui al presente articolo nel caso in cui venga meno ad uno qualsiasi degli obblighi contrattuali assunti, in particolare con riguardo alle condizioni di pagamento.

10.10. Le eventuali riparazioni in garanzia dovranno essere richieste per iscritto dall'Acquirente a FOURGROUP sas, indicando il numero di serie dell'apparecchiatura o macchina, difetto lamentato, riferimenti del documento di acquisto.

10.11. Per le parti sostituite o riparate, ed unicamente per esse, il periodo di garanzia ha nuovamente inizio e decade lo stesso giorno della scadenza della garanzia della macchina o dell'apparecchiatura elettrica.

### 11. Responsabilità

11.1. In caso di responsabilità di FOURGROUP sas per prodotti difettosi, il risarcimento non potrà eccedere l'importo del prezzo d'acquisto degli stessi prodotti difettosi.

11.2. In ogni caso, FOURGROUP sas non dovrà rispondere dei danni indiretti, quali, per esempio, la perdita di clientela, di fatturato, di produzione, di profitto, di immagine, oltre che dei danni derivanti all'Acquirente dalle azioni eventualmente intraprese nei confronti di quest'ultimo da terzi.

11.3. E', comunque, esclusa ogni responsabilità del Venditore qualora i difetti del prodotto siano dovuti, a titolo meramente esemplificativo, a:

- utilizzo non corretto, anomalo o smodato;
- manutenzione impropria, scorretta o manchevole;
- impiego del prodotto non abituale o contrario alle avvertenze del Venditore o, comunque, diverso da quello cui è destinato;
- utilizzo del prodotto con altri componenti;
- conservazione inadatta.

### 12. Legge regolatrice, giurisdizione e Foro competente

12.1. Per ogni controversia relativa alla stipulazione, validità, interpretazione, esecuzione e cessazione del presente contratto, la legge regolatrice sarà unicamente quella italiana, con giurisdizione esclusiva del giudice italiano e competenza esclusiva del Foro di Padova, con espressa esclusione di ogni altro e diverso Foro alternativo.

### 13. Riserva di proprietà dei beni. Indennità

13.1. Il trasferimento della proprietà dei beni oggetto della presente Vendita non avverrà che dopo l'integrale pagamento del prezzo convenuto, ai sensi degli artt.1523 e ss. del Codice Civile.

13.2. Il mancato pagamento nei termini stabiliti anche di una sola rata che superi l'ottava parte del prezzo di vendita ovvero il mancato pagamento di due rate, indipendentemente dal loro ammontare, secondo le modalità convenute, determinerà automaticamente la decadenza dell'Acquirente dal beneficio del termine, con conseguente diritto di FOURGROUP sas di reclamare l'integrale ed immediato pagamento, in un'unica soluzione, dell'intero proprio credito residuo.

13.3. Per altro, ove il Venditore lo preferisca, sarà sua facoltà di ritenere risolto di diritto il contratto e, per l'effetto, ottenere l'immediata restituzione del materiale consegnato, trattenere, a titolo di indennità, tutte le rate riscosse, nonché esigere il pagamento delle rate scadute e dei 3/5 (tre quinti) di quelle ancora da scadere, salvo il risarcimento dei maggiori danni.

### 14. Forma convenzionale

14.1. Il presente contratto costituisce la sola fonte negoziale di regolamento dei rapporti tra le Parti.

14.2. Tutte le convenzioni dirette a derogare, modificare e/o integrare, anche solo in parte, le presenti Condizioni Generali di Vendita dovranno essere stipulate e provate per iscritto.

14.3. Il Compratore dà atto di avere ricevuto e di avere attentamente visionato la documentazione tecnica fornita dal Venditore inerente al materiale acquistato.

### 15. Clausole nulle

15.1. L'eventuale nullità di una o più disposizioni del presente contratto non incide, per espressa e concordata volontà delle Parti, sulla validità del contratto nel suo complesso.



# SALES GENERAL CONDITIONS

All sales entered into by FOURGROUP sas (the Vendor) are to be governed exclusively by the following Sales General Conditions.

Any clause or condition drawn up by the Buyer shall become null and void if found to be in conflict with the following conditions.

## 1. Quotes, orders and order confirmation

- 1.1. Estimates issued by FOURGROUP sas, including the description, technical features and prices of the goods shall not in any case be considered as a binding sales agreement, but rather a quote. The conditions set forth in said quote shall lose all validity and effect thirty days from the time they are transmitted to the Customer, unless FOURGROUP sas receives an Order from the Customer in the meantime.
- 1.2. The Buyer's Order must include indication of the quantity and name of the products required. Unwritten orders (required by phone or verbally) have to be confirmed with a written reply by the buyer; otherwise FOURGROUP sas doesn't take charge of any kind of mistakes about orders proceeding.
- 1.3. The mere sending of the Order by the Buyer shall imply that the Buyer has read and is familiar with all these General Conditions of Sale, which shall consequently be fully accepted unconditionally and without restriction by the Parties.
- 1.4. Buyer's Orders only become binding for the FOURGROUP sas after the latter has sent an Order Confirmation to the Buyer. The Buyer will totally accept these General Condition of Sales, products quantity and prices, once two days have elapsed from the receiving of order confirmation even if the buyer doesn't send the same order confirmation stamped and countersigned to FOURGROUP sas
- 1.5. Information provided in catalogues, schedules and price-lists is not binding for FOURGROUP sas, which reserves the right to make any modification whatever to its products and to prices thereof in view of which, the FOURGROUP sas is to be considered bound only by such details as appear in the relative Order Confirmation.
- 1.6. FOURGROUP sas's catalogues have been drawn up with the utmost attention in order to ensure the accuracy of information, however, FOURGROUP sas declines responsibility for any errors or omissions contained in the same, as the Parties are only bound by the contents of Orders, Order Confirmation and these General Conditions of Sale.

## 2. Conclusion of the contract

- 2.1. The contract of sale shall only be considered as concluded with FOURGROUP sas's explicit acceptance thereof by means of the Order Confirmation issued by FOURGROUP sas.

## 3. Prices

- 3.1. The contract prices are those set forth in the Order Confirmation, and are to be considered as being for merchandise made ready by FOURGROUP sas "ex-works" (EXW), according to Incoterms (International Commerce Terms).
- 3.2. Any amendment to the contract requested by the Buyer after its conclusion shall be null and void unless accepted in writing by FOURGROUP sas, specifying new terms of delivery, prices and terms of payment where applicable.

## 4. Delivery dates

- 4.1. The terms of delivery stated on the Order Confirmation are indicative, without prejudice to FOURGROUP sas's undertaking to observe the same as far as possible.
- 4.2. In any event, given the indicative nature of the terms of delivery, FOURGROUP sas shall in no circumstances be held responsible for any direct or indirect damage to the Buyer on account of late delivery, unless shipment date has been guaranteed in a written way by FOURGROUP sas accepting an agreement with daily penalty clauses in case of delay.
- 4.3. FOURGROUP sas is entitled to postpone the delivery deadline or suspend the delivery of the contractual material, at its unchallengeable discretion:
  - a) should the Buyer fail to observe the conditions of payment established or be late in fulfilling its contractual obligations (such as, by way of a non-limiting example, the sending of advances, granting of guarantees, issue and presentation of credit instruments and other financial fulfillments) including those relating to previous relations with FOURGROUP sas;
  - b) force majeure and like instances, such as, by way of a non-limiting example strikes, lock-outs or abstention from labour, epidemic, war, requisition, fire, flood, processing incidents and stoppages and/or delays in transportation, blackout or inadequacy of power supplies and any other event that cannot be attributed to FOURGROUP sas or its suppliers;
  - c) failure on the part of the Buyer to provide FOURGROUP sas, in good time, with any information it has undertaken to provide and necessary for the supply and/or materials to be delivered.
  - d) when amendments are made to the Order, even with FOURGROUP sas's acceptance;
  - e) in the event of difficulties in procurement of raw materials.
- In cases in which suspension of supplies or extension in delivery deadlines are due to causes that can be referred in any way to the Buyer (such as, by way of a non limiting example, those cases set forth in the previous paragraph under points a, c and d), FOURGROUP sas shall be entitled to claim compensation from the Buyer for the damage suffered.
- 4.4 Delayed delivery shall not in any case entitle the Buyer to claim for compensation for damage.

## 5. Suspended or cancelled orders

- 5.1. In the event of the Buyer's suspending or cancelling an order, FOURGROUP sas reserves the right to invoice the Buyer in respect of:
  - a) the cost, calculated pro-rata, of materials utilized and of work accomplished in filling the order thus far. The merchandise in this instance remaining at the Buyer's disposal;
  - b) increased expenditure ensuing to FOURGROUP sas from the Buyer's failure to settle, in addition to 20% of the difference between the order sum-total and the amount previously arrived at by the application of point a).

## 6. Deliveries

- 6.1. Delivery is usually understood as ex-works (EXW) at FOURGROUP sas's premise.
- 6.2. Specifically, delivery may be said to have taken place, to all intents and purposes, with the sending of notice (which may simply take the form of an invoice) either to the effect that merchandise is available for collection by the Buyer, or to the effect that it has been handed over to the freight company.
- 6.3. Once notice has been received that the goods are ready, the Buyer must swiftly indicate the name of the freight company, when appointed by the same, which will collect the goods. The Buyer must also arrange insurance cover for transportation.
- 6.4. In case of the late collection of merchandise made ready by FOURGROUP sas for any reason whatsoever not attributable to lack of goodwill on the part of FOURGROUP sas, the goods shall be considered delivered starting from the communication that the goods were ready for collection, with the following consequences:
  - a) FOURGROUP sas shall be entitled to issue the relative invoice and claim fulfillment of the terms of payment established;
  - b) FOURGROUP sas may package, transport or store the material at the Buyer's expense, without prejudice to its right to claim for any damage suffered, including the costs for warehousing, keeping and storage of the goods.

## 7. Payment

- 7.1. Payments must be remitted to FOURGROUP sas's place of business, and made in accordance with such conditions as are agreed; any remittance made at location or in manner differing therefrom, may not be deemed valid and shall consequently not have a redeeming effect for the Buyer
- 7.2 In the event of late payment at the agreed deadlines, FOURGROUP sas shall be entitled to charge penalty interest pursuant to Legislative Decree no. 231 of 9th October 2002.
- 7.3. Any claims or disputes give no right to the Buyer to suspend or delay the payment of invoices.
- 7.4. The issue of bills of exchange, IOUs, drafts, cheques or any other form of payment or guarantee shall not cause any amendment to the contract or any of the contract clauses (specifically, it shall not change the place of jurisdiction in the case of a dispute) and shall be exclusively considered as aimed at facilitating the definition of the relationship, without having any novation effect.

- 7.5. Advance payment to FOURGROUP sas shall always be non-interest bearing.

## 8. Freightforwarding

- 8.1. All transactions regarding transport, insurance, customs and excise, handling, and delivery are at the care, expense and risk of the Buyer, whose responsibility it is both to check the merchandise upon arrival and to make any claim against the freight company by direct approach, even where merchandise has been dispatched carriage-paid.
- 8.2. In those cases where FOURGROUP sas's transport facilities are utilized for shipping merchandise, the latter is to be dispatched, ex-works at best, with the Buyer duly assuming total responsibility thereof.

## 9. Claims

- 9.1. Any claim or contestation on the part of the Buyer with regard to merchandise supplied, must be forwarded in writing to FOURGROUP sas within 8 working days of the date of delivery of the goods and sent to FOURGROUP sas
- 9.2. In the event of claims for tampering with or shortage of goods, the Buyer shall promptly notify the freight company in writing at the time the goods are received.

## 10. Warranty

- 10.1. FOURGROUP sas guarantees the good operation of the standard FOURGROUP sas products for 12 months from the date of their dispatch. This warranty period could be extended and become 18 months if the goods have stand in our retailer's warehouses.
- 10.2. The warranty is limited to repair or replacement of parts at FOURGROUP sas's unchallengeable discretion, forwarded carriage-paid to an address specified FOURGROUP sas, which show recognizable defects due to defective materials or manufacturing. The parts replaced remain property of FOURGROUP sas.
- 10.3. The warranty does not cover parts that are subject to natural wear or deterioration (such as, by way of a non-limiting example, seal rings, fuse, filters, warning light).
- 10.4. No other compensation of any kind is envisaged by the warranty, neither can there be any question of claims for damages of any kind, direct or indirect, (including by third parties), even in respect of temporarily suspended use of the merchandise purchased. Examination of such defects and the causes thereof is to be carried out at one of FOURGROUP sas's factories, by FOURGROUP sas.
- 10.5 Expenses relating to operations (such as, for example, labour, dismantling, reassembly, transport, board and lodgings) by FOURGROUP sas's personnel to outside locations for the purpose, are chargeable to the Buyer, even in case the right to repairs under warranty has been acknowledged. FOURGROUP sas will be chargeable only for the costs of replaced parts and the time needed to replace them.
- 10.6. The warranty ceases to be effective for products stored, installed utilized or maintained in a negligent or improper manner, i.e. not in accordance to FOURGROUP sas's instructions, or modified and/or repaired in any way whatsoever, or entirely or partially disassembled
- 10.7. The warranty also excludes damages and/or defects and/or abnormalities deriving from external components (such as, by way of a non-limiting example lightnings, atmospheric discharge etc.).
- 10.8. The warranty mentioned in article 10 replaces and excludes any other form of warranty, even legal.
- 10.9. The Buyer's entitlement to the warranty mentioned in this article shall be null and void in the case of non-performance of even just one of the contractual obligations assumed, specifically as regards the conditions of payment.
- 10.10. Any repairs under warranty and/or not under warranty are to be required in writing by the Buyer to FOURGROUP sas, writing the serial number of the product, defect claimed, mentioning purchasing document.
- 10.11. For replaced or repaired parts and for these alone, the warranty period recommences and void the same day of the expiry date of the warranty of the product or of electrical equipment.

## 11. Liability

- 11.1. Should FOURGROUP sas be liable for faulty products, the compensation shall not in any case exceed the purchase price of the same faulty products.
- 11.2. FOURGROUP sas shall not in any case be liable for indirect damage such as, for example, loss of clientele, turnover, production, profit, image or any damage to the Buyer for any action taken against it by third parties.
- 11.3. FOURGROUP sas shall not in any case be liable when product defects are due, by way of a non-limiting example, to:
  - a) improper, incorrect or excessive use;
  - b) improper, incorrect or inadequate maintenance
  - c) product use that is unusual or contrary to FOURGROUP sas's warnings or, in any case, different to its intended use;
  - d) use of product with non-original components;
  - e) improper conservation

## 12. Applicable law, jurisdiction and place of jurisdiction

- 12.1. Any dispute concerning the stipulation, validity, interpretation, execution and termination of this agreement shall be governed by Italian Law and the court of Padova shall have sole jurisdiction, with the exclusive jurisdiction of the Italian judge, with the explicit exclusion of any other court.

## 13. Proprietorship of goods. Indemnity

- 13.1. The property of the goods forming the subject of this sale is of FOURGROUP sas and shall be transferred to the Buyer only upon full payment of the agreed price by the Buyer pursuant to articles 1523 f. of the Italian Civil Code.
- 13.2. Non-payment within the established terms of even just one instalment amounting to over one eighth of the sale price or non-payment of two instalments regardless of the sum of the same, according to the agreed terms, shall automatically invalidate the Buyers' acceleration clause, with FOURGROUP sas consequently being entitled to full and immediate payment, in a single settlement of the full residual credit.
- 13.3. Furthermore, when preferred by FOURGROUP sas, it shall be entitled to terminate the agreement and consequently obtain immediate return of the material delivered, withhold as indemnity, all the installments paid and demand payment of the instalments expired and 3/5 (three fifths) of those yet to expire, without prejudice to compensation for further damage.



























## 14. Form of the agreement















- 14.1. This agreement represents the only negotiation instrument governing relations between the Parties.
- 14.2. Any agreements to derogate, amend and/or supplement these General Conditions of Sale shall be stipulated and proven in writing.
- 14.3. The Buyer hereby agrees to have received and carefully examined the technical documentation provided by FOURGROUP sas, drawn up in Italian and English, regarding the material acquired.

## 15. Invalid clauses

- 15.1. The Parties hereby explicitly agree that the invalidity of one or more provisions of this agreement shall not affect the validity of the agreement as a whole.

INDICE / INDEX / INDEX

	<b>SERIE STAR</b> STAR SERIES / SÉRIE STAR	PAG. 10
	<b>SERIE STAR-2</b> STAR-2 SERIES / SÉRIE STAR-2	PAG. 12
	<b>SERIE STAR-D</b> STAR-D SERIES / SÉRIE STAR-D	PAG. 14
	<b>SERIE STAR-2D</b> STAR-2D SERIES / SÉRIE STAR-2D	PAG. 16
	<b>SERIE FULLAPP</b> FULLAPP SERIES / SÉRIE FULLAPP	PAG. 20
	<b>SERIE SIMPLEX-UP</b> SIMPLEX-UP SERIES / SÉRIE SIMPLEX-UP	PAG. 24
	<b>SERIE DUPLEX-UP</b> DUPLEX-UP SERIES / SÉRIE DUPLEX-UP	PAG. 26
	<b>SERIE DOMINO-UP</b> DOMINO-UP SERIES / SÉRIE DOMINO-UP	PAG. 28
	<b>SERIE RAIN</b> RAIN SERIES / SÉRIE RAIN	PAG. 30
	<b>SERIE DELTA APP</b> DELTA APP SERIES / SÉRIE DELTA APP	PAG. 34
	<b>SERIE STATOR APP</b> STATOR APP SERIES / SÉRIE STATOR APP	PAG. 36
	<b>SERIE SOFT APP</b> SOFT APP SERIES / SÉRIE SOFT APP	PAG. 38
	<b>SERIE INVERTER APP</b> INVERTER APP SERIES / SÉRIE INVERTER APP	PAG. 40
	<b>SERIE AMM AMMC ATT</b> AMM AMMC ATT SERIES / SÉRIE AMM AMMC ATT	PAG. 42
	<b>SERIE DEEP</b> DEEP SERIES / SÉRIE DEEP	PAG. 44
	<b>SERIE EDOL</b> EDOL SERIES / SÉRIE EDOL	PAG. 48
	<b>SERIE QAR-E</b> QAR-E SERIES / SÉRIE QAR-E	PAG. 52
	<b>SERIE DELTA</b> DELTA SERIES / SÉRIE DELTA	PAG. 56
	<b>SERIE STATOR</b> STATOR SERIES / SÉRIE STATOR	PAG. 60
	<b>SERIE AUTOTRASF</b> AUTOTRASF SERIES / SÉRIE AUTOTRASF	PAG. 62
	<b>SERIE ECOSOFT</b> ECOSOFT SERIES / SÉRIE ECOSOFT	PAG. 64
	<b>SERIE SOFT</b> SOFT SERIES / SÉRIE SOFT	PAG. 66
	<b>SERIE ECOEASY</b> ECOEASY SERIES / SÉRIE ECOEASY	PAG. 70
	<b>SERIE EASY INVERTER</b> EASY INVERTER SERIES / SÉRIE EASY INVERTER	PAG. 72
	<b>SERIE EASY INVERTER D</b> EASY INVERTER D SERIES / SÉRIE EASY INVERTER D	PAG. 76
	<b>SERIE EASY INVERTER D M/F</b> EASY INVERTER D M/F SERIES / SÉRIE EASY INVERTER D M/F	PAG. 78

	<b>SERIE VFD-C</b> VFD-C SERIES / SÉRIE VFD-C	PAG. 80
	<b>SERIE ALARM</b> ALARM SERIES / SÉRIE ALARM	PAG. 82
	<b>SERIE ALS</b> ALS SERIES / SÉRIE ALS	PAG. 84
	<b>SERIE SIMPLEX-UP</b> SIMPLEX-UP SERIES / SÉRIE SIMPLEX-UP	PAG. 86
	<b>SERIE EN-SLA 4/12</b> EN-SLA 4/12 SERIES / EN-SLA 4/12	PAG. 87
	<b>SERIE EN-QAD 1</b> EN-QAD 1 SERIES / SÉRIE EN-QAD 1	PAG. 88
	<b>SERIE EN-QAST 1</b> EN-QAST 1 SERIES / SÉRIE EN-QAST 1	PAG. 90
	<b>SERIE EN-QAVS 1</b> EN-QAVS 1 SERIES / SÉRIE EN-QAVS 1	PAG. 92
	<b>SERIE EN-QAM 1</b> EN-QAM 1 SERIES / SÉRIE EN-QAM 1	PAG. 94
	<b>SERIE SENTINEL</b> SENTINEL SERIES / SÉRIE SENTINEL	PAG. 96
	<b>SERIE QCM</b> QCM SERIES / SÉRIE QCM	PAG. 98
	<b>SERIE LP2000</b> LP2000 SERIES / SÉRIE LP2000	PAG. 99
	<b>SERIE SHUTTLE 4D</b> SHUTTLE 4D SERIES / SÉRIE SHUTTLE 4D	PAG. 99
	<b>ACCESSORI</b> ACCESSORIES / ACCESSOIRES	PAG. 100

LEGENDA / LEGEND / LÉGENDE

	display LCD LCD display écran ACL		contaore di funzionamento operating hour counter compteur de fonctionnement
	voltmetro voltmeter voltmètre		amperometro ammeter ampèremètre
	involucro in ABS ABS enclosure coffret en ABS		grado di protezione protection rating degré de protection
	temperatura ambientale ambient temperature température ambiante		umidità relativa (non condensata) relative humidity (condensate free) humidité relative (non condensée)
	galleggiante per acque chiare float for clean water flotteur pour eaux claires		galleggiante per acque reflue float for waste water flotteur pour eaux usées
	sonde di livello per acque chiare level probes for clean water sondes de niveau pour eaux claires		pressostato regolabile adjustable pressure switch pressostat réglable
	fattore di potenza power factor facteur de puissance		senore di pioggia rain sensor capteur de pluie
	sens. di livello a immersione 4÷20mA immersion level probe 4÷20mA capt.de niveau à immersion 4÷20mA		sens. di livello a immersione 4÷20mA immersion level probe 4÷20mA capt.de niveau à immersion 4÷20mA
	senore di pressione 4÷20mA pressure sensor 4÷20mA capteur de pression 4÷20mA		controllo di livello cablato wired level control contrôle de niveau câblé
	autoritenuta self-holding automaintien		galleggiante per acque chiare float for clean water flotteur pour eaux claires

## OPTIONALS

COD.	MODELLO / MODEL	CARATTERISTICHE / FEATURES		
100.46	<b>RGL/1</b>	Relè zoccolato per logica funzionamento	Logic operation relay	Relais avec socle pour logique de fonctionnement
100.47	<b>KIT/UEV24</b>	Kit elettrovalvola 24V	24V Solenoid valve kit	Kit électrovanne 24V
100.48	<b>KIT/MA2G</b>	Kit marcia arresto per 2 galleggianti	Start and stop kit for 2 float switches	Kit marche- arrêt pour 2 flotteurs
100.50	<b>SP/1</b>	Kit sensore pioggia	Rain sensor kit	Kit capteur de pluie
100.52	<b>CL-C</b>	Controllo di livello	Level control	Contrôle de niveau
100.54	<b>RA2P</b>	Relè alternanza pompe	Pump exchanger relay	Relais alternance pompes
100.57	<b>RUA/1</b>	Relè zoccolato con morsettiera per uscita allarme	Alarm output relay with terminal board	Relais avec socle avec bornier pour sortie d'alarme
100.58	<b>PMA</b>	Pulsante marcia arresto	Start and stop button	Bouton-poussoir marche-arrêt
101.271	<b>SPE/10B</b>	Sensore pressione 10 bar - 4-20mA - 12V	10 bar pressure transducer - 4-20mA - 12V	Capteur de pression 10 bars - 4-20mA - 12V
101.281	<b>SPE/16B</b>	Sensore pressione 16 bar - 4-20mA - 12V	16 bar pressure transducer - 4-20mA - 12V	Capteur de pression 16 bars - 4-20mA - 12V
101.291	<b>SPE/25B</b>	Sensore pressione 25 bar - 4-20mA - 12V	25 bar pressure transducer - 4-20mA - 12V	Capteur de pression 25 bars - 4-20mA - 12V
101.301	<b>SPE/40B</b>	Sensore pressione 40 bar - 4-20mA - 12V	40 bar pressure transducer - 4-20mA - 12V	Capteur de pression 40 bars - 4-20mA - 12V
112.11	<b>SPE/10B-3000</b>	Sensore pressione 10 bar - 4-20mA - 12V	10 bar pressure transducer - 4-20mA - 12V	Capteur de pression 10 bars - 4-20mA - 12V
112.12	<b>SPE/16B-3000</b>	Sensore pressione 16 bar - 4-20mA - 12V	16 bar pressure transducer - 4-20mA - 12V	Capteur de pression 16 bars - 4-20mA - 12V
112.13	<b>SPE/25B-3000</b>	Sensore pressione 25 bar - 4-20mA - 12V	25 bar pressure transducer - 4-20mA - 12V	Capteur de pression 25 bars - 4-20mA - 12V
112.14	<b>SPE/40B-3000</b>	Sensore pressione 40 bar - 4-20mA - 12V	40 bar pressure transducer - 4-20mA - 12V	Capteur de pression 40 bars - 4-20mA - 12V
108.82	<b>TL-10</b>	Trasduttore Livello piezoresistivo 4÷20mA	Piezoresistive level transducer 4÷20mA	Transducteur de niveau piézo-résistif 4÷20mA
108.83	<b>TLR-10</b>	"Trasduttore Livello piezoresistivo 4÷20mA	Piezoresistive level transducer 4÷20mA	Transducteur de niveau piézo-résistif 4÷20mA
101.90	<b>KITC/20 mF</b>	Kit condensatore cablato 20 mF	20 mF wired capacitor Kit	Kit condensateur câblé 20 mF
101.91	<b>KITC/30 mF</b>	Kit condensatore cablato 30 mF	30 mF wired capacitor Kit	Kit condensateur câblé 30 mF
101.92	<b>KITC/40 mF</b>	Kit condensatore cablato 40 mF	40 mF wired capacitor Kit	Kit condensateur câblé 40 mF
101.93	<b>KITC/50 mF</b>	Kit condensatore cablato 50 mF	50 mF wired capacitor Kit	Kit condensateur câblé 50 mF
101.94	<b>KITC/70 mF</b>	Kit condensatore cablato 70 mF	70 mF wired capacitor Kit	Kit condensateur câblé 70 mF
103.97	<b>PFE</b>	Pulsante fungo di emergenza	Mushroom head emergency button	Bouton coup-de-poing d'urgence
104.51	<b>CV3F</b>	Commutatore Voltmetrico	Voltmeter Selector	Commutateur voltométrique
104.61	<b>CA3F</b>	Commutatore Amperometrico	Ammeter Selector	Commutateur ampérométrique
112.17	<b>KIT GSM-E</b>	Modem GSM con batteria+antenna+cavo USB+CDrom	GSM Modem with battery+antenna+USB+CDRom	Modem GSM avec batterie+antenne+câble USB+Cdrom
105.50	<b>TG1/ext</b>	Timer giornaliero a cavalieri esterno quadro	Front Box daily Timer with switch rider	Programmateur journ. à cavaliers à l'extérieur du coffret
105.501	<b>TG1</b>	Timer giornaliero a cavalieri interno quadro	In-box daily Timer with switch rider	Programmateur journ. à cavaliers à l'intérieur du coffret
105.51	<b>TS1</b>	Timer settimanale digitale	Weekly digital timer	Programmateur hebdomadaire numérique
105.52	<b>TM1</b>	Timer multifunzione	Multifunction timer	Programmateur multifonction
105.54	<b>TMPL</b>	Timer pausa lavoro	Start and stop controller	Programmateur pause/travail
105.55	<b>CO/C</b>	Contaore	Hour counter	Compteur horaire
111.00	<b>V 500C</b>	Kit Voltmetro 500 VFS	500 V Voltmeter	Kit voltmètre 500 VFS
111.01	<b>A 25C</b>	Kit Amperometro fno a 25A FS	25A Ammeter kit	Kit ampèremètre jusqu'à 25A FS
111.04	<b>A 100C</b>	Kit Amperometro fno a 100A FS	100A Ammeter kit	Kit ampèremètre jusqu'à 100A FS
111.08	<b>A 500C</b>	Kit Amperometro fno a 500A FS	500A Ammeter kit	Kit ampèremètre jusqu'à 500A FS
111.091	<b>TR/ADX</b>	Tastiera remota per soft starter	Soft start remote keyboard	Clavier distant pour démarreur progressif
120.51	<b>PMV10</b>	Controllo sequenza e mancanza fasi	Sequence and phase failure wired control	Contrôle de la séquence et de l'absence de phases
121.01	<b>AS/C</b>	Allarme sonoro cablato	Wired acoustic alarm	Alarme sonore câblée
121.02	<b>AST/C</b>	Allarme sonoro con batteria tampone	Acoustic alarm with back up battery	Alarme sonore avec batterie tampon
121.12	<b>AV/C</b>	Allarme visivo cablato	Wired flashing alarm	Alarme visuelle câblée
121.31	<b>SCI/C</b>	Kit centralina irrigazione	Irrigation controller kit	Kit centrale d'arrosage
121.41	<b>3XSL/1</b>	Kit 3 sonde di livello per protezione marcia a secco	Kit of 3 level probes for dry running protection	Kit 3 sondes de niveau pour protection marche à sec
121.61	<b>PMV50</b>	Controllo di sequenza e mancanza fasi, minima e massima tensione	Control of sequence and phase failure, minimum and maximum voltage	Contrôle de la séquence et de l'absence de phases, tension minimale et maximale
121.71	<b>RA3P</b>	Relè alternanza 3 pompe	3 pump exchanger relay	Relais d'alternance 3 pompes
104.78	<b>PMV30</b>	Controllo sequenza mancanza fasi e min. tensione	Phase sequence failure and min. voltage control	Contrôle séquence et absence phases et tension min.

# ANTI-BLACKOUT

**Gamma completa di soccorritori d'emergenza e UPS**

Complete range of anti-blackout system and UPS

Gamme complète de système anti-coupure et UPS

**370 W → 200 kW**



**Soccorritori e UPS per la sicurezza dei tuoi dispositivi!**

*Anti-blackout systems and UPS for the safety of your devices!*

*Systèmes anti-coupure et UPS pour la sécurité de vos appareils!*



# GENERATORS

**Gamma completa di gruppi elettrogeni**

Complete range of gensets

Gamme complète de groupes électrogènes

**1 kW → 1800 kW**



**Gruppi elettrogeni con controllo remoto!**

*Generator sets with remote control!*

*Groupes électrogènes avec commande à distance!*



[fourgroup.it](http://fourgroup.it)

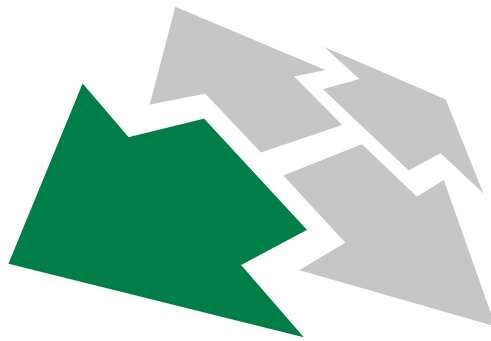

**I dati e le immagini indicate non sono contrattualmente impegnativi, Fourgroup si riserva di modificarli senza preavviso, in ragione del costante aggiornamento del prodotto.**

The datas and images shown are not contractually binding, Fourgroup reserves the right to modify them without prior notice, due to the constant updating of the product.

Les données présentées ne sont pas contractuelles, Fourgroup se réserve la faculté de les modifier sans préavis, en raison de l'actualisation constante du produit.

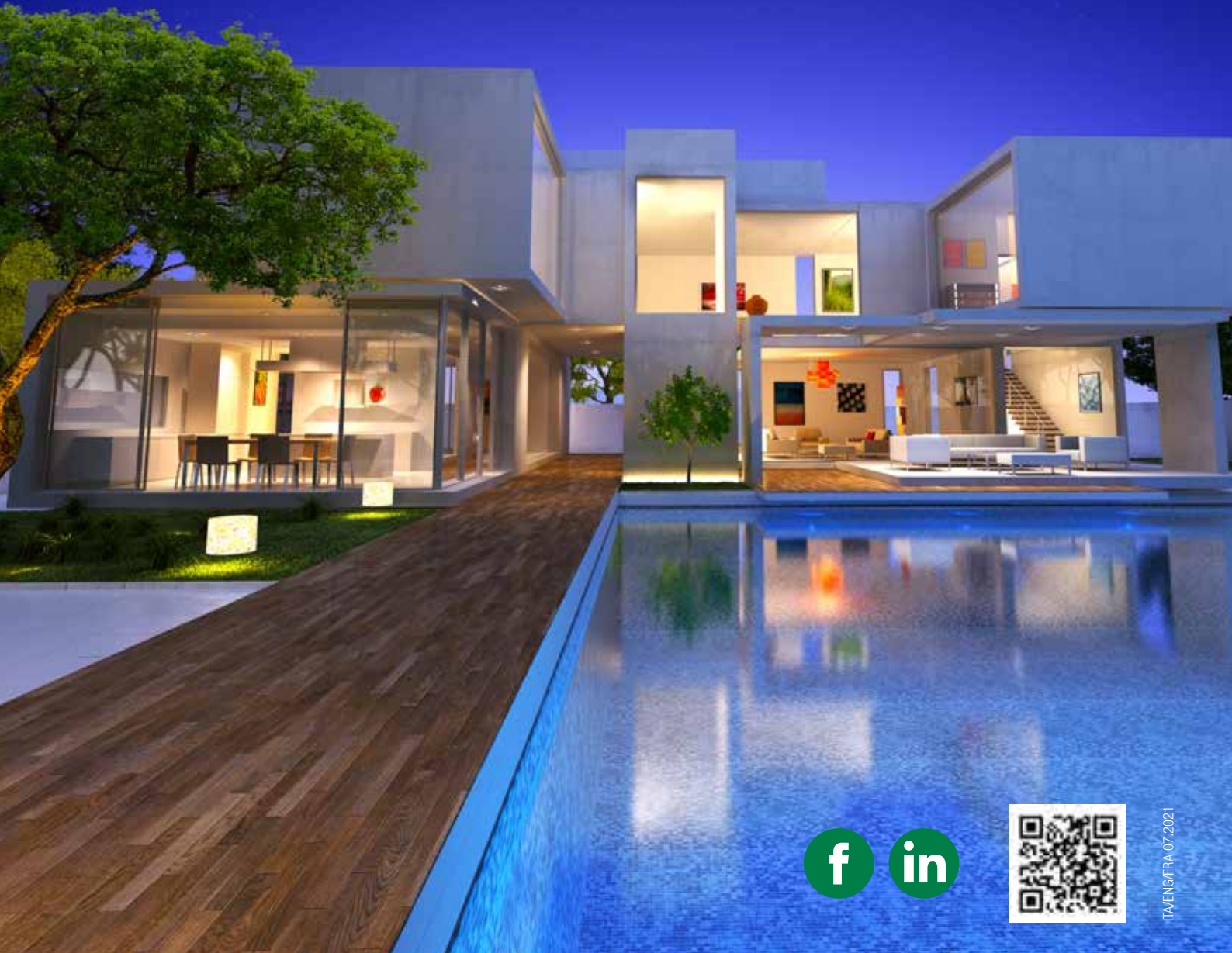

**FOURGROUP sas**  
Via Enrico Fermi, 8  
35020 Polverara (PD) ITALY

Tel. +39 049 9772407  
Fax +39 049 9772289

[www.fourgroup.it](http://www.fourgroup.it)  
[info@fourgroup.it](mailto:info@fourgroup.it)

Distribuito da / Distributed by / Distribué:

